

# THE MICRO USER

Volume 9    Number 7    September 1991    £1.50



## SOFTWARE BREAKTHROUGH

*Program  
compatibility  
is now a  
reality*



**DIG IN**  
Cultivate your garden  
**HARD DISCS**  
Organise yourself better  
**ARCADE ACTION**  
Thrust your way to freedom  
**SYMMETRY**  
Make complex designs easily

**Reviews**  
Junior database  
PC Emulator  
ArcTerm 7  
Arcomm 2  
...plus all the  
latest games



For ALL users of the BBC Micro, Master, Electron, Archimedes series and A3000

# SUPERIOR SOFTWARE

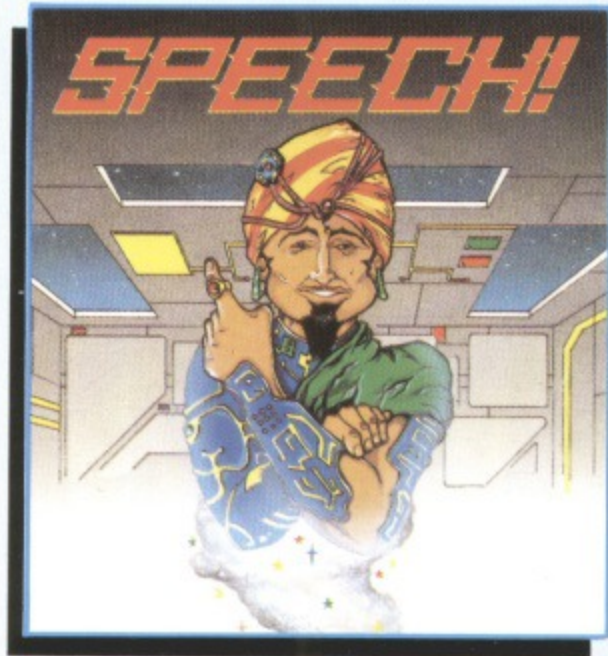

A3000/Archimedes



A3000/Archimedes

## SPEECH!

### Give Your Computer a Voice

SPEECH! works entirely in software, no extra hardware whatsoever is required, and has an unlimited vocabulary. The program has a built-in parser which translates English words into phonemes, so it can directly speak words you input or text files. The phonemes can be used directly if you wish, so stress and intonation can be added as required and even foreign languages can be spoken. SPEECH! includes a user-friendly spelling program, which can be easily changed to include your own words.

The new A3000/Archimedes version of SPEECH! is fully RISC OS compatible and allows multitasking in Desktop. You can vary the pitch, speed, volume, and voice, both directly and in your own text files and programs, and can even 'sing' words over a four octave range! The A3000/Archimedes version also includes a program so you can alter the dictionary yourself.

BBC Micro/Master & A3000/Archimedes

## MASTER BREAK

### Snooker-Style Trivia Quiz Game for 1 to 4 Players

Six categories of questions: SCIENCE & NATURE, POP MUSIC, GEOGRAPHY, SPORTS & PASTIMES, ARTS and HISTORY. Over 1500 questions in the BBC Micro/Electron version. Over 2000 questions in the A3000/Archimedes version, including digitised picture and digitised sound questions.

In the 1 player game, try to get the highest break - you might even manage the maximum break of 147. In the 2 to 4 player game, compete against your friends and family for the highest score and highest break.

Start your frame with an easy red question, then choose your colour - have you the nerve to choose the black ball question? You've used all your PASSES and the ball is OVER THE POCKET - if you miss, it's a FOUL SHOT!

ALL THE FUN AND CHALLENGE OF A TRIVIA QUIZ AND SNOOKER MATCH ROLLED INTO ONE ENTHRALLING GAME.

BBC Micro/Master, Electron & A3000/Archimedes



BBC Micro/Master



A3000/Archimedes

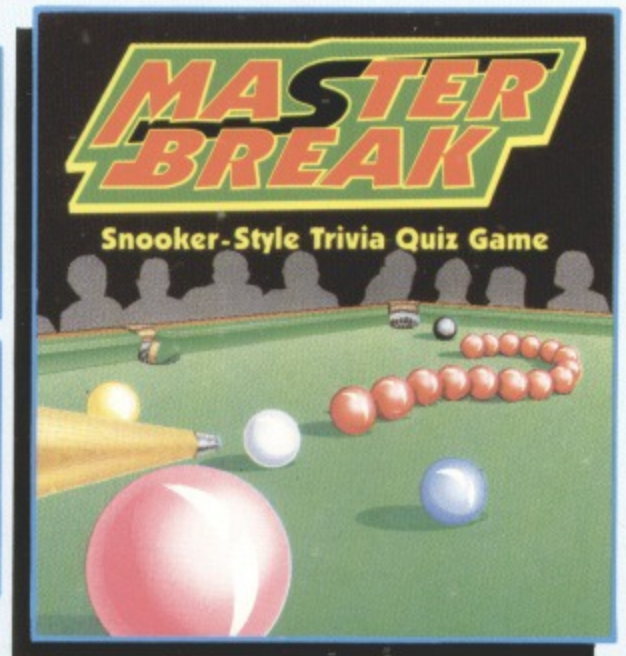

Last Ninja 2



Cyborg Warriors

## PLAY IT AGAIN SAM 15

### A New Action-Packed Four-Game Compilation

#### LAST NINJA 2

The Last Ninja is back with a vengeance! Battling with fists, shuriken stars, swords and lots of other devious weapons, against the evil Shogun in downtown New York.

"Animation is excellent and there's lots of detailed scenery. The puzzles are quite fiendish" ....Micro User.

#### NETWORK

An action-packed 'Top Ten' game by Peter Scott, featuring teleport machines, lifts, springs, strange aliens and lots, lots more. Shoot your way through more than 100 different screens as you attempt to collect the twenty parts of the 'Flynche' machine. Nerve-tingling excitement.

BBC Micro/Master & Electron

#### CYBORG WARRIORS

A brand-new release by Superior. A multi-level, sideways scrolling shoot-em-up, with lots of weird robots and monsters to shoot, and tokens to collect which can give more powerful weapon systems. The BBC Micro/Master version has a joystick option, which allows two players to battle together.

#### RICOCHET

A massive arcade adventure with brilliant graphics, as you control SPRAT, the Small Partially Robotic Alien Time-traveller. Five different levels: FORTRESS, TECHLEV, DERELICT, THE UFO and ANCIENT.

"A superb problem-solving game. A must for your games collection" ....BBC Acorn User.

### SPEECH!

BBC Micro Cassette .....\$9.95 BBC Micro 5 1/4" Disc.....\$11.95  
Master Compact 3 1/2" Disc.....\$14.95 A3000/Archimedes 3 1/2" Disc.....\$19.95

### MASTER BREAK

BBC Micro/Electron Cassette...\$9.95 BBC Micro 5 1/4" Disc.....\$11.95  
Master Compact 3 1/2" Disc.....\$14.95 A3000/Archimedes 3 1/2" Disc.....\$19.95

### PLAY IT AGAIN SAM 15

BBC Micro/Electron Cassette...\$12.95 BBC Micro 5 1/4" Disc...\$14.95  
Master Compact 3 1/2" Disc.....\$19.95

BBC Micro Cassettes & BBC Micro 5 1/4" Discs are compatible with BBC B, B+ & Master 128 computers. Screen pictures show the BBC Micro versions of the games, unless otherwise stated.

We have in stock over 30 different titles for the BBC Micro/Master and Acorn Electron computers including such great games as: ELITE, REVS + REVS 4 TRACKS, EXILE, HOSTAGES, A QUESTION OF SPORT, REPTON INFINITY, PERPLEXITY and SIM CITY, and the compilation titles: ACORNSOFT HITS 1 & 2, SUPERIOR COLLECTIONS 1, 2 & 3 and PLAY IT AGAIN SAM'S 1 to 14. All are available for immediate despatch

Our A3000/Archimedes titles include great classics such as ZARCH, CONQUEROR and REPTON 3 (now with enhanced graphics), and the new highly praised golf simulation/designer, SUPERIOR GOLF. Also the action-packed HOSTAGES game.

Please write to the address below or telephone for a full list of Superior Software games.



(Superior Software is a trading name of Superior Microcomputing Ltd.)  
Dept. Q2, P.O. Box 6, Brigg, S. Humberside DN20 9NH. Tel: (0652) 58585

PLEASE MAKE CHEQUES PAYABLE TO "SUPERIOR SOFTWARE."



24 HOUR TELEPHONE ANSWERING SERVICE FOR ORDERS

#### OUR GUARANTEE

- All mail orders are despatched by first-class post
  - Postage and packing is free
  - Cassettes and discs that are faulty on receipt will be replaced immediately
- (This does not affect your statutory rights)

Today you want a hard disc. 45Mb should be enough, after all you're managing quite well with floppies, and anyway you could never afford anything fancy like a CD ROM or a Magneto-Optical drive, and tape backup is really only a luxury when it doesn't take that long to backup 45Mb to floppy disc.

You may have thought the same when you bought a cassette deck for your Model B. How things change!

However, there is one big difference between then and now. Now, it doesn't cost a fortune to 'future-proof' your expansion options.

With Oak Solutions' 16 bit SCSI systems, you can add a hard disc to your computer from only £299, and yet when prices fall, you can add a Magneto-Optical drive, you can add CD ROM drives, you can add Cassette, Cartridge and DAT Streamers, you can add Flatbed Scanners, you can add Hard Discs of up to 2 Gigabytes capacity.

What about speed? The fastest hard disc we have yet found can transfer data through our SCSI card into Archimedes memory at 1.9Mbytes per second *sustained*— that's faster than RAM on many systems. Today, these speeds are only needed for things like fast realtime data capture and multi-channel digital audio – but what about tomorrow?

Remember, all our SCSI products are manufactured and tested to the exacting standards imposed by our 'zero defect' quality control regime. We don't cut costs by missing out important components like fans, and we don't ignore the future!

# Buying a Hard Disc?

## Think about the Future



## The Intelligent Choice

### 16 Bit SCSI

**Quality  
Reliability Compatibility  
Performance**

#### Worra Winnie Range

##### Internal Drives for 300/400 series

20Mb	299.00
45Mb	399.00
80Mb	495.00
100Mb	599.00
200Mb	875.00

##### External Drives for 300/400 series and A3000

20Mb	344.00
45Mb	445.00
80Mb	545.00
100Mb	649.00
200Mb	925.00

#### High Speed Range

##### Internal Drives for 300/400 series

50Mb	425.00
100Mb	625.00
200Mb	975.00

##### External Drives for 300/400 series and A3000

50Mb	549.00
100Mb	749.00
200Mb	1095.00

#### Elite Range

##### External Drives for 300/400 series and A3000

50Mb	750.00	300Mb	1850.00
100Mb	950.00	680Mb	2500.00
200Mb	1300.00	Mag-Opt	4800.00

Please specify type of computer when ordering.

Add £10 to cover P&P. Prices exclude VAT



Telephone for Education Prices

# THE MICRO USER

Managing Editor  
Derek Meakin

Publisher  
Peter Glover

Features Editor  
Steve Turnbull

Art Editor  
Tym Leckey

Reviews Editor  
Pam Turnbull

Technical Editor  
Mike Cook

Chief Sub Editor  
Claire Walls

Group Advertisement Manager  
John Snowden

Advertising Sales  
Yvonne Benson  
Peter Babbage  
Advertising Production  
Simon Williams

Marketing Manager  
John Weir

Circulation Director  
John Burns

Circulation Manager  
David Wren

Systems Manager  
Dave Stewart

Tel: 0625 878888 (All depts.)  
051-357 2961 (Subs.)

Telex: 94081191  
Fax: 0625 879966

**EUROPRESS**  
PUBLICATIONS

Europa House, Adlington Park,  
Macclesfield SK10 4NP.

**ABC** 24,365  
January-June 1990  
ISSN 0265-4040

The Micro User welcomes new program listings and articles for publication. All material should be supplied on disc or tape and printed. Please enclose a stamped, self-addressed envelope, otherwise the return of material cannot be guaranteed. Contributions accepted for publication will be on an all-rights basis.

The Micro User is an independent publication and neither the BBC nor Acorn Computers Ltd are responsible for any of the articles in this issue or for any of the opinions expressed.

© 1991 Europress Publications Ltd. No material may be reproduced in whole or in part without written permission. While every care is taken, the publishers cannot be held legally responsible for any errors in articles, listings or advertisements.

News Trade Distribution: UMD 071 700 4600



## COVER STORY

### Act on Impulse

AND application shall speak unto application, a completely new inter-task communication system is under development that could revolutionise the way programs are written and used. Find out all about it on Page 96.

## SPECIALS

47

### Game diary

The everyday story of programming folk: The trials and tribulations of a part-time games writer.

57

### Vegetables

Get down and dig in with this handy aid to producing garden comestibles.



63

### Mode to mode

Converting a 16 colour Mode 2 screen into Mode 1 is easy when you use this excellent utility.



82

### Thruster

Arcade action in the depths of an alien planet – can you get out alive?



## Type-it-in

This symbol indicates that the feature contains at least one full length listing for you to key in on your micro.



All the major listings in this magazine are accompanied by checksums to help you key them in correctly.

Get it right ✓

For full details of how to use them see the article on page 56 of the February 1991 issue.

## MICRO USER CLASSIFIEDS

The best bargains in the world of all Acorn micros come from readers of The Micro User. Turn to Page 106 to find just what you're looking for – from cheap modems to complete computer systems.

## EDUCATION

25

### Update

Up-to-the-minute news of the Acorn range of micros in use in the world of education.

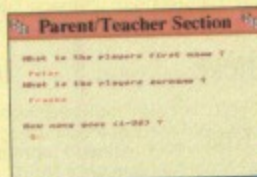

27

### Reviews

Catch up on the latest software for the BBC Micro series in schools, including:

- Viewpoints
- Leaving the Earth
- Farmer Giles

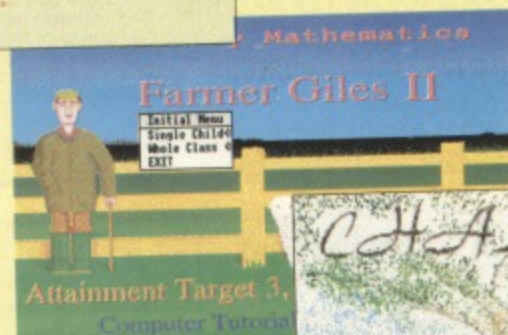

Attainment Target 3,  
Computer Tutoria



REGULARS: News 9 ● Hac Man 18 ● Body

# COMPETITIONS

WIN the Computer Concept's Scan-Light Junior 256 – the photographic quality 256 grey-levels scanning system for the Archimedes. Turn to Page 95 to find out how.  
 WIN a great package from Apricote Studios and keep track of your money, Personal Accounts is for 8 bit BBC Micros, Archimedes or BBC A3000. Turn to Page 67.

# FREEBIES

WOULD you like some commercial software for free? Find out how you can get it on Page 88.

## Newcomers

**87** **Tiling**  
 Create fascinating patterns from a simple grid of triangles, made easy with this simple program.



**91** **Comms software**  
 Arcomm 2 and ArcTerm 7 shoot it out across the telephone lines in our comparative review.

**93** **Master 512**  
 Is your Acorn PC-clone not compatible enough? Here's two products that can help you out.

**99** **Junior Database**  
 Don't be fooled by the name, this easy to use product has a lot going for it.

**101** **PC Emulator**  
 Windows within windows are now possible with this superb upgrade of the original PC Emulator.

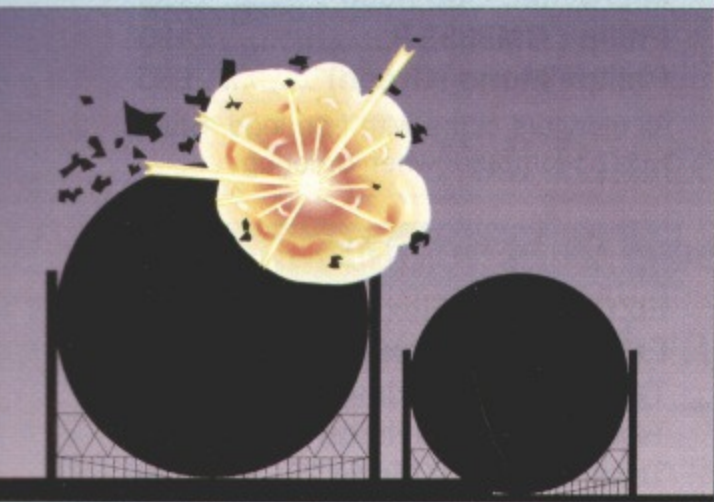

**Software SCENE 40**

Our experts delve into what's among the latest games releases



### Three months' free reading!

That's what we are offering new subscribers. And that's not all, for month after month with your subscription you'll receive FREE software, including listings from the latest issue.

On this month's subscription disc or tape:

- Veg! The cultivation program
- Tiling generator
- Plus all type-in listings

In addition, those readers with a BBC A3000 or Archimedes series machine will also get:

- New Virus Killer, version 2.30
- Plus over 1 Mb of PD software



For new subscribers there's a special gift: A free binder to keep your copies of *The Micro User*.

Find out how to subscribe on Page 104

## NEXT MONTH IN THE MICRO USER

The amazing Tai-pei game has now migrated to the BBC Micro and you can type it in next month. There's lots of handy utilities for all Acorn machines plus our PD section full of great money-saving ideas.



# Dabhand Computing Ltd.

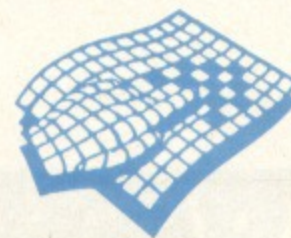

TERMS: UK residents add 17.5% VAT to all prices, except books. Delivery FREE on all postal items in the UK. Foreign orders, no VAT, carriage at cost. (quotations available). Access/Visa cards accepted. Dabhand Computing Ltd. is a Qualified Acorn dealer. Official orders accepted from public sector/education/PLCs, otherwise cash with order. Tender invitations welcome. Callers welcome. We are 800 yds north of J17, M62. Fax: 061-766 8425. Prices subject to change without notification. Goods offered subject to being unsold.

Dabhand Computing Ltd, 5 Victoria Lane, Whitefield, Manchester M25 6AL. This advert was produced using Impression from Computer Concepts.



## Archimedes Computers

<b>A 3000 2Mb Ram</b> .....	<b>£599.00</b>
<b>A 3000 LC 2Mb Ram *</b> ....	<b>£699.00</b>
<b>A 410/1</b> .....	<b>£1099.00</b>
<b>A 420/1 LC **</b> .....	<b>£1299.00</b>
<b>A 440/1</b> .....	<b>£1699.00</b>
<b>A 540</b> .....	<b>£2995.00</b>

We can match or improve on prices advertised or quoted in or from this magazine please phone for the best deals.

**We operate the Acorn Schools, Academics & Finance schemes.**

\* Pack includes PC Emulator, 1st Word Plus, Genesis. \*\* + Acorn DTP.



## Oak SCSI Devices

Worra Winnie	
20 Mb Internal Hard Disc .....	£299
45 Mb Internal Hard Disc .....	£399
80 Mb Internal Hard Disc .....	£599
100 Mb Internal Hard Disc .....	£795
200 Mb Internal Hard Disc .....	£1195
20 Mb External Hard Disc .....	£349
45 Mb External Hard Disc .....	£449
80 Mb External Hard Disc .....	£649
100 Mb External Hard Disc .....	£845
200 Mb External Hard Disc .....	£1245
High Speed Range	
40 Mb Internal Hard Disc .....	£495
80 Mb Internal Hard Disc .....	£675
100 Mb Internal Hard Disc .....	£995
200 Mb Internal Hard Disc .....	£1545
45 Mb External Hard Disc .....	£685
80 Mb External Hard Disc .....	£865
100 Mb External Hard Disc .....	£1185
200 Mb External Hard Disc .....	£1735
60 Mb Tape Streamer .....	£795



## Archimedes A400

5.25" Ext. floppy disc interface .....	£30
A 540 4Mb Ram Upgrade .....	£449
Additional 3.5" Floppy Disc .....	£119
ARM 3 Upgrade (Aleph 1) .....	£369
ArVis S-VHS Video Cont. Board .....	£295
ArVis S-VHS Encoder Board .....	£145
ArVis Video Graphics Board .....	£877
Atomwide 8 Mb Memory Upgrade .....	£850
Chroma 345 Overlay Board .....	£389
Dongle Dangle (Impression/Oak) .....	£6
Econet Module .....	£46
Ethernet Expansion Card .....	£249
Floating Point Expansion Card .....	£449
Hawk V9 Video Digitiser .....	£339
I/O Expansion Card .....	£79
Keyboard Extender .....	£8
Midi Upgrade to I/O Exp. Card .....	£27
Midi Expansion Card .....	£65
Mouse (New Style) .....	£40
Scanlight Junior Scanner A6 (CC) .....	£179
Scanlight Junior 256 Grey Level (CC) .....	£199
Scanlight Senior Scanner A4 (CC) .....	£349
Sheet Feeder for above A4 (CC) .....	£105
SCSI Expansion Card (Acorn) .....	£229
TCP/IP Ethernet .....	£199
VIDC Enhancer .....	£29



## Dabhand 410/1 to 420/1

Acorn A410/1 upgraded to A420/1 specification using only the highest quality Samsung Ram and a 20 Mb Seagate ST-125-1 28ms drive or Acorn drive formatted and tested for guaranteed trouble free use.

<b>A410/2 20 Mb</b> .....	<b>£1099</b>
<b>Colour System</b> .....	<b>£1289</b>
<b>Eizo 9060 SZ System</b> .....	<b>£1499</b>

## Dabhand 410/1 to 440/1

Acorn A410/1 upgraded to A440/1 specification using a Branded 40 Mb 28ms drive formatted and tested as above.

<b>A440/1 specification</b> .....	<b>£1299</b>
<b>Colour System</b> .....	<b>£1488</b>
<b>Eizo 9060 SZ System</b> .....	<b>£1699</b>

## Dabhand ST506 Hard Disc Drives

**Archimedes A410 Internal Hard Disc Drives** for use with 'on-board' ST506 winchester controller. Comes complete with mounting chassis, screws, connecting cables and easy to follow fitting instructions.

<b>20 Mb 28ms</b> .....	<b>£129</b>
<b>40 Mb 28ms</b> .....	<b>£245</b>

## A3000 SCSI Devices

Please refer to Oak External SCSI prices in the opposite column as prices for A3000 external units are the same.

## A3000 Ram Upgrade

<b>Atomwide Ram Upgrades</b>	
<b>1 Mb Ram Upgrade</b> .....	<b>£56</b>
4Mb upgrade to above board .....	£130
<b>4 Mb Ram Upgrade</b> .....	<b>£159</b>

## A3000 Upgrades

5.25" External floppy disc cable .....	£15
5.25" External f/disc buffer (Pres) .....	£46
5.25" External f/disc buffer (Beebug) .....	£39
Dust cover (Keyboard + Monitor) .....	£12
User & Analogue Podule .....	£46
Monitor Stand (Acorn) .....	£29
Monitor Stand (Pres) .....	£24
Mouse Extender (No more fiddling) .....	£8
Serial Upgrade .....	£19
Serial Link Kit (BBC-Arc) .....	£14
User & Midi Podule .....	£46
VIDC Enhancer .....	£29

## A400 Series Ram Upgrades

**Fast Samsung Ram** complete with step by step fitting instructions, or fitted FREE on our premises by our Engineer.

<b>1 Mb Ram</b> .....	<b>£35</b>
<b>2 Mb Ram</b> .....	<b>£65</b>
<b>3 Mb Ram</b> .....	<b>£99</b>

## Standard Monitors

<b>Acorn Colour</b> .....	<b>£199</b>
<b>Microvitec Cub 3000</b> .....	<b>£199</b>
<b>Philips CM8833 II</b> .....	<b>£199</b>
<b>Philips Mono (Green)</b> .....	<b>£85</b>

All monitors come with free lead. State type of computer when ordering.

## Multiscan Monitors

<b>EIZO 9060SZ Flexiscan</b> .....	<b>£399</b>
<b>EIZO 9070SZ Flexiscan ^</b> ....	<b>£599</b>
<b>Taxan 775 Multivision</b> .....	<b>£389</b>
<b>Taxan 795 Multivision ^</b> .....	<b>£465</b>
<b>Taxan Viking II Mode 23</b> ....	<b>£749</b>

^ comes with free VIDC enhancer.

## Master 128

<b>Master 128</b> .....	<b>£369</b>
-------------------------	-------------

## Floppy Disc Drives

5.25" Single 40/80 no psu .....	£95
5.25" Single 40/80 with psu .....	£109
5.25" Dual 40/80 no psu .....	£185
5.25" Dual 40/80 with psu .....	£199
3.5" Single with psu .....	£85
3.5" + 5.25" 40/80 no psu .....	£185
3.5" + 5.25" 40/80 with psu .....	£209

## Printers

Citizen 120D+ (Serial add £20) .....	£129
Citizen Swift 9 .....	£179
Star LC10 .....	£139
STAR LC200 COLOUR (9 pin) .....	£199
CANON Bubblejet BJ-10e .....	£289
Canon Bubblejet BJ-130e .....	£449
Sheetfeeder for BJ-10e .....	£59
Citizen Swift 24 .....	£249
Colour Kit for above (also Swift 9) .....	£39
STAR LC24 - 200 .....	£239
STAR LC24 - 200 COLOUR .....	£289
Sheetfeeder for LC24 - 200 .....	£69
Integrex Colourjet 132 .....	£519
HP Paintjet .....	£795
LASER DIRECT (Qume) .....	£859
LASER DIRECT (LPB8 Hi Res.) .....	£1299





# Midnight Graphics Products

## Clip Art - Draw Files

Give your DTP documents the right balance with Midnight Graphics Clip Art.

Over 480 Draw file images, presented in a library of five discs.

Change the images in !Draw to suit your style and purpose. Then place them into Impression or Acorn DTP.

**Clip Art . £29.95**

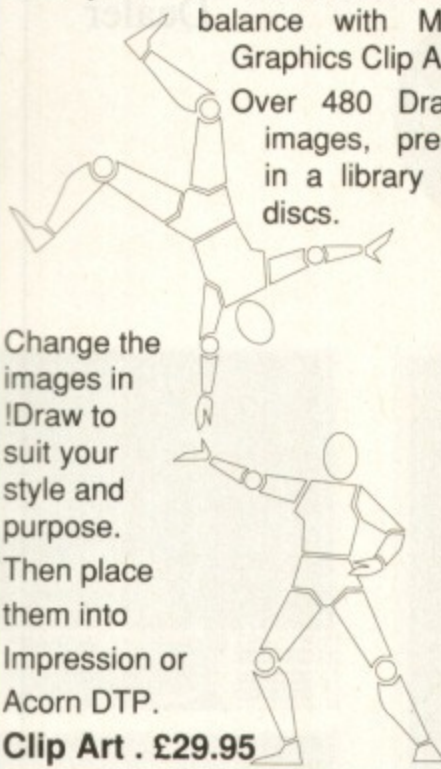

## Clip Art - Set 2

Clip Art Set 2 - Now Available  
Draw file Clip Art - Completely rotatable, scalable - no loss of resolution.

**Clip Art 2 ..... £29.95**



## Full Range of

## Educational & Special Needs

## Software Available

4Mation, Chalksoft, Longman, Sherston, Widgit  
And many more ...



## Books (No Vat)

C: A Dabhand Guide ..... £14.95  
 Archimedes Assembly Language ..... £14.95  
 Archimedes Operating System ..... £14.95  
*The above books have accompanying discs add £5 for 5.25", £7 for 3.5"*  
 A3000 Technical Guide ..... £29.95  
 A540 Technical Guide ..... £65.00  
 Acorn DTP Advanced U.G. .... £14.95  
 Archimedes First Steps ..... £9.95

BASIC V: A Dabhand Guide ..... £9.95  
 BBC Basic Guide (Acorn) ..... £19.95  
 DTP Seeds (4Mation) ..... £8.45  
 128 Ref. Man.Pts 1&2 ..... (ea.) £14.95  
 New Advanced User Guide ..... £19.95  
 RISCOS PRM's ..... £79.00  
*Additional Arc Software Manuals (Acornsoft)*  
 First Word Plus, DTP, Assembler . (ea.) £10  
 ANSI C Version 3 ..... £19

## Printer Drivers

Midnight Graphics  
 Citizen Swift 9 Sprite Dump ..... £26.04  
 Citizen Swift 24 Sprite Dump ..... £26.04  
 Epson 24 Sprite Dump ..... £26.04  
 HP Paintjet Sprite Dump ..... £26.04  
 Integrex 132 Sprite Dump ..... £26.04  
 Integrex Colourcel Sprite Dump ..... £26.04  
 Juki 5520 Sprite Dump ..... £26.04  
 Star LC10 Sprite Dump ..... £26.04

Star XB24 Sprite Dump ..... £26.04  
 Star LC200 Sprite Dump ..... £26.04  
 Star LC24-200 Sprite Dump ..... £26.04  
 Ace Computing  
 Printer JX ..... £13.00  
 Printer PJ ..... £13.00  
 Printer CA ..... £13.00  
 Electronic Font Foundry  
 BubbleJet - BJ10e/130e ..... £10.00

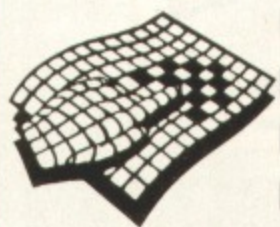

- ◆ Acorn Qualified Dealer
- ◆ Acorn Component Level Service Centre
- ◆ Specialists in Education
- ◆ Friendly Professional Service



## Software

ANSI C V.3 Compiler + free C Guide .....	£130.00
Apocalypse (3D Space Game) .....	£14.00
Arc DFS (DFS Filing System) .....	£22.00
ArcTerm (Serial Port) .....	£59.00
Artisan 2 (16 Colours) .....	£45.00
Atelier (Minerva 256 Colours) .....	£75.00
BOOGIE BUGGY .....	£17.00
CHESS 3D .....	£14.00
CHOCKS AWAY 2 (Flight Simulator) .....	£15.00
CHOCKS AWAY EXTRA MISSIONS .....	£14.00
CHOCKS AWAY 2 + EXTRA MISSIONS .....	£27.00
Desktop Office (Minerva Integrated Package) .....	£95.00
DROP SHIP (Superb Graphics) .....	£13.00
Euclid 2 (3D Drawing) .....	£50.00
E-Type (Driving Simulation) / Designer each .....	£13.00
Equazor (Equation generating package) .....	£39.00
Family Favorites (Minerva Compilation) .....	£15.00
First Word Plus V2 (Acorn) .....	£65.00
FONT FX (Font Effects for Draw/Impression) .....	£8.65
Flexfile Relational Database (Minerva) .....	£110.00
GRAPHBOX with Hotlink to Pdream 3 .....	£60.00
Holed Out, Extra Courses, Designer each .....	£13.00
HOSTAGES (Superior) .....	£14.00
IMPRESSION 2 (Document Processor) .....	£125.00
IMPRESSION JUNIOR (Easy DTP) .....	£70.00
IMPRESSION BUSINESS SUPPLEMENT .....	£45.00
Inertia (4th Dimension) .....	£13.00
INTERDICTOR 2 (Flight Simulator) .....	£25.00
Investigator (The Best Disc Copier) .....	£22.00
IRON LORD .....	£14.00
MINI HYPERPACKS (3 games p p) No's 1 to 4 .....	£15.00
Hyperpack (12 Games) .....	£60.00
Maddingly Hall (Minerva Adv.) .....	£13.00
MAD PROFESSOR MARIARTY (Platform game) ..	£14.00
Magnetic Scrolls (Adventures) .....	£22.00
Manchester United .....	£19.00
Microstudio (Emr - Learn Music) .....	£79.00
MIG 29 (Flight Simulator) .....	£28.00
MULTIFS (Arxe Systems - Atari, PC, DFS) .....	£27.00
Multistore Database (Minerva) .....	£195.00
NEVRYON (Unbelievable Graphics & Gameplay) ...	£14.00
PC Emulator + free Shareware .....	£99.00
Pipedream 3 (WP) .....	£115.00
Pipe Mania (Addiction beyond belief) .....	£16.00
POSTER (Superb effects) .....	£75.00
POWERBAND (3D Formula 1 Racing - 4th Dim.) ...	£16.00
ProArtisan (256 Colours) .....	£70.00
REAL MCCOY 2 (4 Game Compendium) .....	£20.00
Render Bender (Clares) .....	£55.00
RHAPSODY 2 (Clares Music package) .....	£45.00
SALOON CARS (Driving Simulation) .....	£18.00
SCHEMA (Multitasking Spread Sheet) .....	£90.00
Superior Golf .....	£12.00
SUPERIOR SPEECH .....	£14.00
STUDIO 24 PLUS (EMR New Risc Os Version) ...	£149.00
TEENAGE MUTANT TURTLES (Colouring Book) ..	£14.00
The Wimp Game (Desktop Adventure 4th Dim.) ....	£14.00
Tracker (Make Great Music) .....	£37.00
Twin World .....	£14.00
WONDERLAND (The Ultimate Adventure) .....	£24.00
Worra Battle (Oak Tank Battle) FREE Headphones	£14.95
WorraCad (Oak 2D Draughting Package) .....	£75.00
Worra Plot (Draw/HPGL Plotter Driver) .....	£25.00

## How to find us



### Hours of Opening

Monday - Friday 9.00 a.m. - 5.00 p.m.  
Saturday 10.00 a.m. - 5.00 p.m.

**NO Minimum Order Value  
NO Carriage Charges in  
Mainland UK**

**ALL Goods Despatched  
within 24 Hours  
Subject To Stock Levels**

**TEL: 061 766 8423**



# The Complete Upgrade Solution

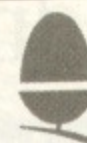

Qualified  
Dealer

A3000



- Uses only eight RAM devices
  - User upgradeable from 1 to 4 Mb
  - Four layer printed circuit board
  - Low power consumption
  - Available without RAM devices
- Bare card - £35 2nd Mb - £56 4th Mb - £159**

A310



- Includes MEMC1a upgrade
  - Large capacity OS ROM sockets
  - No soldering required
  - Four layer printed circuit boards
  - Courier collection of your machine
- 2nd Mb - £225 4th Mb - £299**

A400



- 400 series RAM upgrade kits
  - Supplied with full fitting instructions
  - 410/1 to 420/1 requires 1Mb
  - 420/1 to 440/1 requires 2Mb
  - 410/1 to 440/1 requires 3Mb
- 1Mb - £35 2Mb - £65 3Mb - £99**

8Mb



- Uses only eight RAM devices
  - Suitable for A440, A400/1 & R140
  - Fully RISC OS compatible
  - Four layer printed circuit boards
  - Courier collection of your machine
- 8 Mb upgrade - £649**

ARM3



- New series Aleph One ARM3
  - 3 to 4 times performance increase
  - Surface mount technology
  - Four layer printed circuit board
  - Courier collection of your machine
- ARM 3 upgrade - £399**

VIDC



- Increases resolution with all Multiscan monitors
  - Doubles desktop work area
  - Custom modes for Taxan and Eizo monitors
  - Suitable for all Archimedes computers
  - Free with any multiscan monitor from Atomwide
- Atomwide VIDC Enhancer - £29**

DISC



- Syquest removable disk systems
  - Including One cartridge, drive unit and all cables
  - 42Mb removable cartridges
  - High-flow fan fitted for improved cooling
  - Please phone for prices on other SCSI related products
- Atomwide Syquest drive unit - £470 42Mb disks - £64**



- All products are cross-compatible
  - Combination deals available on all products
  - Typical combination A310 4 Mb and ARM3 £675
  - Dealer enquires welcome
  - Phone for full details on all products
- All prices exclude VAT at 17.5% but include delivery**

## ATOMWIDE

23 The Greenway Orpington Kent BR5 2AY Tel 0689 838852 Fax 0689 896088





# NEWS BEAT



## Join the Arc Elite!



AS revealed by the Mad Hatter exclusively in the August issue of *The Micro User*, the Archimedes version of Elite is almost here.

The best-selling game ever in any computer format, Elite originated on the BBC Micro and was quickly copied and converted to other computers. With its unique blend of arcade action and trading among thousands of star systems, it is the standard against which other games are measured.

An open-ended game, there is no overall aim apart from survival and reaching the ultimate accolade of joining the elite.

To do this you must trade between planets, buying high tech goods for

sale on low tech planets and vice versa. While superficially similar to the BBC Micro version, Arc Elite has numerous changes that enhance its playability and attraction.

In the original you were the centre around which everything happened, but now things can occur without your interfering. For example, a Police Viper may be found chasing a pirate, or asteroid miners will be hard at work as you pass by.

Almost every aspect of the game has been enhanced to some degree, but we won't give all the secrets away. Just look at these screen shots and imagine how much better Arc Elite can be – and keep your eye on *The Micro User* for details.

# IDE Hard Disc Upgrades for the Archimedes & A3000

*A revolution in  
hard disc  
expansion*

## What is IDE?

IDE (Integrated Drive Electronics) is the latest interface standard for connecting hard disc drives to personal computers. Unlike previous interfaces it incorporates much of the circuitry on to the drive itself, greatly simplifying the interface electronics.

## How fast is IDE?

The IDE interface uses a full sixteen bit data bus that allows very high transfer rates between the drive and computer. This coupled with cache memory on the drive itself provides for an Archimedes hard disc system that is typically 50% faster than the standard Acorn ST506 hard disc interface.

## What drive options are available?

### Archimedes 310, 440, 400/1 and 540.

Drive sizes currently available are 42, 89 and 105 Mbyte with a typical access time of 28ms for the 42Mb models and less than 20ms for the others.

These 3.5" drives are available as either internal or external units, and use our high speed 16 bit IDE interface card that fits in your podule backplane. External drives are attractively boxed with their own internal power supply and fan. You may even use both an internal and external drive from the same interface if required.

### A3000

The external drives above are also suitable for the A3000, used in conjunction with the 16 bit interface card that fits in the A3000 podule slot. We are also able to offer internal IDE drives for the A3000 that fit into the internal podule slot. These special 2.5" drives are available in 20 and 42 Mbyte formats and have access times of 23ms.

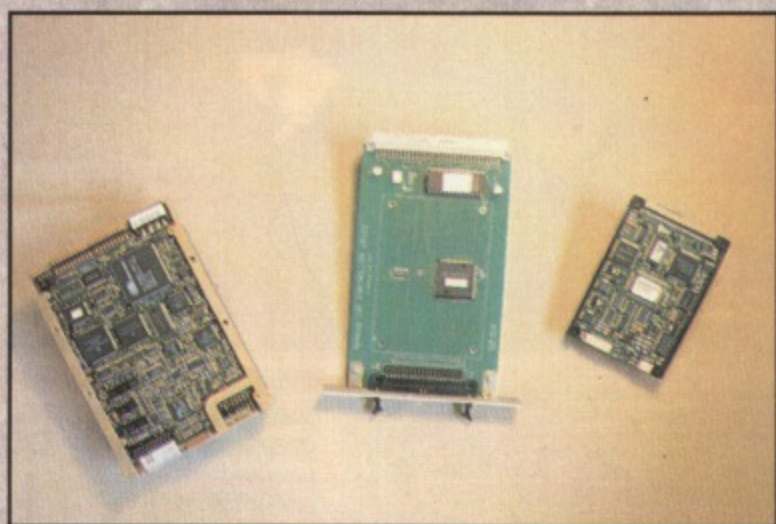
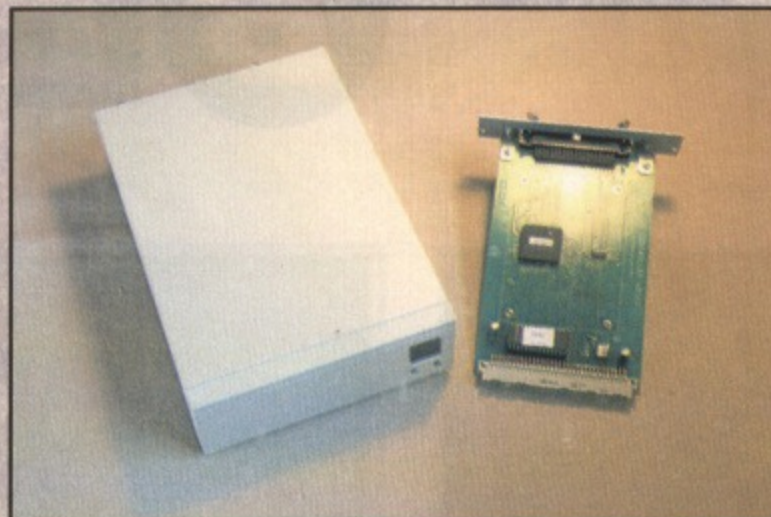

## Will my existing software work with IDE?

The careful design of RISC OS and IDEFS, our IDE filing system, ensures that all RISC OS compliant software will function perfectly with IDE drives. Some older software may need minor changes, but these are documented in the user guide. There are no hidden catches!

## Can I add additional drives at a later date?

The IDE interface can support two hard disc drives. Typically, one of these would be fitted internally, and the second unit connected externally via the expansion connector provided on each interface card.

## What does the future hold?

IDE is a relatively new interface standard, but has already gained massive support. The next few months will see drives up to 400Mbyte, with larger capacities, and devices such as tape-streamers following very soon. The future for IDE is very bright indeed.

## Quality

You may have total confidence in our products. Only the best drives from recognised manufacturers are used, Conner, Seagate, NEC etc. All drive kits are supplied with full fitting instructions and a user guide to ensure that you will have no problems at all. Our interface conforms fully with Acorn's IDEFS specification.

Description	Internal		External		All prices include IDE High Speed Interface.  All prices are Ex VAT  Available from your local dealer, or directly from Beebug (please add £9 carriage).
	Stock Code	Price	Stock Code	Price	
Archimedes 42 Mb	5251	£269.00	5261	£359.00	
Archimedes 89 Mb	5252	£389.00	5262	£479.00	
Archimedes 105 Mb	5253	£499.00	5263	£589.00	
A3000 20 Mb	5270	£375.00	N/A	-----	
A3000 42 Mb	5271	£569.00	5281	£369.00	
A3000 89 Mb	N/A	-----	5282	£489.00	
A3000 105 Mb	N/A	-----	5283	£599.00	

# BEEBUG

Please write or phone for our New A4, 72 page full colour Product Guide.

117 Hatfield Road, St. Albans, Hertfordshire AL1 4JS

Tel. 0727 40303, Fax. 0727 860263

This advertisement was produced entirely with Ovation DTP from BEEBUG

# Gamers get own TV spot

AT last television has acknowledged the huge popularity of computer games. From January next year, Channel Four will run a 10 week series of half hour programmes specially for computer and video gamers.

Called Gamesmaster, it will feature competitions between top players, new games reviews, international charts, hints, tips and cheats and reviews by young players.

It will be produced by Hewland International, the independent production company run by Jane Hewland, former current affairs controller at London Weekend Television.

It is the result of a year of development and research and will cover all home computers and consoles.

"As the mother of an 11-year-old son, I could see quite clearly the enormous growth in popularity of computer and video games", said Jane Hewland.

"All the time we were developing the series, I was terrified someone else would spot what we had spotted and move in ahead of us but we were lucky".

The series has been commissioned by Mike Miller, Channel Four's commissioning editor for sport.

Times and dates have yet to be fixed, but it is likely to have an early evening slot.

# Acorn sales are looking good

FOLLOWING last month's news of Acorn's increasing superiority in the education market, new figures show that they are now one of the top five suppliers of personal computers in the UK, beating both Atari and Apple.

Based on unit sales during 1990, Acorn now have more than six per cent of the market, according to the report from leading computer industry research company IDC.

The IDC figures take in personal computers in their broader sense, as opposed to PCs. They include portables and some workstations, targeting single user systems and those which have been configured to compete

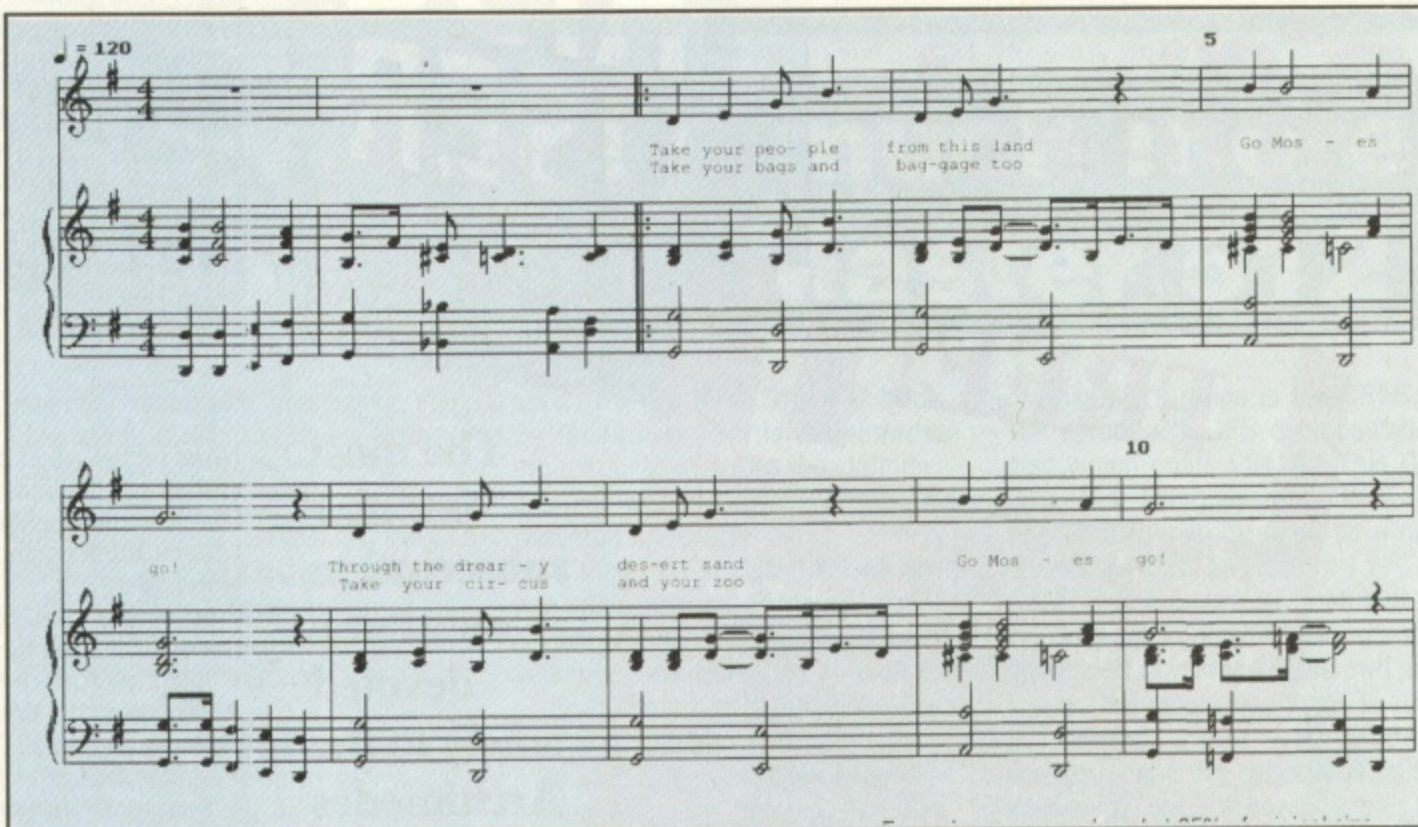

Output from Music Publisher (reproduced courtesy of Smallfax Music)

## Software scores

FOR the first time, high-quality printed music can now be produced on a BBC Micro. This facility is being offered by Hybrid Technology (0223 861522) with its powerful new software package, Music Publisher.

It allows anyone from a music student to the professional composer to enter, edit, store and print out musical scores in a wide variety of formats.

An advance on previous and often more expensive programs, Music Publisher handles the complete process of score layout entirely automatically using built-in data on the complex rules of music notation.

The need for composers to place each note and symbol manually is eliminated by Music Publisher which works out the correct spacing and alignment and positions them precisely to within a fraction of an inch.

The program is rom based, so even on a BBC Micro it can handle scores of up to 3,500 notes. It drives 9 pin and 24 pin Epson-compatible graphics printers with both standard or wide carriages. Price, £60.

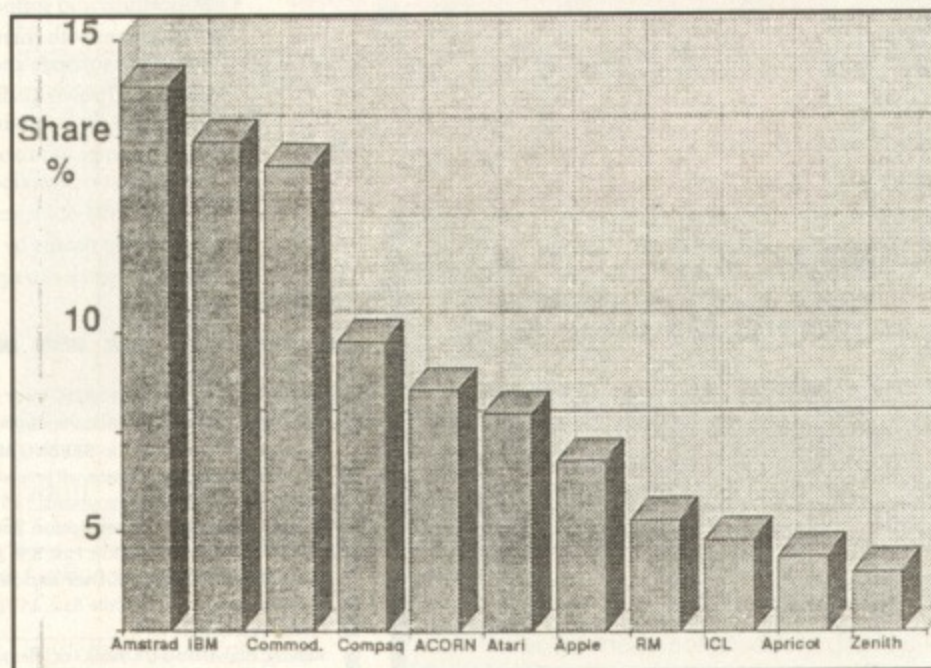

with traditional multi-user systems.

The report was compiled using shipment data from the manufacturers themselves.

Ahead with nearly 15 per cent of

the market is Amstrad, followed by IBM, Commodore and Compaq. Below Acorn with 5.5 per cent is Atari, followed by Apple with 4.3 per cent.

## Picture capture for A3000

ARCHIMEDES and BBC A3000 versions of Solitaire's PC Picture Kit are now available. They provide a portable and simple way of capturing and producing images for manipulation within DTP packages.

The system uses a Canon Ion still frame video camera as its base and is particularly useful in the education field. Solitaire (0480 495608) is also the sole educational distributor of the Epson LCD video projector and has a range of interfaces including one for Archimedes computers.

PC Picture Kit costs £1,250 plus VAT and carriage.



## Now there's much more support for Master 512

ROBIN Burton and Mike Ginns are men with a mission. Through their company, Essential Software, they aim to provide novel and useful software at realistic prices for the small but committed user base of the Master 512.

"I had been a user of the 512 for many years and I always felt somewhat disappointed that it had never been sufficiently supported", said Robin. "If you bought a 512 you were on your own."

"Essential Software was started when I couldn't find a Dos ram disc that worked properly. I produced one myself and other products followed on. It just happened by accident".

The company now has 16 packages for 512 owners and is the largest single supporter of the market.

"Although there are supposed to be between 12,000 and 13,000 users of the 512, I would say our customer base is not much more than 500," added Robin.

"Having said that, we cover this market more comprehensively than anyone else. People using the 512

are often faced with the situation that they either buy our products or they cannot do the tasks they want to.

"Currently the 512 is probably more popular than it ever has been. Although we can't take any credit for this, I think we have woken some people up to using it more regularly. They realise that they now have some support and there is a hard core of dedicated users of the machine.

"The alternative is to buy a full blown PC or to get an Archimedes with the PC Emulator. The 512 is four to five times faster than the Emulator and six times faster than a PC XT – and, of course, it's much cheaper".

Robin is the author of the HyperDriver, MiniDriver and the Master 512 Technical Guide. He also

co-wrote the Mini-Office II book. Better known for his Archimedes products, Mike wrote the definitive machine code reference book ARM Assembly Language.

All their 512 products include support utilities to load, configure, enable, disable or query the various programs and functions from Dos – even for programs that run in the BBC Micro front-end memory.

At £16.95 the package of Ramdisk utilities includes a ram disc that uses 89k less memory than the standard Memdisc supplied with Dos+ 2.1.

Also included is Amnesia, which deletes an empty ram disc without the need to re-boot the system, and DiscID which allows any drive identity to be changed to any other one. Top

of Essential's range is the CPFS, a 16k eeprom with DFS documentation disc which costs £24.95. This Co-Processor Filing System allows the 512's memory to be used as a ram disc for any BBC Micro.

CPFS is a completely standard filing system and can be used with any application or with the users own programs. The data transfer rate is 100k per second – that's five Mode 0 screens – and the capacity is half a megabyte, but can the 512 can be expanded to a full 1Mb. Up to 127 files can be stored in any number of directories.

Contact Essential Software by sending a stamped, addressed envelope to P.O. Box 5, Groby, Leicestershire LE6 0ZB.

## Sound sampling on the Arc

HYBRID Technology (0223 861522) claims to have revolutionised sound sampling on the Archimedes machines by making it easier and cheaper than ever before with its new product, ArcRecorder.

The package contains all the hardware and software needed to record sound for use in music, soundtracks, games, educational materials, multimedia presentations and home-grown programs.

Hardware includes a microphone incorporating on/off switch and desk stand, connected to a small unit which plugs into the parallel printer port. The printer itself plugs into ArcRecorder's pass-on socket so the user can leave both connected at the same time.

Fully compatible with all dongles currently on the market and with Hybrid's AccessLink standard for Archimedes peripherals, ArcRecorder also has a line input for direct

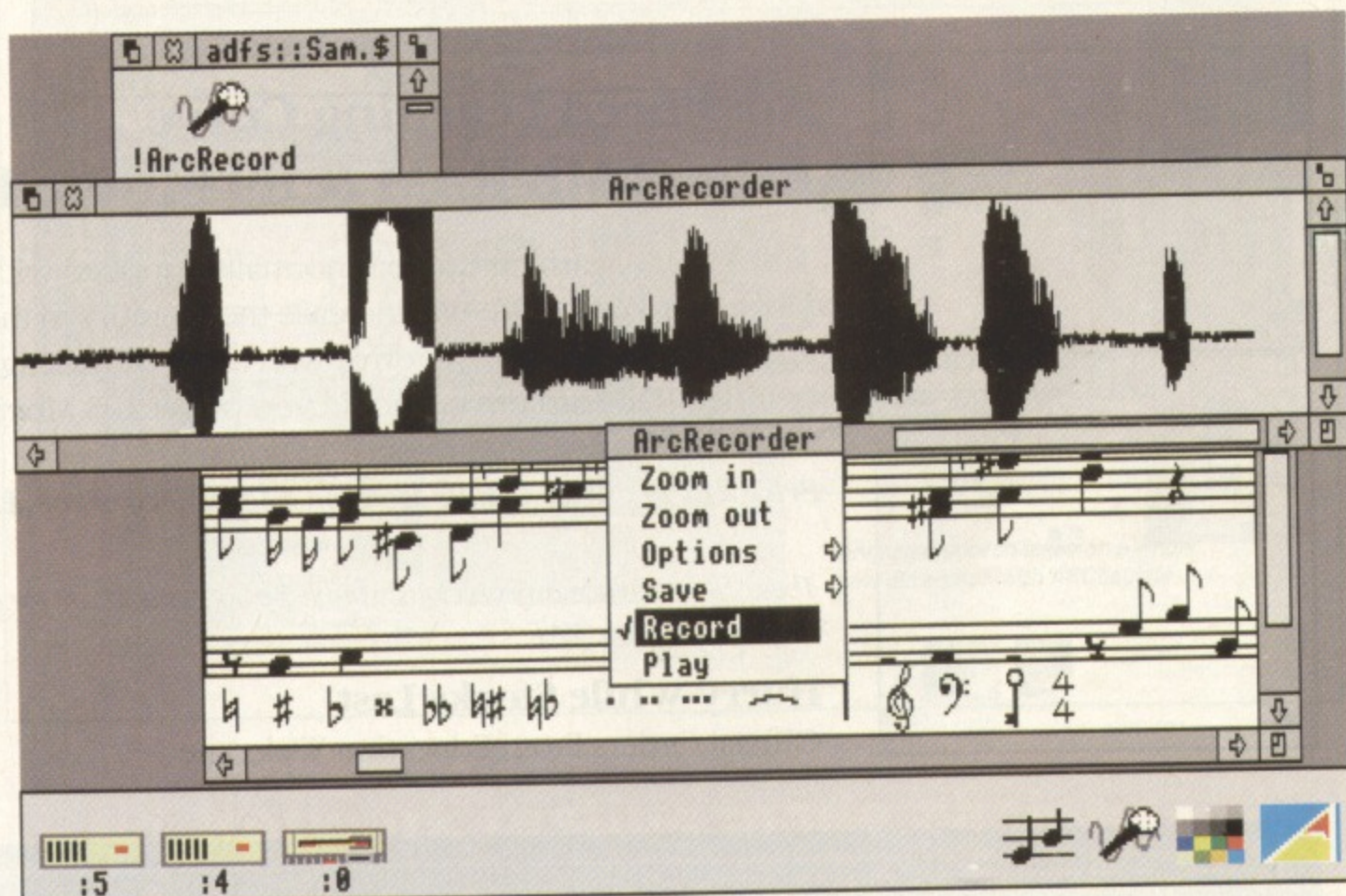

ArcRecorder in action

input from sound players.

"The ArcRecorder software is totally unlike previous sampling software, having been designed to make it as easy as possible to make high quality samples", said Hybrid's Chris Jordan. "The program can operate in

record mode continuously, displaying every sound that it captures on a slowly scrolling on-screen 'tape'.

"To replay a sound, the user simply clicks at the appropriate point on the tape. The program automatically frames each sound, eliminating the

tedious manual editing of start and end positions required in previous programs, so it can be dragged to a disc file or another application immediately".

ArcRecorder costs £38.89 including VAT, post and packing.

# The Product Guide

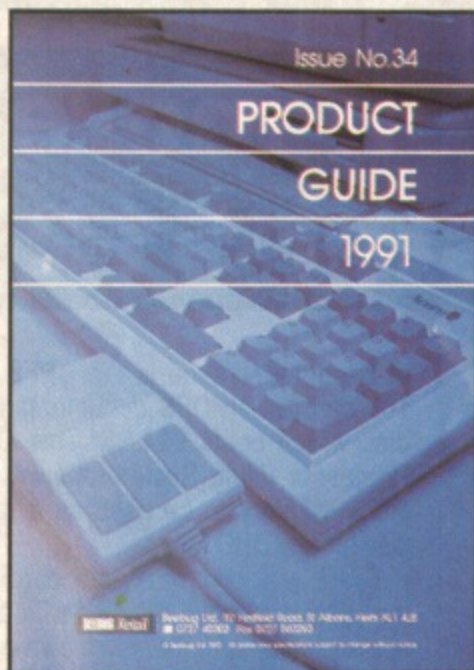

Beebug have published a 72 page full colour A4 product guide for users of BBC, Master, A3000 and Archimedes computers. It contains information on thousands of products that are available now for your computer. Whichever system you use, you will find this illustrated and helpful guide to be an invaluable source of information. Everything is covered from complete systems right down to spare parts. As an added feature comparison charts for monitors and printers are provided along with compatibility and upgrade information.

## Special Offer on Archimedes Computers

To coincide with the launch of our new catalogue Beebug are making some very special offers on new Archimedes systems.

### Archimedes A410/1 Free 1 Mb RAM & 42 Mbyte Hard Drive

The A410/1 is supplied with 1 Mb RAM. At no extra charge we will increase this to 2 Mb and install a 42 Mbyte high speed, top quality, branded IDE hard drive. Should you prefer an 89 Mbyte or 105 Mbyte instead, these are available for an additional £100 or £175 respectively.  
**Price £1099 With Colour Monitor £1319 (Acorn) or £1299 (CUBA3000)**

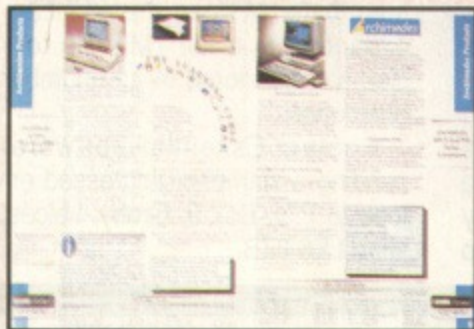

### Advanced Learning Curve Free 2 Mb RAM & 89 Mbyte Hard Drive

The A420/1 Learning Curve is normally supplied with 2 Mb RAM and a 20 Mbyte hard drive. We will increase the memory to the 4 Mb maximum and replace the 20 Mbyte drive with an 89 Mbyte high speed, top quality, branded IDE hard drive. Should you prefer 105 Mbyte instead of the 89 Mbyte, this is available for an additional £75.  
**Price £1299 With Colour Monitor £1519 (Acorn) or £1499 (CUBA3000)**



*These offers replace any previously published offers and are for a limited period only. All prices exclude VAT.*

**Hurry While Stocks Last.**  
Official Orders From Education Welcome

# BEEBUG

For your Free A4 Colour Product Guide  
please write or telephone:

117 Hatfield Road, St. Albans, Herts AL1 4JS  
TEL 0727 40303 FAX 0727 860263

## Library service takes up computing

AN experiment to popularise computing by the Library Services Department of Monklands District Council in Scotland has turned into a huge success.

The department opened the Whifflet Computer Centre at Coatbridge, Glasgow, stocked with a wide range of machines including a BBC Model B and Master. The centre also offers a number of software packages to its users.

"The total number of bookings for these machines over the last quarter, from May to June, was an astounding 3,314", said computer instructor at the centre James Aitchison. Special events there have included primary school visits for Basic instruction, formal classes covering all aspects of computing, individual instruction on application packages and an adventure games club.

The most recent event – the Hoppin' Mad Arcade Competition – was organised to coincide with the Monklands Festival. Two BBC Micros were used over a two week period with the popular arcade classic Hopper. The centre can be contacted on 0236 29118.

## Have a Dutch treat

THROUGH The Micro User, owners of Acorn machines in the UK have been invited to meet their counterparts in the Netherlands.

Big Ben Club, the Dutch Acorn Computer User Society, is to hold its ninth annual Open Day on Saturday, October 26.

It will be held at the Community Centre "De Kiekmuur", Tesselschadelaan 1, Harderwijk from 10am to 4.30pm. For further details ring Harry Linsen on 010 31 2526 72385.

## Not just a pretty face..

ALIEN, droid, male and female faces add another slant to ARcticulate, the new animated speech synthesiser from The Fourth Dimension (0742 700661).

They can talk to the computer user or converse with each other and for greater realism, the pitch, speed, volume and voice can be altered during and after any sentence.

ARcticulate works in the DeskTop, allowing full multi-tasking with wordprocessors and similar programs. It will read documents written by the user and also allows for jokes and questions to be inserted. Holding up to 600 words in any file and with an unlimited number of files, the dictionary is a Risc OS application.

Also included in the package are a selection of jokes, amusing noises, a provisional dictionary file and a demonstration program. An individual face and voice can be installed in less than 120k.

ARcticulate runs on both BBC A3000 and Archimedes machines. Price, £24.95.

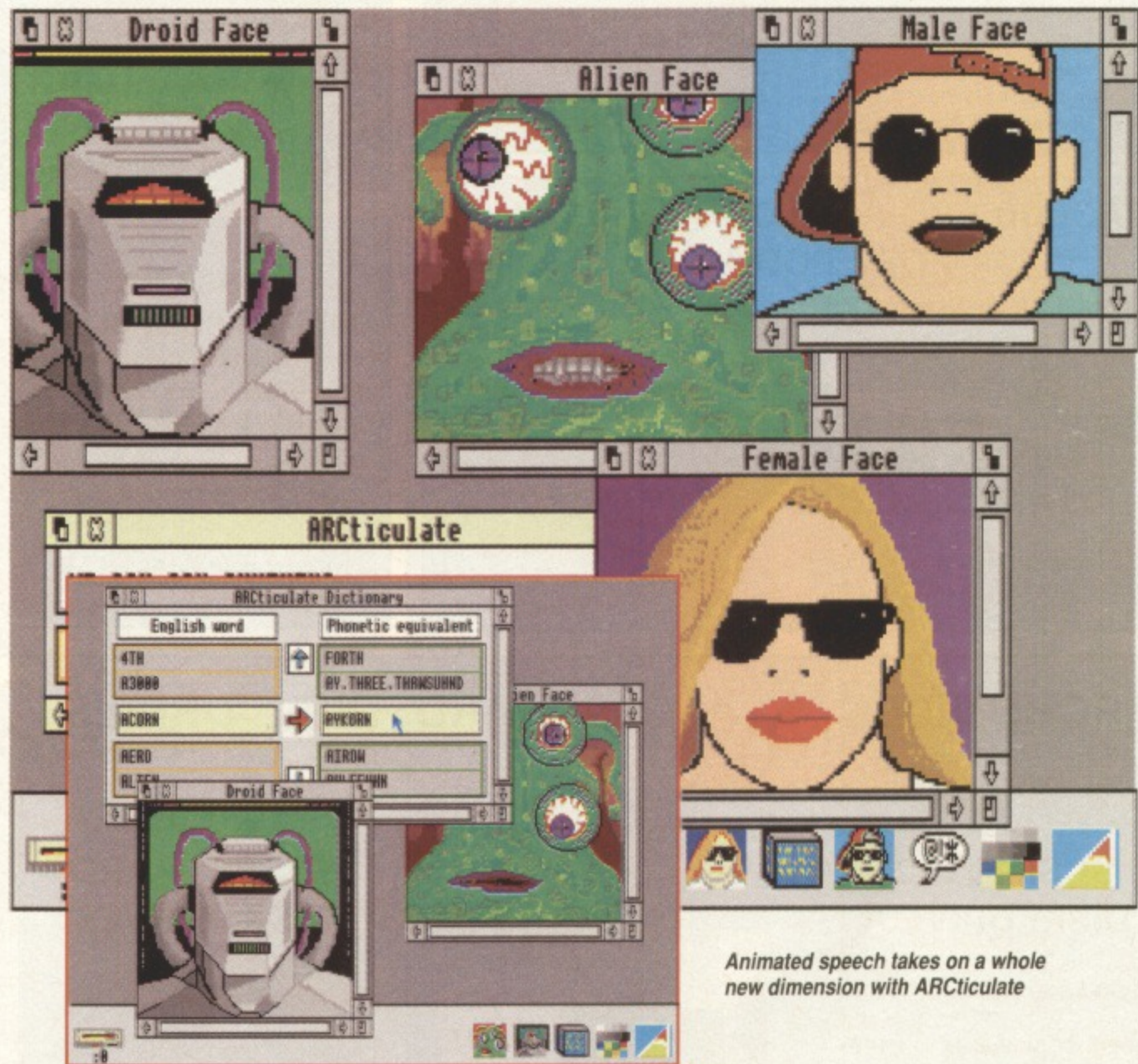

Animated speech takes on a whole new dimension with ARcticulate

## Network testing made easier

TRACKING down faults in an Econet network is generally perceived as a technical job but Alsystems (0420 87213) thinks differently. The company has announced the FLAT Box, a low-cost Econet test box which is ideal for non-technical people.

An acronym for First Line of Attack, FLAT Box features a "drop lead" tester to detect cable breaks and short circuits as well as crossed-over connec-

tions. Users simply plug in the DIN cable, rotate the selector to all five positions and observe the correct sequence of LEDs. Other features include multimeter sockets for one-handed operation when measuring cable resistances, LEDs to allow monitoring of both clock and data signals for faults, a terminator test facility and a Filestore internal clock test facility. FLAT Box costs £75 plus VAT and £2.35 postage and packing.

# MORLEY ELECT.



## SPECIAL OFFER

Phone for details of our latest special offers. We will try to match or better any advertised offer.



## THE WORLDS MOST POWERFUL MICRO

A3000	£599
410/1	£1099
420/1	£1299
440/1	£1699
The Learning Curve	£699
Arc. Learning Curve	£1299
A3000 Special Access	£679

## MEMORY EXPANSION

### THE BEST VALUE MEMORY UPGRADES

*Unlike most other cards, our expandable card can be upgraded from 1MB to 3MB at a later date for maximum flexibility.*

A3000 1MB Expandable	£69
A3000 1MB Non-Exp.	£59
A3000 3MB Upgrade	£179
A3000 1MB to 3MB	£140
305 1/2 MB	£69
400 Series 1MB	£50

## ARCHIMEDES PERIPHERALS

Acorn Colour Monitor	£199	Acorn ROM Podule	£56
Microvitec CUB3000	£189	300 2 Slot Backplane	£37
Mono Monitor	£73	300 4 Slot Backplane	£59
A3000 Monitor Stand	£20	300/400 I/O Podule	£85
A3000 User & Midi Port	£49	300/400 Midi Podule	£69
Serial Upgrade	£19	300/400 3.5" Drive	£115
Econet Upgrade	£49		

## LEADS & MISC. HARDWARE

Arch SCART Monitor Lead	£8	64k Printer Buffer	£115
Arch 9 Way Msync Lead	£8	256k Printer Buffer	£199
Arch Serial Lead	£8	EPROM Eraser	£18
Arch Printer Lead	£6	Eraser with Timer	£23
BBC Printer Lead	£6	5.25" Floppy Discs x10	£5
2 to 1 Printer switch	£20	3.5" Floppy Discs x10	£10
3 to 1 Printer switch	£30	27128 Blank EPROMs	£3
4 to 1 Printer switch	£36		

## A3000 BBC ANALOGUE & USER PORT PODULE

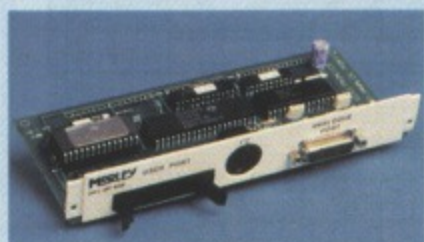

Full specification BBC analogue and user port. The analogue port is accessible using ADVAL from BASIC5 with all BBC OSbyte calls supported.

£59

*As Supplied to Acorn for their A3000 Special Access Package*

## CROSS-32

### META-ASSEMBLER

Table driven macro cross-assembler supporting over 30 processors with the facility to add more.

Phone for data sheet. £175

## ArcTools

Fully RISC OS compliant disc utility package. Various features including:

- Multiple file & directory manipulation (deleting, searching, setting access rights, file types etc.)
- System information (including computing index)
- File editor (both ASCII & hex)
- Disc Editor (both ASCII & hex)

£19

## ARCHIMEDES & A3000 HARD DISK DRIVES

*FREE ARCTOOLS WORTH £19 WITH EVERY HARD DISC DRIVE*

### SCSI HARD DISK DRIVES

#### INTERFACES

A3000 SCSI Podule	£149
400 SCSI Podule	£149

#### SCSI DISK DRIVES

Including SCSI podule, drive, cable & leads. A3000 drives also include drive case and switch mode power supply.

A3000 20MB	£399
A3000 48MB	£459
A3000 60MB	£559
400 20MB	£349
400 40MB	£409
400 60MB	£509
Larger Drives	POA



*Morley's SCSI and ST506 drives are among the fastest available. The podules are 16 bit and we only use fast, quality disk mechanisms. Phone for full details.*

### ST506 HARD DISK DRIVES

#### INTERFACES

A3000 ST506 Pod. Kit	£149
305/310 ST506 Podule	£149

#### ST506 DISK DRIVES

Including ST506 podule, drive, cable & leads. A3000 drives also include drive case and switch mode power supply.

A3000 20MB	£329
A3000 40MB	£399
A3000 55MB	£489
305/310 20MB	£299
305/310 40MB	£389
305/310 55MB	£474

## BBC / MASTER SCSI DRIVES



Completely compatible with BBC Bs, B+s and Masters fitted with ADFS. Free utility disc including Format, Verify, Archive and Park.

Interface only	£99
20MB incl. interface	£399
30MB incl. interface	£449
40MB incl. interface	£499



# R·O·N·I·C·S · L·T·D

## CONTROL ON THE A3000

### SPARKLE

Sparkle is a fully RISC OS compliant control package for the A3000 & Archimedes allowing full control of input, output and motor devices via most control boxes.

Sparkle is a simple language which gives users full access to control boxes as well as the ability to use analogue equipment and simulate inputs & outputs in a variety of ways. Data & frequency logging and counting & timing facilities are also provided as standard.

Sparkle £59  
Site Licence £200

### AnDi ODDULE

The AnDi Oddule is a low cost control box for the A3000 & Archimedes. There are 8 input/output connections, 4 analogue to digital inputs and 1 digital to analogue output. The box connects directly to an I<sup>2</sup>C connector (as on our Analogue & User Port interface) or can connect to a standard podule socket via an optional adaptor. The box can be controlled directly via RISC OS SWI calls or using Morley's Sparkle control software.

AnDi ODDULE £49  
Optional Adaptor £8

## ALFRED ROBOT ARM

The Alfred Robot Arm is designed to provide a low cost solution to the teaching of the principles of robotics in schools, colleges and industrial training departments.

The system is structured to provide on-going education by introducing expansion modules, therefore always updating the

system to meet new technology demands.

The complexity of exercises that can be carried out will benefit school children who are being introduced to robot technology or technical college students requiring an in-depth understanding of industrial robots. £330

## TELETEXT



### THE MORLEY TELETEXT ADAPTER

BBC/Master	£104
Compact	£120
RML Nimbus	£104
Archimedes	£125
Optional PSU	£9.50
Upgrade from BBC to Archimedes	£35

## BBC / MASTER EPROM PROGRAMMER



The fastest, best value programmer in the market.

Totally software controlled.

Programmes 27128/2764/  
27256 EPROMs: 12 and 21  
volt.

Includes full ROM  
management software with  
numerous features £40

EPROM utility disc. Put all  
your favourite routines into  
sideways ROM, both basic  
and machine code.

£7

## MASTER CARTRIDGES

Dual 2 x 16k	£10
Quad 4 x 16k	£14
Dual 2 x 32k	£12

### SMART CARTRIDGE

Built-in features include:  
-Freeze program at any point.  
-Screen dump (any mode).  
-Allows most protected  
software to be backed up  
including disc to tape and  
tape to disc. £40

## BBC / MASTER DISC DRIVES

Single 40/80 switchable £79  
Dual 40/80 switchable £169  
Power Supply £40

## A3000 ADDITIONAL DRIVES

### A3000 3.5" SECOND DRIVE



-Easy to install - simply plug in  
and run.  
-High quality Japanese drive.  
-Incl. full fitting kit (with one  
drive) and instructions £125

### A3000 5.25" SECOND DRIVE



Kit includes:  
-5.25" 40/80 track drive  
-Case  
-Power supply  
-Interface and leads £169

## A3000 DISC BUFFER

Supports up to three external drives  
Fully buffers all external drives  
Software control of step rate and double stepping of 5.25" drives  
Allows drive numbers to be changed from software £48

## MASTER ROM EXPANSION BOARD

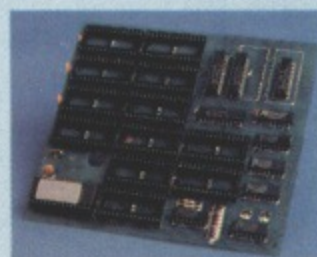

With 2 cartridges and a ROM  
board, a staggering 32 ROM  
images installed.

Allows an additional 8x16k  
and 4x32k ROMs to be  
installed in the Master  
and still leaves the cartridge  
slots free.

### THE ULTIMATE ADD- ON FOR ALL SERIOUS MASTER USERS

No more need to switch your  
computer off to insert a  
cartridge containing a required  
ROM.

Master control ROM which  
includes a clever file transfer  
program allowing files to be  
transferred between DFS and  
ADFS formats or vice-  
versa.

£49

*As well as manufacturing quality peripherals for  
over six years, Morley is an Acorn Dealer &  
Service Centre. This advertisement only covers a  
small range of the products we offer. If there is  
anything you want that you do not see  
advertised please phone for a competitive quote.*



## Power Pills

- Drop Ship
- Man-At-Arms
- Nevryon
- UIM
- Aviator
- Maze
- Winter Olympiad '88
- Castle Quest

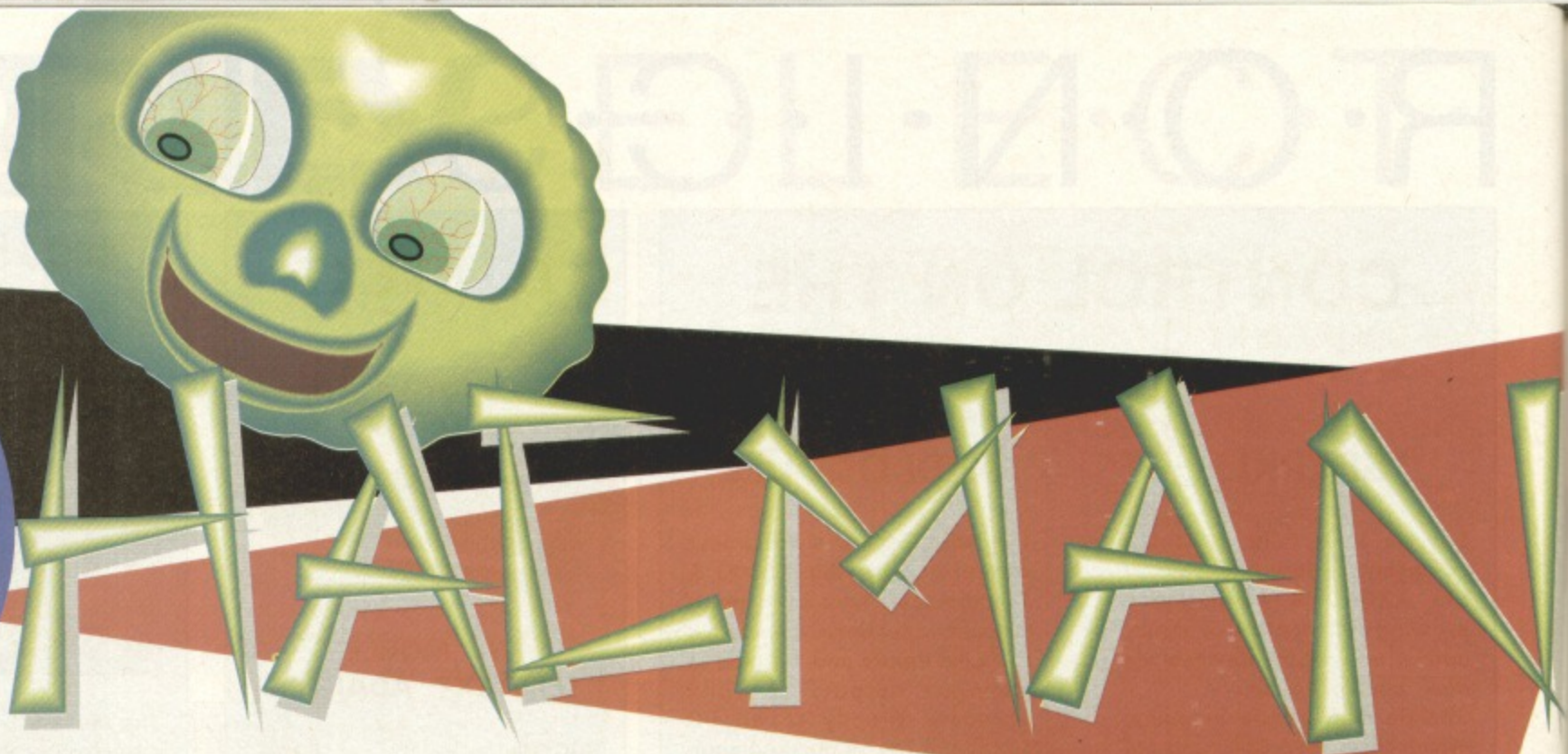

**W**ELCOME to another column, hopefully with a nice balance that should please everybody. So without further ado, play on! I have recently received the passwords for various Archimedes games, so here they all are.

The first are for **Drop Ship**, courtesy of David Ward of Rushden, Northants:

Stage A - No password  
 Stage D - DAHLIA  
 Stage G - GAGGLE  
 Stage J - KAUNDA  
 Stage M - NAUTCH

Note that these must be entered in upper case otherwise they aren't accepted.

For **Man-At-Arms**, courtesy of James Marshall and David Horner of

*Stuck, stymied, suicidal?*

*Hac Man offers his usual helping hand*

Tollerton, near Nottingham:

Level 1 - No password  
 Level 2 - INCUBUS  
 Level 3 - STRANGE  
 Level 4 - PULSARS

For **Nevryon**, courtesy of Michael Bannister of Filey, North Yorks and Matthew Taylor of Watnell, near Nottingham:

Level 1 - No password  
 Level 3 - MIRADOR  
 Level 5 - ISENGARD  
 Level 7 - KRYNN

Thank you one and all.

# Pass, friends

## Castle Quest clanger

Whoops! An eagle-eyed reader, Andrew Hawkesworth of Burnham, Berks, has spotted an error in one of my columns. The offending article is the infinite lives cheat for Castle Quest that appeared in the August 1990 column, specifically line 250. The printed

line read:

```
250 IF INKEY(-256)<None>
  &A2 PROCconvert
  should have been:
250 IF INKEY(-256)<>-1 A
  ND ?&ED0<>&A2 PROCconvert
```

Thanks to Andrew for putting this right.

```
10 REM >$.UIMcheat
20 REM Create a cheat file for
the Archimedes version of UIM.
40 MODE 3
50 OFF
60 HIMEM=&20000
70 PROCassemble
80 PROCsave_position
90 END
110 DEFPROCsave_position
120 PRINT "Insert game position
on disc"
130 PRINT "Press <SPACE> to save
Submariner CHEAT"
140 REPEAT
150 UNTIL INKEY-99
160 CLS
170 *DIR :0
180 OSCLI "SAVE $.Cheat 20000"
+400 "+STR$(endof)
190 PRINT "Complete."
200 ENDPROC
220 DEFPROCassemble
230 DIM MCODEX 256
240 dummy =RND(-28)
250 link =14
260 pc =15
280 M% =&8000 :REM Network memory
290 Q% =&3000 :REM Random value
300 U% =&80000000
320 FOR AX=0 TO 2 STEP 2
330 PX=&20000
340 [OPT AX
350 .money EQU 500 ;Ready cash
360 .fract EQU 80 ;Fractional
cash
370 .point EQU 80 ;Network Index
pointer
380 .magns EQU 81 ;Flares
390 .minut EQU 83 ;Torpedoes
held
400 .galax EQU 80 ;Network number
410 .plant EQU 230 ;Port number
420 .fuels EQU 1600 ;Fuel
430 .hydro EQU 80 ;Fractional
fuel
440 .treks EQU -1 ;Current mission
flag
450 .presy EQU 80 ;Process control
flag
460 .ships EQU 80 ;Ship status
470 .heats EQU 255 ;Heat shield
480 .smine EQU 81 ;Sea mines
held
490 .sixtn EQU 80 ;Workspace
500 EQU 80
510 EQU 80
520 EQU 80
530 EQU 80
540 EQU 80
550 ;Equipment =0 present ELSE
absent
560 .missl EQU -1 ;Torpedoes
570 .mines EQU -1 ;Mines
580 .pbeam EQU -1 ;Soxell generator
590 .phase EQU -1 ;Phase bomb
600 .flare EQU -1 ;Flares
610 .cloak EQU -1 ;Stealth device
620 .nbeam EQU -1 ;Chlorel generator
630 .empdv EQU -1 ;EMP unit
640 .tract EQU -1 ;Manipulator arm
650 .chaff EQU 80 ;Chaff
660 .xlase EQU -1 ;Hydrox generator
670 .chamn EQU -1 ;Chameleon unit
680 .glase EQU -1 ;Goledy generator
690 .therm EQU -1 ;Thermosystem device
700 .targe EQU -1 ;Re-target system
710 .headu EQU -1 ;Head up display
730 .juice EQU -1 ;Fuel
740 .cargo EQU -1 ;Cargo pod
750 .sheld EQU -1 ;Heat shield
760 .fconv EQU -1 ;Fuel converter
770 .eurek EQU -1 ;Central computer
780 .telep EQU -1 ;Teleporter
790 .navig EQU -1 ;Navigation module
800 .phexa EQU -1 ;Portfolio hexagon
810 .reentr EQU -1 ;Re-entry module
820 .missn EQU -1 ;Mission module
830 .finan EQU -1 ;Financial module
840 .drive EQU -1 ;Ocean drive
850 .deflt EQU -1 ;Deflectors
860 .gravi EQU -1 ;Graviton detector
870 .alock EQU -1 ;Air Lock
880 .mmodl EQU -1 ;Torpedo module
900 .melog EQU -1 ;Met. module
910 .btrap EQU -1 ;Booby trap detector
920 .neural EQU -1 ;Neural network link
930 .fcell EQU -1 ;Extra fuel cells
940 .tutor EQU -1 ;Subliminal tutor
950 .zener EQU -1 ;Zener
960 .ttape EQU -1 ;Ticker tape unit
970 .jubox EQU -1 ;Jukebox
980 .suicd EQU -1 ;Self destruct unit
990 .droid EQU -1 ;Maintenance droid
1000 .scoop EQU -1 ;Dust scoop
1010 .wethr EQU -1 ;Met. sensors
1020 .spech EQU -1 ;Universal translator
1030 .gunne EQU -1 ;Laser side arm
1040 .socio EQU -1 ;Sociological analyser
1050 .archv EQU -1 ;Network archive
1060 .strin EQU 80 ;Buffer for input string
1070 EQU 80
1080 EQU 80
1090 EQU 80
1110 .edent EQU 81 ;Equipment flags
1120 EQU 81 ;BIT 31=1 mass critical
1130 EQU 80 ;BIT 0=1 on display panel
1140 EQU U%
1160 EQU 81
1170 EQU U%
```



GAME

## Electron Mini Maze upgrade

The poke routines I have been providing for the disc versions of Electron games are proving popular. So here is another one that I wrote ages ago for a Plus-3 owning friend.

It is a mini-upgrade for Acornsoft's Maze, as provided on the Plus Three Games disc, and provides infinite ammo and the options of infinite or extra lives. Also, if you find that the action takes too long to hot up, you can select a higher start level.

As shown, the routine implements all pokes, so make any required alterations – such as deleting line 150 if you don't want infinite ammo, or editing line 60 if you want to start on a higher level –

before you type RUN. As with the Play It Again Sam poke routines, it must be saved on a separate disc.

Incidentally, one modification I made to my original BBC Model B was the addition of a switch that allowed me to bypass the machine's built-in speaker and redirect all computer sound through my hi-fi.

Although I did it so that the various pieces of music I had collected over the years would sound better, it certainly added an extra dimension to Maze. Imagine, if you will, the unnerving effect of running for your life when the room is filled with echoing footsteps growing ever louder. Great fun!

```

10 REM Maze upgrade
20 REM Plus Three Games disc
version
30 REM by Hac-Man 1988/1991
40 REM (C) The Micro User
50 REM
60 SX=1:REM start level (1-8)
70 LX=3:REM no. of lives (1-4
)
80 oscli=&FFF7
90 FOR IX=0 TO 2 STEP 2:PX=&9
00:COPT IX
100 JSR &A00
110 LDA# cont MOD 256-1 : STA
&1E25 : LDA# cont DIV 256 : STA
&1E26
120 LDA# &32 : JSR &1DB5
130 .cont LDA# &20 : STA &28B2
: LDA# &80 : STA &28B3
140 LDA# 3 : STA &28B4
150 LDA# &A9 : STA &3FFF : LDA
# 1 : STA &4000 : LDA# &EA : STA
&4001 : \ infinite lives
160 LDA# &EA : STA &40B4 : STA
&40B5 : STA &40B6 : \ infinite
ammo
170 JMP &4C5D
180 J:PX=&380:COPT IX
190 LDA# SX : STA &165 : LDA#
LX : STA &0605
200 LDA# 1 : STA &154 : LDA# 3
: JMP &2178
210 J:NEXT
220 PRINT"Please insert Plus T
hree Games disc and press any ke
y...";*FX 15,0
230 AX=GET:*MOUNT
240 !&A00=&09A272A9:!&A04=&F14
COAA0:!&A08=&1D0000FF
250 !&A0C=&0008FFFF:!&A10=&000
75000
260 CALL &900

```

```

10 REM Aviator Master convers
ion
20 REM for original Acornsoft
cassette version
30 REM by Hac-Man 1991
40 REM (C) The Micro User
50 REM
60 MODE 7
70 osbyte=&FFF4:oscli=&FFF7
80 FOR IX=0 TO 2 STEP 2:PX=&9
00:COPT IX
90 .start JSR &970
100 LDX# cli MOD 256 : LDY# cl
i DIV 256 : JSR oscli
110 LDA# &8C : LDX# 0 : LDY# 0
: JSR osbyte
120 LDX# &4E : LDA# 0 : STA &7
0 : STA &72
130 LDA# &11 : STA &71 : LDA#

```

```

&B : STA &73
140 LDY# 0 : .loop LDA (&70),Y
: STA (&72),Y : INY : BNE loop
150 INC &71 : INC &73 : DEX :
BNE loop
160 JMP &B90
170 .cli EQU "LOAD DASHBD"+CH
RS(13)
180 J:NEXT:*FX 15,0
190 MODE 7:PRINT "Please inser
t Aviator tape, and""press a ke
y...";
200 AX=GET:PRINT':*TAPE
210 *LOAD AVIATOR 2000
220 MODE 5:VDU 23,1,0;0;0;0;:P
RINT TAB(0,7);
230 PROCload:CALL &900
240 END
250 DEFPROCload

```

```

260 !&970=&208D99A9:!&974=&8D0
9A902
270 !&978=&0EA90221:!&97C=&8F42
004A2
280 !&980=&A08FA2FF:!&984=&8FFF
72009
290 !&988=&04A20DA9:!&98C=&84CF
FF44C
300 !&990=&2022222E:!&994=&8303
03131
310 !&998=&8A48080D:!&99C=&8AD4
89848
320 !&9A0=&FE2903CA:!&9A4=&68D0
3CA8D
330 !&9A8=&68AA68A8:!&9AC=&524
D6028
340 ENDPROC

```

## Aces high

I recently received a plea for help from a reader who said that he could not get his disc copy of Acornsoft's Aviator to load on his Master 128.

As I do not own a disc copy of Aviator I was unable to offer immediate assistance, but it did get me wondering whether or not the cassette version – of which I do own a copy – is Master-compatible.

I dug out my original cassette and tried it, and lo and behold, it wasn't: *Bad program* it reported stubbornly.

I disagreed with its prognosis, and here for the benefit of any frustrated would-be flying aces is a routine to convert the original cassette version of Aviator to run on the Master.

```

1180 EQU D &0
1190 EQU D &0
1210 EQU U X
1220 EQU &1
1230 EQU D &0
1240 EQU D &0
1260 EQU D &0
1270 EQU U X
1280 EQU U X
1290 EQU &1
1310 EQU &1
1320 EQU U X
1330 EQU &1
1340 EQU U X
1360 EQU &1
1370 EQU U X
1380 EQU &1
1390 EQU D &0
1410 EQU &1
1420 EQU &1
1430 EQU &1
1440 EQU U X
1460 EQU D &0
1470 EQU D &0
1480 EQU U X
1490 EQU &1
1510 .comod EQU D &0 ;Commodity
holding
1520 EQU D &0
1530 EQU D &0
1540 EQU D &0
1560 EQU D &0 ;Amount held
1570 EQU D &0
1580 EQU D &0
1590 EQU D &0
1610 .share EQU D &0 ;Share hold
ing
1620 EQU D &0
1630 EQU D &0
1640 EQU D &0
1660 EQU D &0 ;Amount held
1670 EQU D &0
1680 EQU D &0
1690 EQU D &0
1710 .filfi EQU D &0 ;Shares
1720 EQU D &0
1730 EQU D &0
1740 EQU D &0
1760 EQU D &0 ;Amount held integ
er
1770 EQU D &0
1780 EQU D &0
1790 EQU D &0
1810 EQU D &0 ;Amount held fract
ional
1820 EQU D &0
1830 EQU D &0
1840 EQU D &0
1860 .wraps EQU M X+RND(Q X) ;Ne
twork index values
1870 EQU M X+RND(Q X)
1880 EQU M X+RND(Q X)
1890 EQU M X+RND(Q X)
1900 EQU M X+RND(Q X)
1910 EQU M X+RND(Q X)
1920 EQU M X+RND(Q X)

```

## UIM Super Cheat

The name Matthew Atkinson will, I am sure, be well known to almost all players – he first sprang to prominence as the programmer of Superior's smash-hit Repton 3 series.

More recently he has been responsible for the Archimedes version of The Fourth Dimension's mega-blast, UIM. Although I do not think many players seriously expect to be expert submariners overnight, I have received a few letters from readers despairing of ever being able to get anywhere in this adventure.

Consequently, I am very pleased to offer the following routine, written by Matthew himself, which allows you almost limitless scope in cheating.

It does this by allowing you to customise a

saved file so that, when it is loaded in, your submarine is equipped exactly to your own specification.

To construct the most sophisticated vessel the oceans have ever seen, enter the following listing and save it on to one of your own blank discs.

Enter any modifications you want, then type RUN and follow the on-screen prompts. Now boot up UIM and load in your newly-created commander file, secure in the knowledge that you are almost invincible.

Matthew notes that you should not aim to give yourself too much equipment, as this may cause the program to crash. However, I'm sure most players can find their own level from all the additions on offer.

```

1930 EQU M X+RND(Q X)
1950 .cheat EQU D &0 ;Cheat loca
tion
1960 .endof
1970 MOV pc,Link ;Exit
1990 J:NEXT
2000 FOR AX=0 TO 2 STEP 2
2010 PX=MCODEX
2020 COPT AX
2030 .Encode
2040 MOV R0,#&0 ;Clear CRC
2050 MOV R1,#money ;Get address
base
2060 MOV R2,#&230 ;Loop counter
2070 .scan_list
2080 LDR R4,[R1],#&4 ;Load word
and move on four
2090 EOR R0,R0,R4
2100 MOV R3,#&20 ;Bit counter
2110 .thirty_two
2120 MOVS R5,R0,LSL#1
2130 EORCS R0,R0,#&1080
2140 ADC R0,R0,R0 ;CRC =*2+carr
2150 SUBS R3,R3,#&1
2160 BNE thirty_two
2170 SUBS R2,R2,#&4
2180 BNE scan_list
2190 STR R0,[R1] ;Store CRC in
cheat
2200 MOV pc,Link ;Exit
2220 J:NEXT
2230 CALL Encode
2240 ENDPROC

```

# UK's Largest Cash 'n' Carry & Mail Order Warehouse

# HIVOLTA

Now with  
New Customer  
Collection Service



## ARCHIMEDES

**FREE 1 YEAR'S  
ON-SITE MAINTENANCE  
with Archimedes Micros**

<b>A3000 COMPUTER</b>	<b>A3000 + LEARNING CURVE</b>
<b>£599</b>	<b>£699</b>

SYSTEM	ENTRY	MONO	COLOUR	MULTISCAN
410/1	£1099	£1159	£1278	£1448
420/1	£1299	£1359	£1478	£1648
440/1	£1699	£1759	£1878	£2048
540/1	£2995	£3065	£3178	—

### A3000 ACCESSORIES

3.5" External Drive	£97
Monitor Stand	£15
External Podule Case	£12
Serial Upgrade	£16
A3000 Technical Manual	£28
Dust Cover Micro/Monitor	£5
Dust Cover Micro	£9
User Port/Midi Upgrade	£44
UHF TV Modulator	£29

### ARCHIMEDES ACCESSORIES

NEW Multitasking RISC OS	£28
3.5" 800K 2nd Floppy Drive (305/310)	£109
5.25" 800K External Floppy Drive	£84
I/O Podule (Analogue & User Port & 1MHz Bus)	£75
MIDI add-on to I/O Podule	£27
MIDI Expansion Card	£64
Econet Network Board	£43
IEEE Interface Adaptor	£265
16 Bit Parallel I/O Card	£193
Software Developers Toolbox	£147
Floating Point Unit	£449
SCSI Adaptor Expansion Card	£159
Keyboard Extension Lead	£5
2 Podule Backplane	£24
4 Podule Backplane	£37

### HARD DISK DRIVES (ST506)

20Mb + Controller (310)	£294
40Mb + Controller (310)	£389
20Mb for 410 ST506	£159
40Mb for 410 ST506	£235
53Mb for 410 ST506	POA
A3000 20Mb + Podule	£335
A3000 40Mb + Podule	£449

### SCSI HARD DRIVES FOR A300/400

Supplied complete with controller card	
52Mb Internal	£348
105Mb Internal	£549
170Mb Internal	£829
210Mb Internal	£899

### FREE OFFER ON ARCHIMEDES MICRO'S

COMPUTER	FREE OFFER
A3000	Upgraded to 2mb RAM on Board + Monitor Stand + Dust Cover
A410/1	Upgraded to 2Mb RAM & a 20 Mb Hard Disc, (A420) + Dust Cover
A420/1	Upgraded to 4Mb RAM & a 40 Mb Hard Disc, (A440), Mk II Learning Curve + Acorn DTP Pack + Dust Cover
A440/1	High Resolution 14" Multiscan Colour Monitor + Dust Cover
or	Taxan 775 Monitor (Entry System) + Dust Cover
or	Star XB-2410 24 Pin Colour Printer (Colour System) + Dust Cover
A540/1	High Resolution 14" Multiscan Colour Monitor + Panasonic KX-P1180 Printer & Connecting cable
or	Taxan 795 or 775 Monitor (Entry System) or Star XB24-10 24 Pin Colour Printer (Colour System)

### BBC MASTER

MASTER 128K with View, Viewsheets, ADFS BASIC Editor & Terminal and our Special FREE OFFER. A 5.25" Double Sided, 40/80 Track switchable 400K Disc Drive and 50 Floppy Discs.	£399
---	------

### BBC B & MASTER ACCESSORIES

Turbo 65C102 Add-on-Module	£113
Econet Module for Master	£44
Twin ROM Cartridge for Master	£12
Master Reference Manual I (No VAT)	£13
Master Reference Manual II (No VAT)	£13
Master Advanced Ref. Manual (No VAT)	£16
64K Upgrade Kit for B +	£31
Acorn 1772 DFS Complete Kit	£47

### RAM UPGRADES FOR ARCHIMEDES

A3000	Upgrade to 2Mb RAM	£49
A3000	Upgrade to 4Mb RAM	£164
A305	Upgrade to 1Mb RAM	£48
A305/A310	Upgrade to 2Mb RAM	£229
A305/A310	Upgrade to 4Mb RAM	£419
A410/1	Upgrade to 2Mb RAM	£37
A410/1	Upgrade to 4Mb RAM	£99
A410/1	Upgrade to 8Mb RAM	£725
A420/1	Upgrade to 4Mb RAM	£72
A420/1	Upgrade to 8Mb RAM	£679
A440/1	Upgrade to 8Mb RAM	£569
R140	Upgrade to 8Mb RAM	£569

### MASTER 128 CUMANA DISK DRIVES

5.25" 200K Single 40T No PSU	£64
5.25" 200K Single 40T With PSU	£79
5.25" 400K Single 40/80 Switchable No PSU	£79
5.25" 400K Single 40/80 Switchable With PSU	£89
5.25" 400K Dual 40T No PSU	£125
5.25" 400K Dual 40T With PSU	£149
5.25" 800K Dual 40/80 Switchable No PSU	£159
5.25" 800K Dual 40/80 Switchable With PSU	£179
3.5" Single Drive No PSU	£64
3.5" Single Drive With PSU	£79
3.5" Dual Drive With PSU	£125
3.5" + 5.25" 40/80 Switchable	£169

## CONCEPT KEYBOARDS

A4 Standard Keyboard inc BBC Software	£115
A3 Standard Keyboard inc BBC Software	£140
A4 Archimedes Keyboard	£116
A3 Archimedes Keyboard	£141

## ARCHIMEDES SOFTWARE

### ART/DESIGN/GRAPHICS

Artisan II	£43
Atelier	£63
Autosketch II	£66
Gamma Plot	£38
Graph Box	£57
Mogul	£18
Poster	£77
Pro Artisan	£71
Render Bender 2	£56
Sigma Plot	£38

### DATABASES

AlphaBase	£34
Genesis	£64
Multistore	£192

### DESKTOP PUBLISHING

Acorn DeskTop Publisher	£125
Impression Junior	£77
Impression II	£131
Tempest	£93

### INTEGRATED

Desktop Office	£96
Logistix	£77
Pipedream 3	£118

### LANGUAGES

ANSI C Rel 3	£122
Assembler	£145
Fortran 77	£75
ISO-PASCAL	£75
LISP	£145
Prolog X	£145

### SILICON VISION

Arc PCB Professional	£269
Gerber Plot	£91
Realtime Solids Modeller	£132
Risc Basic	£72
Robo Logo	£52
Solid Cad	£115
Solid Render	£115
Solid Tools	£269
Super Dump	£19
Super Plot	£28

### SPREADSHEETS

Intersheet	£23
Schema	£90
Sigmashet	£38
Viewsheets	£44

### WORDPROCESSORS

1st Word Plus II	£68
Easiword	£29
Interword	£23
Protect 5	£129
View	£44

We also carry a wide range of GAMES and LEISURE software. Call for details.



# Triple Education

**Triple  Education** is a new company established to meet the ever-changing complex needs of YOUR child and the National Curriculum

## Behind Triple Education

### Pete Davidson (Project Director)

Pete has a BSc(hons) in Mathematics and Computer Science and also has certificate of education. He has been involved in education all his working life and has taught in Primary and Secondary schools and also lectured at University.

Over the past few years he has been involved in publishing magazines and software. He has been features editor of *The Micro User* and the world's first educational computer comic *Let's Compute!* He's also worked on many top educational software packages such as *Mini Office*, *Mini Office II*, and the award-winning *Fun School* series.

### Steve Botterill (Financial Director)

Steve is a well-known figure in the computer software industry. He helped to establish *Superior Software* as the leading games producer for the BBC and *Electron* from 1982 to 1988. More recently he set up *Impact Software* and now is co-director of *The Fourth Dimension* and *Triple R Education*.

Steve intends to bring to educational software the quality of sound and graphics that modern games display but are lacking from other packages. And with all the *Fourth Dimension* equipment and programmers to help, *Triple R* is going to set brand new standards for educational software.

## The REVOLUTIONARY Triple Overlays

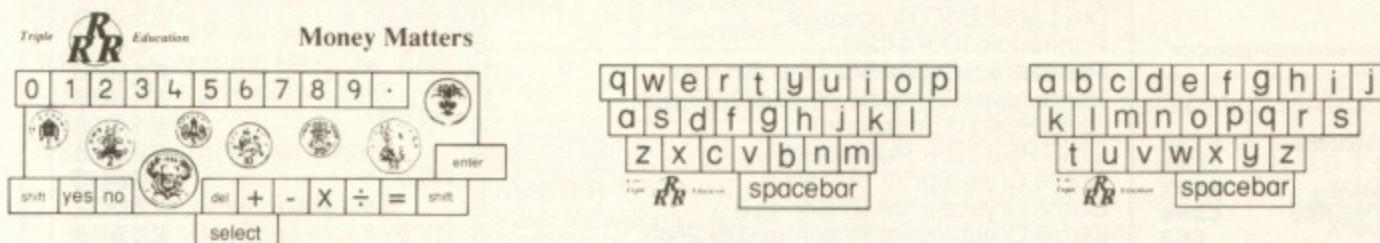

Children find the QWERTY arrangement and the capital letters of computer keyboards confusing. They're fine for typists, but far from ideal for use with educational software. So, to give YOUR computer a purpose-designed keyboard, *Triple R Education* has designed a UNIQUE series of overlays. They simply attach to your normal keyboard and can be quickly fitted and removed as necessary.

Your child need no longer be forced to use a keyboard designed for adult typists. He or she can now use one specially created with education in mind. They all have lowercase letters and are supplied in both alphabetic and qwerty order. There's even one showing coins to help children get to grips with money.

***These keyboard overlays are essential to help children to learn more from their computer!***

## AMAZING MAIL ORDER OFFER!

Buy any two of these innovative educational products  
and choose another **FREE.**

When you order, just let us know which three educational packages you want. You'll only be charged for the two most expensive.

**HURRY:** This offer ends on September 30<sup>th</sup> 1991

# Triple



# Education

## Picture Book

A fabulous friendly welcome to the computer world with a suite of four colourful programs. All use superb pictures and great sounds to keep children happy for hours as they learn:

- Alphabet Book:** An animated electronic version of a child's abc book.
- Spell it:** An enjoyable introduction to spelling.
- Count 'em:** Fun with numbers counting the pictures.
- Snap:** A bright and entertaining educational version of the popular game with three levels and for up to three players.

BBC/Electron tape.....12.95  
BBC 5 1/4" disc .....14.95

Master Compact 3 1/2" disc .....15.95  
BBC A3000/Archimedes disc .....19.95

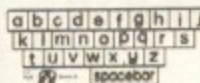

Picture Book comes complete with two revolutionary lower case keyboard overlays

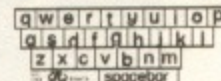

ARCHIMEDES

## Money Matters

A superb suite of programs to teach currency facts. Based on a circus theme it's ideal for all children from tots to teens. Youngsters will love the cheerful clown graphics and the unique coin keyboard overlay. **This is the best way for children to learn all about British coins and ways of tendering sums of money.**

For the more advanced child higher levels are designed with specific National Curriculum attainment targets in mind.

BBC/Electron tape.....12.95  
BBC 5 1/4" disc .....14.95

Master Compact 3 1/2" disc .....15.95  
BBC A3000/Archimedes disc .....19.95



Money Matters comes complete with a keyboard overlay. Children can press pictures of coins rather than the computer keys

ARCHIMEDES

## DataWord

This unique program has been designed with ease of use as a priority and fulfills many of the needs for a database in the National Curriculum. It works just like a card index but the flexibility of the text editor allows you to also use DataWord as a word processor too! Another really powerful feature of Dataword is the built-in card linking system which means parents and teachers can create files of inter-connected cards. **THIS IS NOT JUST A DATABASE,** it's a word processor, quiz game, electronic programmed learning book and a fabulous introduction to the world of Information Technology.

BBC/Electron tape.....12.95  
BBC 5 1/4" disc .....14.95

Master Compact 3 1/2" disc .....15.95  
BBC A3000/Archimedes disc .....19.95

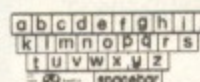

Data Word comes complete with two of the revolutionary lower case keyboard overlays and FIVE fascinating example files.

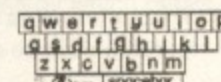

ARCHIMEDES

## Target Maths

Four cleverly designed educational games that make children want to come back for more. Each has been thought out with specific National Curriculum targets in mind.

- Eliminator:** Learn tables and progress from Novice to Expert.
- NumberFax:** A unique game showing factors, odd and triangular numbers and more.
- Scale Factor:** Read linear scales exactly - and at higher levels improve your arithmetic skills too.
- Slider:** A computer version of Snakes and Ladders.

BBC/Electron tape.....12.95  
BBC 5 1/4" disc .....14.95

Master Compact 3 1/2" disc .....15.95  
BBC A3000/Archimedes disc .....19.95

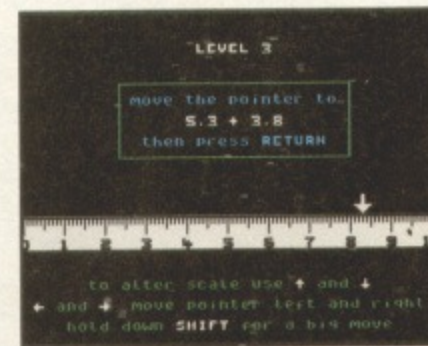
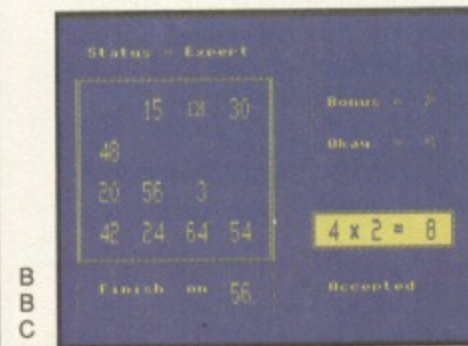

BBC

Target Maths comes complete with details of how each program meets the needs of the National Curriculum

ARCHIMEDES

## Converta-Key

Prices as above

Triple R alphabetic overlays are unique and our software is designed to work specifically with them. However we have now produced a program that lets you use the alphabetic overlay with any software that you write yourself. **It will also work with lots of currently available commercial software too!** Comes complete with a suite of introductory programs that you can use or customise to your own needs including: Hangman, Quizmaster, Anagrams, Memory Master, Find it and Speed-type.

Converta-Key comes complete with two of the revolutionary lower case keyboard overlays



**Send 'em in!!!**

If you have any ideas or have written any programs then please send them for evaluation. We pay top royalties and can offer the best technical support.

**SUPERFAST 1st Class FREE Delivery**

### LETTER

Simply send us a quick letter telling us the software you require, your name and address, and payment via cheque, postal order or ACCESS or VISA card details  
**Triple R Education, 1 Percy Street, Sheffield, S3 8AU, England.**

All orders are despatched immediately by 1st Class post. Carriage is paid by us in the U.K. (Overseas orders add £3 per product).

FULL DETAILS OF ALL OUR GAMES ARE AVAILABLE ON REQUEST & ARE SENT WITH ALL ORDERS.

### TELEPHONE

TELEPHONE ORDERS WELCOME  
**(0742) 700661 / 769950**  
ACCESS & VISA Accepted  
24 hour Service 7 Days a Week

**Triple R Education**

1 Percy Street  
Sheffield  
S3 8AU  
England  
Tel. (0742) 700661  
or 769950

# The Original *ideA*

"IDE is the small-computer drive standard for the future," said RISC User. "ST506 is on the way out; SCSI has only a limited future in the small drive market." Other manufacturers are now following our lead in IDE product development, but you know where the original *ideA* came from!

## PERFORMANCE

IDE is the only true 16-bit hard disc system currently available for Archimedes computers. All data transfers are 16-bit all the way from the disc, through the interface, to the computer (except that the A3000 internal interface has an 8-bit link to the computer).

## FLEXIBILITY

An *ideA* system can turn your A3000 into a 20, 40 or 60 Mb workstation with no external attachments, using hard discs which sleep quietly during periods of inactivity.

The *ideA* system caters for two low profile hard discs in the same internal or external housing, allowing you to build up your capacity in easy stages without wasting money.

Then there's the *ideA* 'hard card' option - a 2½-inch hard disc on a standard podule.

## VALUE

We think *ideA* upgrades offer the best value for your money, and we aim to keep it that way. Advanced IDE disc technology means simpler, cheaper, more reliable interfaces. Manufacturers' prices for hard discs fall gradually, and we pass these savings on to you as soon as we can.

Our upgrade prices include controller cards and fans where needed. Our disc cases are of metal construction.

## RELIABILITY

The first *ideA* customers have been using the system successfully since last year. The A3000 internal hard disc is particularly reliable - not one has had to be returned to us.

The latest IDE discs are ruggedly designed with lap-top and portable computers in mind. You'll wait a long time to see a defect! A skilled service team is ready to back up our guarantee should the need ever arise.

## COMPATIBILITY

The Micro User reported "no difficulty in running all fully RISC OS applications". Our IDE filing system is no different from ADFS in use, though it has a few extra features such as the facility to write-protect a hard disc. DOS partitions can be created for the PC Emulator.

## CONTINUED SUPPORT

The coming months will see the introduction of many new IDE products, including tape streamers and removable discs. You may rest assured that our software and hardware will keep pace with these developments. Updates for existing users, if they ever become necessary, will be simple and cheap.

*Only Ian Copestake Software has the expertise gained over a year in designing and supporting IDE products. Trust to our experience.*

**A beautiful solution.** (BBC Acorn User)

# QuicKey

Do you have trouble remembering what twelve function keys do, with and without Shift and Ctrl, in twenty different applications?

Do you enjoy watching PipeDream insert a column when you thought you were saving an Impression document?

Up to now the best way to organise function key strips was with one of our Arckey.

**From now on you may never look at a function key strip again.**

QuicKey shows 36 function key combinations on your screen. All at the same time, using the minimum of screen space, even in mode 12. You can choose any of these (plus Ctrl A, Ctrl B etc) using only the mouse.

**QuicKey knows which application is waiting for input and will show you the appropriate function key definitions - automatically!**

No more mis-directed key presses, because you can see what you're going to do before you do it. QuicKey costs only £10 + VAT and comes with a range of popular definitions (including Edit), to which you can easily add your own.

**You only have to lift your finger!**

**Some more original ideas!**

(Please see our main list for prices)



## TWO (Task and Window Organiser)

Do you wish you could start applications, display directories, and open files all in one go? With TWO you can.

Do you wish your pupils were able to start work without understanding the Desktop? With TWO they are.

Do you wish there was an easy way to tidy up your screen and find that buried window? With TWO there is.

TWO is far more than a 'sticky backdrop'. Its easy-to-use features make the Desktop a friendlier environment and will really save you time.

*"As a recent purchaser of TWO may I say how delighted I am with it. Life with 'Archie' has suddenly become much simpler!"*

*"Just received TWO - marvellous for time saving."*

*"TWO is the best thing I've ever bought!"*

# DrawBender

DrawBender distorts Draw files to follow a shape of your choice. A useful addition or inexpensive alternative to other graphics software, supplied with these **three** decorative fonts.

DrawBender is simple and enjoyable to use, with no complex menu structures. Yet it produces results of a superior quality using an iterative reparameterisation algorithm. The example above uses DrawBender with FontFX - the two make ideal companions.

*"An excellent tool. As though I've suddenly come across a new and unexplored area, very refreshing." "Quite stunning" (Archive)*

# AnDi Oddule

Baildon Electronics Oddules open the way to cheap, flexible and almost unlimited external expansion via the I<sup>2</sup>C bus already supported by RISC OS. Baildon are producing a range of Oddules which may be daisy-chained.

Ready now is the **AnDi** Oddule. It has eight digital I/O channels with high current open collector drivers, four A/D inputs, and one D/A output. AnDi is capable of emulating user and joystick ports, allowing ADVAL operation from BASIC, and the use of Concept Keyboards and analogue or digital joysticks.

## Cross-32 Meta-Assembler

This professional table-based cross-assembler works with over 50 target processors (including ARM2 and 3), and has been used for some time on PCs. A RISC OS Desktop version by Baildon Electronics is now available. Cross-32 is user-friendly and supports conditional assembly and macros. Output is in absolute binary, or Intel or Motorola Hex formats (ideal for eprom programmers and emulators).

You can modify the tables supplied or add new ones to cater for new processors and opcodes.

# Ian Copestake Software

TMU12, 10 Frost drive, WIRRAL, Merseyside, England, L614XL

Fax 051-632 3434 Tel 051-632 1234





## Directory updated

ACORN has produced a second edition of its Education Directory. Considered by many teachers to be the bible of educational IT, the directory lists more than 1,200 educational software titles specifically for the A3000 and Archimedes range of computers.

The latest edition has been updated with many new titles, giving detailed information on the programs themselves together with prices and also includes facts on the relevant software houses.

With 230 pages, the directory has 10 pages of titles listing and a 35 page section devoted to breaking products into categories both under educational subject and generic type.

"The first edition, with a print run of 10,000 copies and listing more than 1,000 titles, was so popular that we were sold out within less than five months", said Acorn's education business manager Chris Humphries.

"For this latest edition we have updated the database of available programs and, following useful feedback from our customers, we have made a number of improvements in the layout to make it even easier to use.

"With more than 130 maths-based programs, 70 modern language titles and over 70 different wordprocessing and desktop publishing programs out of the hundreds of listed titles - not

# Update

forgetting nearly 100 items of particular use for the Special Needs sector - it's not surprising that the Acorn Education Directory is in such high demand".

Available from Acorn dealers, the directory costs £4.95.

## Interactive application

SHERINGHAM High School in Norfolk, has become the first school to produce its own commercially viable interactive video system. Based on an Archimedes computer,

Project Shield is being marketed through Vu-Tel, a company formed by three teachers at the school

The first Shield database provides a wide range of tourist and local information on facilities and attractions in North Norfolk. A pilot system has been launched as a tourist information display at Norwich Thorpe railway station and a second is to be placed in Sheringham Tourist Information Centre

First shown as part of the Acorn display at the Multimedia Exhibition at Olympia, the system incorporates a simple touch pad which allows users to select the information they want on

particular attractions. This is presented in a combination of text, graphics, photographs, digitised images, sound and laservision.

The Archimedes is genlocked to a laser disc driver but can be run without the laservision if the video option is not required. Full screen outline maps have been produced as options to the text pages, making the attractions easy to locate. The system comes to life when the video option is triggered, giving 30 or 40 seconds of footage on a number of features

"The whole process by which pupils

## Impressive debut

NEW company Triple R Software (0742 700661) has announced a comprehensive series of educational programs for the BBC Micro and Archimedes.

DataWord is a database designed with ease of use in mind and positioned as a context-free piece of software. It works on the basis of a card index file. Users can write anything they want on the cards without worrying about the edit database structure common in most databases.

The flexibility of DataWord means that it can even be used as a simple wordprocessor and its built-in card linking system is a useful feature allowing parents and teachers to create files of cards for multiple-choice questions, programmed learning and much more.

DataWord features a browse mode - the first of its kind for the BBC Micro - and comes with two free keyboard overlays which convert the keyboard to lower case in either qwerty or

alphabetical order.

For younger children Triple R Software offers Picture Book, a suite of four colourful programs designed to introduce youngsters to the computer through animated pictures and interesting sounds.

They are Alphabet Book, an electronic, animated version of a child's first ABC book; Spell It where learning to spell becomes enjoyable; Number Fun where on-screen pictures are counted and Snap, a animated version of the popular game with four levels. Picture Book includes the free overlays.

Third in the Triple R line-up is Number Fun, a series of four games designed with specific National Curriculum targets in mind for children from eight to 14. Eliminator teaches tables on a sliding scale from novice to expert; NumberFax teaches factors, odd and triangular numbers and much more; Scale Factor teaches children to read linear scales and Slider is a computer version of Snakes and Ladders

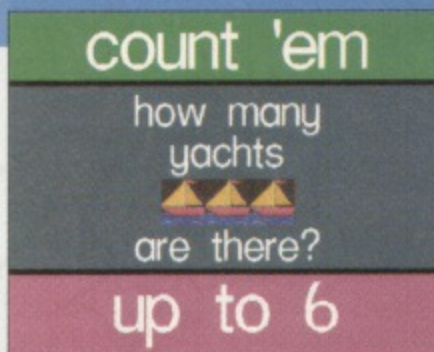

with 90 numbers on a series of random screens.

Also in the pipeline from Triple R is Money Matters, a suite of three programs to teach facts about currency. Coin It In teaches decimal coins and ways of tendering sums of money, with Gone Shopping, youngsters have to pay for their purchases and check the change and Work It Out is an on-screen calculator. Included free with Money Matters is a keyboard overlay with pictures of coins which are configured to correspond to the keyboard. Rounding off Triple R's launch plans is Converta Key, a useful utility allowing the alphabetic overlay to

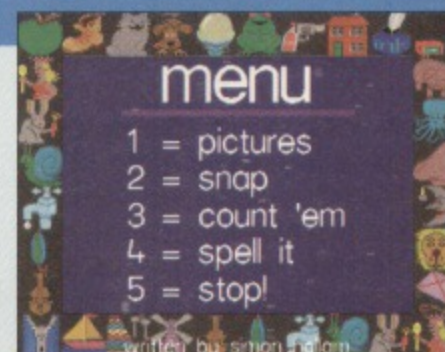

work with any software you write yourself. It will also work with a lot of existing commercial software.

Pricing for Triple R programs is £9.95 for tape; £12.95 for 5.25in disc and £14.95 for 3.5in disc.



and staff co-operate to plan, select, develop and synthesise the information in the production of the final database fulfills a wide range of National Curriculum requirements", said Roger Bird, IT co-ordinator at the school. "Once completed, the database can be used as a resource for pupil coursework in other GCSE areas".

Outside the educational aspects, it is intended to market the Vu-Tel interactive database as a package to schools, allowing them to set up units that can in turn become self-financing or even profit making. Vu-Tel can be contacted on 0263 860497.

### Key to information

A WIDE range of interesting new KEY educational products have been developed for ITV Schools by Anglia Television. Key Author presentation system is being launched on Archimedes machines and is seen as a major addition to the Key range. It is the core for developing a multimedia system which integrates fully with the database management system Key Plus

The first release of Key Author allows users to present text, graph-

ics, sound, video images, maps and Key Plus files in a way which allows them to follow a line of interest, investigate the details of a subject and view or listen to extracts from video disc or CD discs

The authoring package is fully Risc OS compliant and with an appropriate board, sound can be recorded from a microphone, played from tape or selected from CD or CD Rom disc. With the same genlock board as that used with Key Plus, laservision images can also be incorporated. Individual price of Key Author is £55 with site licences ranging from £65 to £180

Also due out shortly is Key Plus 2.0, the first major upgrade to Anglia's database management system. It features a fully integrated, worldwide mapping system, a range of selections plotting on the same map, quick language change facility, a single record selection, graph scaling control and the ability to handle Draw files

Schools with a Key Plus site licence get the upgrade automatically if they have taken on the technical support option. Those without the option or individual users pay an upgrade price £20. Site licences cost from £65 to £180

The range of Key datafiles has been upgraded for use with Key Plus. Those now available are the EarthData series, and others on his-

### Colourful files

THE aptly-named Chameleon from 4Mation allows colours in Archimedes draw files to be easily changed without the time-consuming editing task of ungrouping the complete drawing then putting it back together in the right order.

Using Chameleon, colours can be "borrowed" from another picture or selected from a number of different palettes. New colours can also be created using a sophisticated colour-mixing facility.

To change the fill colour of any object, the user just selects a colour and clicks on the object. Holding Shift at the same time will change the line colour, while holding Control allows objects with no fill colour to be filled. The drawing can be zoomed up to 16x magnification for detailed work. Chameleon

includes four different modes. Local affects only the object beneath the pointer; Global changes all objects using the same colour as the one selected; Within Rectangle allows a box to be placed over part of the drawing with only objects completely inside it affected, and Overlap Rectangle affects any objects which are only partly in the box.

An Undo facility remembers the last 1,000 colour changes and in addition to providing thousands of colours, Chameleon can convert a picture into 256 levels of grey and produce colour separations for professional printing. Price, £25.

4Mation are now at 14 Castle Park Road, Whiddon Valley, Barnstaple, Devon, EX32 8PA. Tel: 0271 25353, Fax: 0271 22974.

tory and natural history. They cost from £8.70 to £20

KeyNote, the primary school version of Key Plus is to be released for Archimedes and BBC A3000 machines. Individual cost £27.50, site licenses from £30 to £120

Built around the topic material needed in the classroom is a new range of clipart in Draw or Sprite files

which can be used independently of Key. They include African mammals, pond creatures, prehistoric animals and North American animals plus a number of historical files. Prices from £6.60 to £15

Launched to complement the worldwide mapping system in Key Plus 2.0 are a new series of map and gazetteer files costing from £5 to £20.

### Competitive chemistry

DESIGNED to complement practical GCSE work in the chemistry lab, Chemistry Super Star is a new BBC A3000/Archimedes release from Chalk Soft (0775 769518). It challenges pupils to use their knowledge and skills to solve a number of chemical puzzles and introduces a competitive boost with scores and a Hi-Score table.

The menu-driven program includes four games:

**Bottles** produces four reagent bottles which have lost their labels. You know the four reagents but must decide which is in which bottle by a series of tests.

**Reactivity** is a similar game with five metals – copper, iron, magnesium, silver and zinc. They have been mixed up and labelled A to E with solutions of their nitrates.

The test is to find out which is which from results of their reac-

tions with the solutions.

**Painter** challenges pupils to mix paint from pairs of solutions in such a way that they produce an insol-

uble precipitate which can be used.

**Network** uses the network of chemical compounds which must be moved across by going from

compound to compound using chemical reactions.

Chemistry Super Star costs £22 plus VAT and 75p carriage.

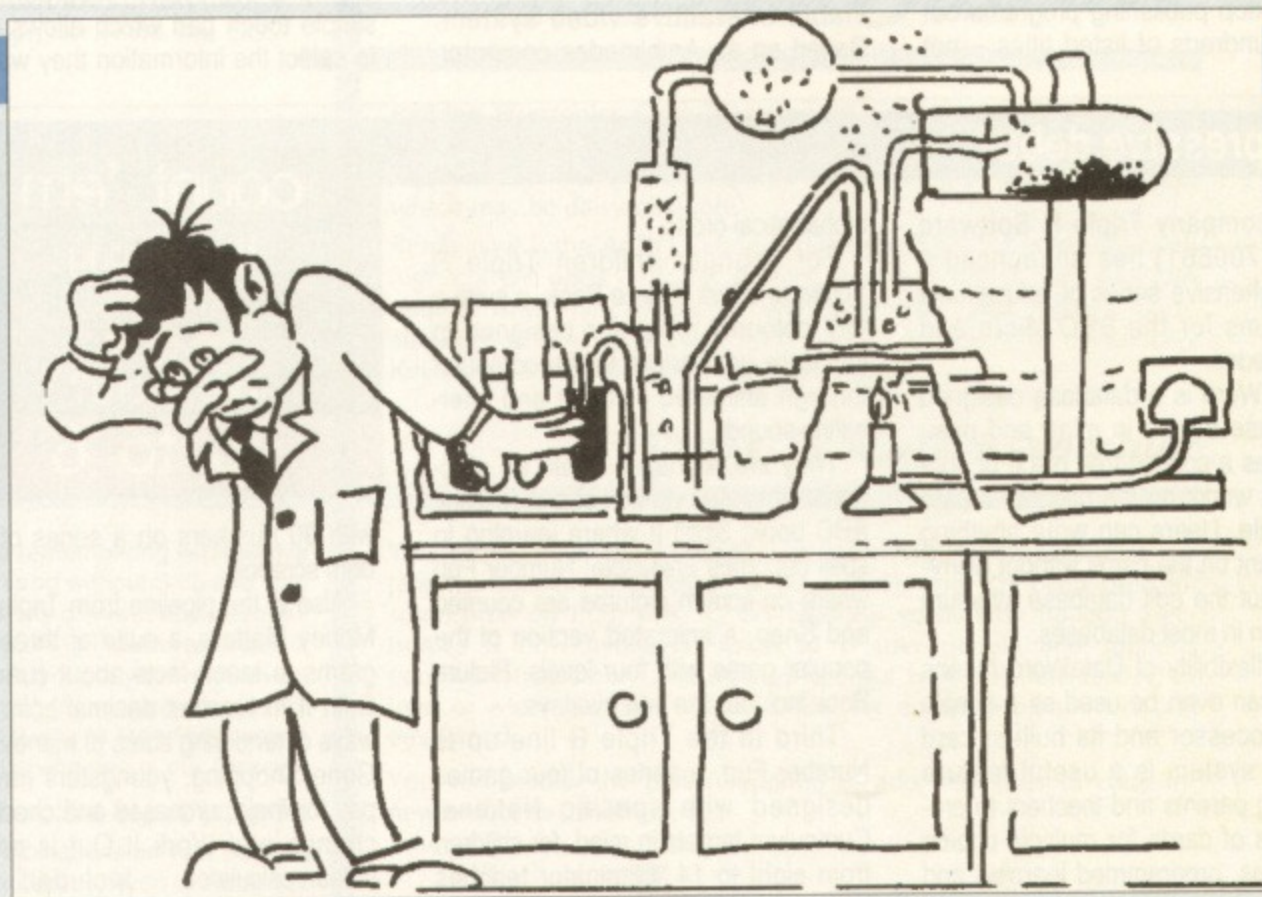

**W**HAT a splendid program this is. The graphics are excellent and the concept refreshingly original. This is an easy way of bringing the countryside to your classroom, rather than donning wellies and trudging through the mud.

In fact, it does what no school trip could do – it allows children to see wildlife at night. The discovery section of the package is controlled by the

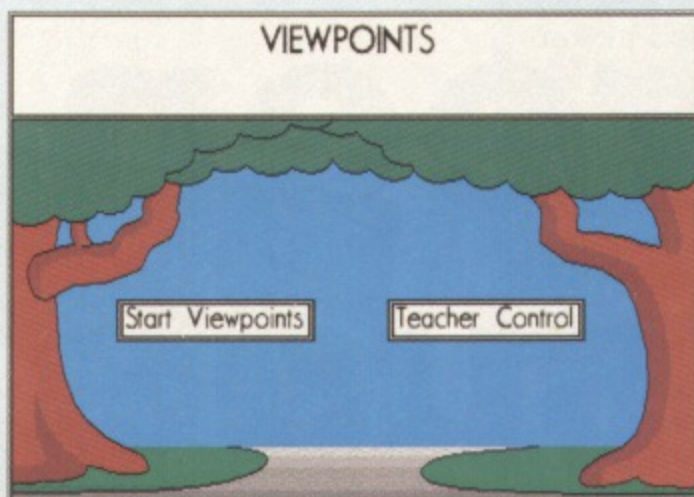

During the last few weeks a mining company have been testing the underlying rock for oil and gas. This has involved using explosives in many areas. Some of the animals have been disturbed by the loud noises and have moved away from their usual habitats.

OK!

Product: Viewpoints  
 Price: £35.00 + VAT  
 Supplier: Sherston Software,  
 SwanBarton, Sherston,  
 Malmesbury, Wiltshire SN16 0LH.  
 Tel: 0666 840433  
 Requirements: BBC A3000 and  
 Archimedes range

# Bird's-eye view of nature

*Shelley Birchenough hangs up her wellies and goes on a field trip with a difference*

mouse, always a great encouragement for slow or reluctant readers.

The main concept is that of exploration, rather like the traditional adventure game. The difference is that it all relies on graphical representation, rather than description.

It is also unusual to be able to see three different views at once, straight ahead is shown at the top of the screen with smaller left and right views lower down. This helps tremendously in deciding in which direction to go next.

With or without a map, children make their way around a large area encompassing town, garden, meadow, beach and rock pools, pond, mountains, river, sea cliff and oak wood looking for signs of wildlife.

Occasionally it is difficult to reach where you want to go, especially if you try to use general directions in relation to the map.

It really is essential to keep an eye on the screen views, as you tend to go further than you expect and change

direction when following a road or path.

There are lots of visual clues to keep you on the right track, although even an experienced orienteer who tried the program managed to get irrevocably lost.

Once in a general location, children have the opportunity to investigate. They have options to wait and see what appears, look at the area at night or look more closely at specific small areas which are then magnified for them.

The secret is to look everywhere for as long and as closely as possible. It is amazing how many different creatures appear.

Even after several hours at the keyboard, there were still lots of surprises in store. Some were easily recognisable, such as a fox, deer and a hedgehog, while others required a good knowledge of British wildlife or a handy reference book.

Some rare and endangered species have been included, such as the red

squirrel and the osprey. I must admit that it was unusual – to say the least – to find a puffin hiding in an oak tree in the wood.

The program also includes a treasure hunt, where children are invited to find a golden statue by following up clues which refer to locations on the map. This provides children the opportunity to use both problem solving and mapping skills.

Once a creature appears you can photograph it by grabbing the relevant area of screen which is then dragged to a data file.

As some of the animals and birds pass across the screen at a pretty fast pace, it takes considerable dexterity and fast reactions to snatch a good picture.

Up to eight pictures can be stored in the current memory – any more and they have to be transferred to a data disk under a file name of your choice.

The only problem here is that a new file needs to be opened each time pictures are transferred to the disc as they can't be added to an existing file. When this was tried, the original file was lost.

As it is possible to collect around 50 photos – a conservative guess, allowing no repetition of species – it would have been preferable to be able to save them all in the same file.

It is possible to use the database separately and it's one of the simplest

to use that I've seen. Printouts of files and pictures are very satisfactory and complement children's work well. There is a draw graph option which is both simple to use and very effective, all in all making for a very good, easily produced wall display.

The teacher's manual has been well written and is easily understood by computer specialist and non-specialist alike – it even has the luxury of an index.

Several pages are devoted to the relevance of the program to the National Curriculum, pointing out that it ranges from levels 2 to 6 in some subjects.

An excellent set of workcards comes with the package allowing more than ample follow up work, together with some very useful identification cards.

The map is provided in a range of sizes in both black and white or colour. There is obvious scope for a full term's work in this package.

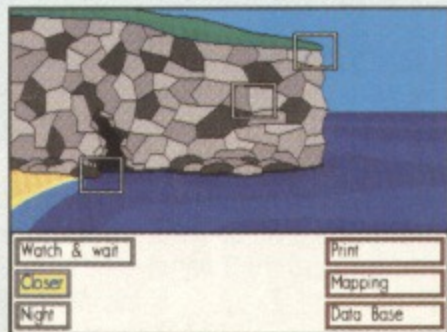

## Summing up

Viewpoints is lifted above the rest by the quality of the graphics and the originality of the idea. The support materials make it excellent for use in the classroom for children with limited or good knowledge of computers and/or the countryside.

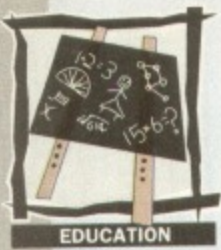

**W**HETHER you like using the programs or not – Key and Key Plus have certainly become among the most well-used of database handling programs, as they are available for the BBC series and also Research Machines micros, thus effectively having access to the vast majority of schools.

Although an acquired taste, Key does have excellent searching and sorting capabilities, and can easily produce a variety of graphic and statistical displays.

It has also been well supported, certainly within the primary age range, with very inexpensive datafiles which provide suitable information for manipulating and interrogating.

Many secondary schools will also opt for commercially produced files, such as these, especially when they are available at a comparatively modest cost. They have the advantage of being informed, relevant and presumably accurate, so that their use fits well within the National Curriculum framework.

These packages are part of a series available on Earth data and each comes with a glossy A4 size booklet, as well as the files on a DFS 5.25ins disc. The files can easily be transferred onto ADFS 3.5ins discs if required through the CopyData program on the Key program disc.

As with all Key products, the purchasing establishment may make a backup for use in the school – indeed it is highly recommended, for children have an uncanny knack of doing the unexpected.

The booklets are not actually designed to be used as such, for they are full – 28 or 32 pages – of Study Sheets which may be freely photocopied within the purchasing school.

Also included at the end of the booklet are a few worksheets – also designed to be photocopied – which

# Green Issues and IT

could provide some starting points for students using the files.

It is interesting to note that several of these do not necessarily require extensive access to the computer, concentrating instead on developing and encouraging systematic and logical approaches to research and study.

**Leaving the Planet** is of immediate relevance to most secondary school pupils, for many will have travelled in an aeroplane and most will accept their use and presence as routine. This series of files looks at man's attempts to travel further, faster and higher, seeking ultimately to escape from Earth's gravity.

These developments also affect our daily lives in many less obvious ways, such as the ability to receive live television pictures from all over the world, thanks to satellite technology.

Five datafiles are provided in the

*Product: Energy/Leaving the Planet/Our Neighbours in Space*  
*Price: £18.80 each*  
*Supplier: Anglia Television, Norwich NR1 3JG.*  
*Tel: 0603 615151*  
*Requirements: For use with Key/Key Plus*

*Phil Tayler*  
*journeys around the world*

pack, giving information about the various layers of the atmosphere, the developments in manned flight over the years, rocket development which has enabled the launching of spacecraft, satellite technology, and the history of manned spaceflight.

One criticism which could, of course, be levelled is that the data could become out of date at some fairly early point if the pace of progress continues to increase, but the files cover developments right up to the Space Shuttle missions.

It is also, of course, possible to amend the files should a watershed event occur within the next few years.

Various links exist with the national Curriculum Science document, with AT9 – Earth and Atmosphere, and AT16 – The Earth in Space the most obvious, although AT12 – Information

Technology and AT10 – Forces are also catered for.

The Study Sheets delve right back to the Middle Ages, with the ill-fated tower jumpers who strapped home made wings to their arms, and hurled themselves to their deaths. At the other end of the technological spectrum is some work concerning making a working model of the Space Shuttle.

Some extremely original and interesting information has been collected within these pages, and they make an excellent resource on their own.

It's the datafiles, however, that really develop the student's investigative powers, for example in researching a relationship between the length and width of various aircraft. This investigation could then lead on towards Design Technology as well, thus reinforcing the cross-curricular nature of IT.

**Our Neighbours in Space** continues the theme by looking more closely at the planets in our own solar system and the various probes with which we have sought to discover more about them.

There are also files about our nearest and the brightest stars. These contain information about constellations, distances from our solar system and graphics showing the locations of stars in their constellations.

The amount of data available from these six files is quite remarkable. The Solar System one, for instance, gives information about the nine planets which includes name, diameter, orbital radius, relative mass and density – compared with the Earth – rotational period, planetary year and axis inclination, as well as the surface temperature, relative gravity, escape velocity, atmospheric composition, number of satellites and albedo – the reflective quality of the surface of the planet.

Not all reference books would be able to give all this information as concisely, let alone in such an interactive way. This provides, therefore, another way in which this resource may be

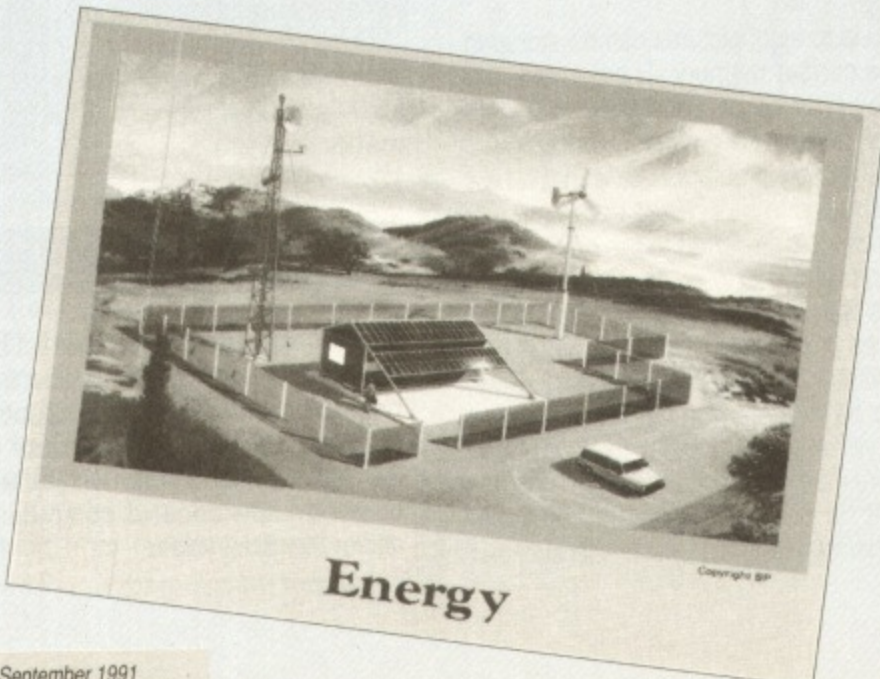

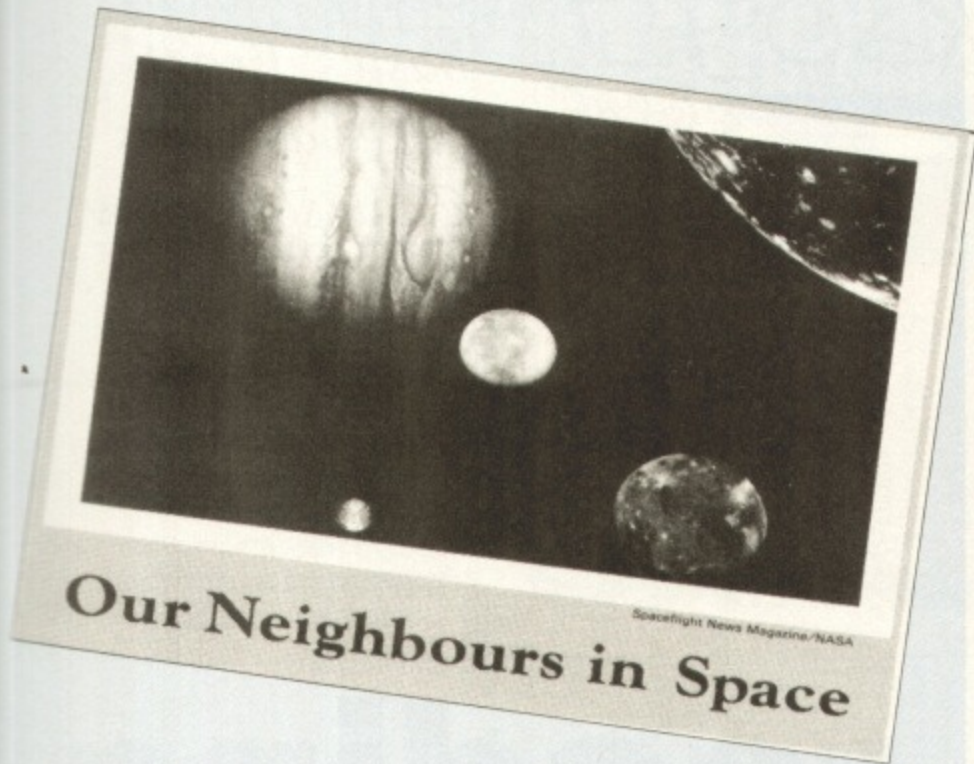

utilised – as an excellent resource for investigation in its own right.

And a study of, say, the relationship between the sidereal period and the orbital radius of the planets would be much more difficult to undertake without a computer, because data can be shown graphically, as a pie or bar chart, a scattergraph or a Venn diagram where appropriate.

There are also a comprehensive set of statistical options, including mean, median, standard deviation and Chi-squares.

The section within the booklet dealing with the Apollo and Voyager missions is one of the best parts, with exceptionally well written notes and a vocabulary which will be easily understood by the majority of users.

The booklet gives a great breadth of areas for investigation, including the lives of great astronomers, Black Holes and Supernovae.

**Energy** is a very complex subject, yet as the program notes remind us, there was not even a definitive word for it until fairly recent times.

It is also a particularly popular subject in schools, for not only does it have AT3 framed around it, but anything *green* now appeals immediately

to teenagers looking for a global cause.

The five files cover world energy statistics over the past 11 years, economic statistics for a wide range of colours, the energy values for a variety of fuels and oil prices across the years, compared with a 1989 dollar.

This last file gave, as one example, the amazing information that oil was more expensive in 1885 than in 1977. There is also set of data about the insulation qualities of various building materials.

This booklet, like the others, has black and white diagrams and plans for ease of photocopying, but every page has a good balance of text and graphics.

The subject matter on the Study Sheets ranges from theories about the origin of the universe, to the Severn barrage and energy insulation.

Many, such as those on solar and wind power, will provide stimulus for investigations in technology and science.

Like each of the booklets, there are also some *paper and pencil exercises* which positively require research away from the computer.

### Summing up

I'm sure that these files and booklets will prove invaluable in secondary school science departments, as well as perhaps in geography or history.

They are closely related to the Science National Curriculum document, and will remain so even after the latest juggling of Attainment Targets. It will also help to develop the kind of approach to work which students will need to have as they study for GCSE.

It's debatable whether the discs or booklets are the most useful part of the package, but without a doubt these packs represent a sound investment for schools currently using Key or Key Plus. Other titles in the EarthData series include Rocks and Minerals and Weather and Climate.

**Product:** Farmer Giles II  
**Price:** £20.40  
**Supplier:** Computer Tutorial Services, 17 Market Hill, Cowes, Isle of Wight PO31 7TR.  
**Tel:** 0983 294333  
**Requirements:** BBC A3000 and Archimedes range

**F**ARMER Giles II is a suite of four programs designed to help with the teaching of the first four levels of the National Curriculum's Mathematics Attainment Target 3 – Number.

The programs do this by using the farmer's flock of sheep to provide the child with addition, subtraction, multiplication and division problems.

The graphics are very good and the programs address the requirements of the National Curriculum. Level 1, for example, requires children to *add or subtract, using objects where the numbers involved are no greater than 10* and the program does just this.

Help is readily available and the program can be set for individual chil-

dren or a whole class.

The execution, however, needs more care. The sheep, for instance, appear to have been turbocharged. I am certain that no self-respecting farmer would entertain buying sheep that have been driven to market at Farmer Giles' speed.

The help option, selected by clicking menu on the mouse, is also spoilt, this time by a vocabulary inappropriate for the age of the children using the program.

The results section also suffers a similar fate. While comments about right or wrong answers pop up in a window which is much too small and which seems to be convenient for the programmer rather than useful to the teacher or child.

### Summing up

The program achieves its aims despite these problems, but I will be happy to include it in my collection only when an improved version 2 is available.

# Down on the farm

Frank Jukes reviews the changes

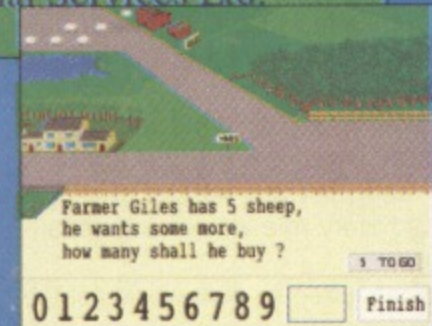
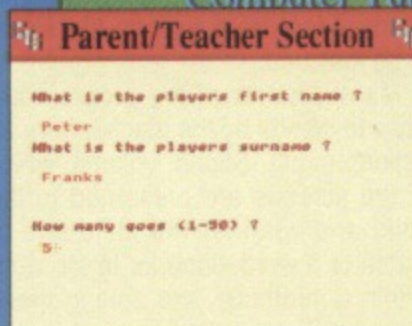
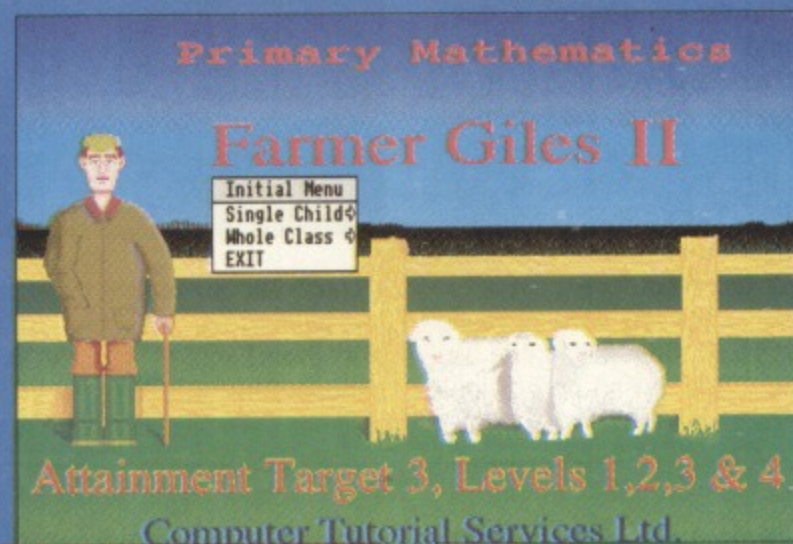



**C**HALKSOFT's experience and expertise show in their latest offering. First Words and Pictures is bright and cheerful and it provides lots of motivation for young learners.

The program is aimed at children aged from three to over seven years of age and at those with special educational needs. It provides opportunities for those in the early stages of reading to practise and extends their basic vocabulary by matching words with pictures.

There are 10 different screens, ranging in content from the kitchen to the farm and from the garden to the sea. Each contains eight items to provide a total of 80 varied words. Using

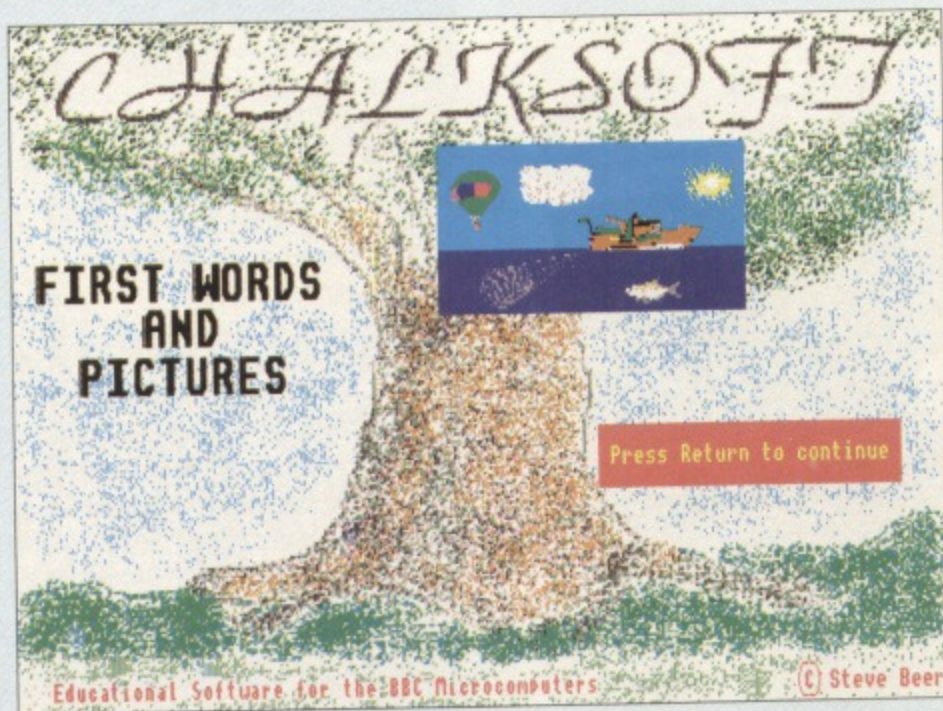

## Going back to basics, Frank Jukes assesses Chalksoft's new program

Product: First Words and Pictures  
Price: £25.85  
Supplier: Chalksoft, PO Box 49, Spalding, Lincolnshire PE11 1NZ.  
Tel: 0775 769518  
Requirement: BBC A3000 and Archimedes range

# Intuitive reading

the mouse or the keyboard the child matches words – alone or in sentences – with parts of the picture by clicking on the relevant object.

Arrows help to indicate possible choices, and success is rewarded by a magnified picture and a pleasant tune, while an incorrect choice is greeted with a noise described as a sneeze.

The inquisitive child will find that repeated clicking on the mouse while pointing at a wrong choice creates quite a cacophony of sound. Teachers beware.

Despite the sneeze, the program provides children with an unusually quiet and secure environment in which to explore and match. It does this through an excellent and varied choice of tune and colours.

Pictures are simple, but nevertheless interesting, offering plenty of opportunity for discussion and description. They, too, contribute to create a gentle and non-threatening working environment.

The program is very easy for young children to use. After seeing it in use just once – and having no previous experience of the Archimedes or of a mouse – a group of three five-year-olds read the word *rabbit* at the bottom of the screen and slid the mouse across the table top to point and click at the smiling rabbit in the picture above it.

From then on this particular teacher, hovering with lots of advice at the ready, felt very left out of things. My advisory role was clearly redundant.

When asked for their opinion of the

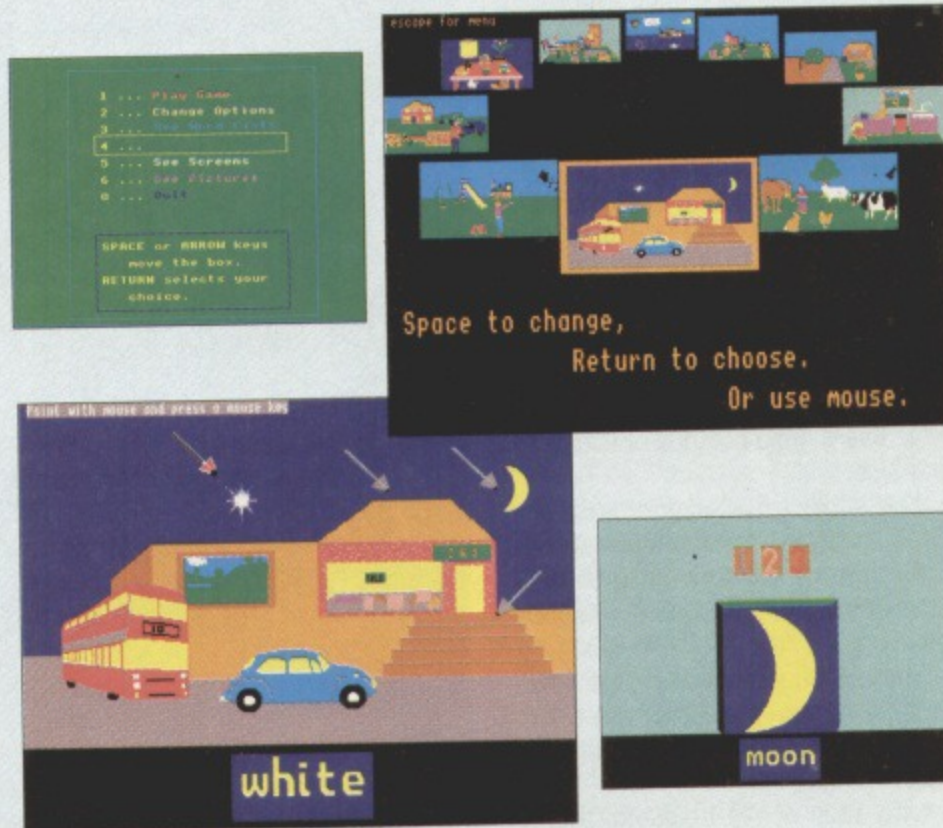

program and for a report on what they had been doing, the group explained that they had liked being able to choose their own pictures and that they had been enjoying themselves.

They had also liked the big letters at the bottom of the screen, a reference to the large, clear and pleasantly informal font used to form the words to be matched.

Many aspects of the program are open to control by the teacher from an options menu. Sound, volume, which of the screens are presented to the child and whether the child has to match to a word alone, or to the word within a sentence, are among these

and are easily changed using a simple menu and the arrow keys.

Options chosen in this way may apply for just the current session or may be made more permanent by saving them to the disc.

Word lists and sentences may all be inspected on screen and printed if required. Rather than sending a screen to the printer as a screen dump with what is often very muddy shading, First Words and Pictures prints a screen as a simple black and white outline which is eminently suitable for photocopying, colouring in or labelling.

These really are very clear and are

produced quickly by Control+P. Saving the screens to disc with Control+S from the appropriate menu allows them to be incorporated into DTP work.

All of this, along with the option to view them on screen, means that pictures can be discussed with the children without arrows or naming words – a very useful facility.

See Pictures allows you to see an enlarged version of each picture to be shown on screen for discussion. These may be printed or saved just like the usual screens.

Clearly, Chalksoft are committed to ensuring that schools are able to get full educational value from their software.

### Summing up

Looking to the future, I am sure that many teachers would find it useful to be able to use their own word lists and pictures – scanned in or created in Paint perhaps – for practice with a particular reading scheme or some other special grouping.

Teachers would agree that open-ended software is the most valuable kind, but this doesn't mean that programs such as First Words and Pictures have no place in the classroom.

I recommend the program to teachers wishing to see children practising some of the more common words which early readers come across or seeking screen-based pictures for discussion.

• No carriage charges on UK cash orders  
 • Up-to-date stock - no obsolete versions  
 • Credit cards not debited until orders fulfilled

ICS, Dept TMU13, 10 Frost Drive, WIRRAL, Merseyside, England, L61 4XL Fax: 051-632 3434 Tel: 051-632 1234

**VAT UK customers please add 17 1/2% to the total price, except for the zero-rated items marked 'v'. E.g. £100 x 1.175 = £117.50. VAT no. 364 3312 56.**

**Carriage Free in mainland UK if you pay on ordering.**

**Overseas** Add £6 (Europe) or £12 (elsewhere) for each software item if paying by pounds sterling bank draft payable in England, or Eurocheques not exceeding £100 each. If you are paying by credit card we will add airmail and insurance at cost. (Add £10 + 1% of the total price if you can only pay in your own currency).

**Credit cards** are welcome. The name and address for delivery of goods must be as known to the credit card company. If you are leaving an order on our answering machine include your telephone number (home will do), the expiry date of your card, and your calculation of the total payment due.

**Official orders** welcome. Payment due in 14 days. Invoices subject to carriage and late payment charges.

**Site licences** Please enquire if no price is shown.

All products, prices and specifications are offered in good faith and are subject to change without notice. Your order will receive our attention immediately, but suppliers sometimes keep us waiting.

Goods are guaranteed but we do not supply them on approval.

**BBC / MASTER / ELECTRON SOFTWARE**

- BET Basic Editor and Toolkit - rom module ICS £19
- rom in cartridge ICS £25
- Powerfont NTQ CC £13
- Spellmaster rom ICS £36
- Wordpower ICS £100
- site licence (extra) £7
- extra manual v0 £7

**ARCHIMEDES SOFTWARE**

If it's not on the list, please ask for a quote. We will always try to match the best prices.

- ABC Basic Compiler Oak £73
- Accounts Min £243
- ANSI C Release 3 Aco £124
- Apocalypse 4th £23
- Archway 2 Lon £50
- ArCComm 2 Sim £78
- ArCLight Ace £40
- ARC-PCB Sil £138
- Professional Sil £276
- Schematics Sil £475
- Armadae Cla £59

**RETAIL PRICE LIST August 1991**

Tel: 051-632 1234

- ABBREVIATIONS**
- Ace Acorn
  - Apr Apricot
  - Arm Armadillo
  - Arn Arnor
  - Arx Autodesk
  - Aut AutodesK
  - Bai Baildon Electronics
  - Bee Beebug
  - Cal Calligraph
  - Can Canon
  - CC Computer Concepts
  - Cha Chalksoft
  - Cir Circle
  - Cit Citizen
  - Cla Clares
  - ComT ComT
  - Dat Data
  - Eiz Eizo
  - Emr EMR
  - Gra Graphics Factory
  - Hum Human-Computer
  - Ico Icon Technology
  - ICS Ian Copestake
  - Ife IFEL
  - Iri Iriam Instruments
  - Kad Kador
  - Lin Longman Logotron
  - MicP Micro Power
  - MicS Micro Studio
  - Mid Midnight Graphics
  - Mit Colton
  - Min Computer Tutorial
  - Oak Data Store
  - Pil Oak
  - Ser David Pilling
  - Sil Serial Port
  - Sim Silicon Vision
  - Spa Spacetech
  - Sta Star
  - Sup Superior Software
  - Tec TechSoft
  - Wil Wild Vision
  - 4ma 4Mation
  - 4th Fourth Dimension
  - D Draw format
  - p Paint format

Font Pack 1 (Paladin, Swiss B, SymbolB, Vogue) Bee £43

- Font Pack CC £43
- Avant Garde / Bookman / Pembroke each £29
- Fortran 77 Release 2 Aco £79
- Fourier Analysis Arm £60
- Gammplot Min £52
- Gate Array Design/Teaching Sil £114
- GENESIS II v Oak £99
- GerberPlot Sil £92
- GraphBox Min £61
- Hard Disc Companion Bee £35
- Hearsay Bee £51
- History Costume P MicS £17
- Holed Out 4th £15
- Hostages Sup £15
- Hotlink Presenter Lin £42
- House of Numbers Cha £19
- Hyperbook Reader Lon £47
- Hyperbook Electronic Library (including Reader) Lon £109
- IMPRESSION 2.1 v CC £125
- network version £650
- site licence £545
- extra hardware key for sites £15
- extra manual for sites v0 £8
- IMPRESSION JUNIOR v CC £68
- site licence £435
- extra manual for sites v0 £7
- Inertia 4th £15
- Investigator 2 Cla £26
- Investigator 2 Ser £21
- Jiglet 4ma £26
- Jigsaw 4ma £27
- Keyboard Player Cha £17
- Knowledge Organiser Cla £46
- Landmarks Lon
- Egypt / Rain Forest / Second World War / Victorians each £18
- Letters and Pictures Cha £17
- LEVEL 4 FILESERVER v Aco £160
- Logo Lon £55
- Maggie Lon £48
- Maps and Landscapes 1 Cha £19
- Maps and Landscapes 2 Cha £19
- Mark Master Cha £67
- Master Break Sup £15
- Mogul Ace £17

- ArC Laser Cal £906
- Bubble Jet BJ-10e Can £276
- Sheet feeder £54
- Bubble Jet BJ-300 Can £399
- Bubble Jet BJ-330 Can £469
- Laser Direct Oume CC £856
- Laser Direct LBP-4 Card CC £323
- LASER DIRECT LBP-8 v £1280
- 8 ppm 600 dpi ind toner CC £1280
- LBP-4 4 ppm Can £750
- LC24-10 32k ram card Sta £61
- Swift 24 Colour Cit £225
- New Canon Toner cartridge £65
- Archimedes parallel printer cable £8
- ArCkey ICS v0 £3
- quantity of 4 v0 £10
- MEMORY, ARM3 ETC £24
- Real McCoy 2 4th £24
- Realtime Solids Modeller Sil £138
- Render Bender Cla £58
- Repton 3 Sup £15
- Revelation Lon £64
- Reversals Cha £17
- Rhapsody 2 Cla £45
- RiscBASIC Compiler Sil £112
- Riscforth Compiler Sil £112
- RISC OS Companion Vol 1 Oak £49
- RISC OS Programmer's Reference Manual Aco v0 £80
- RISC OS Style Guide Aco v0 £11
- RobotLogo Sil £75
- SCHEMA v Cla £91
- School Administrator Min £69
- Score PMS Emr £499
- ShareHolder Sil £139
- ShowPage CC £125
- Sigma Sheet Min £53
- Snippet 4ma £26
- SolidCAD Sil £109
- SolidsRender Sil £109
- SolidTools Sil £276
- Spark Pil £5
- Speech! Sup £15
- Spelling - week by week Cha £19
- Splice Ace £24
- Studio 24 Plus Emr £149
- Super-Dump Sil £24
- Superior Golf Sup £15
- Super-Plot Sil £30

**FUNCTION KEY STRIP ORGANISER**

- ArCkey ICS v0 £3
- quantity of 4 v0 £10
- MEMORY, ARM3 ETC £24
- Real McCoy 2 4th £24
- Realtime Solids Modeller Sil £138
- Render Bender Cla £58
- Repton 3 Sup £15
- Revelation Lon £64
- Reversals Cha £17
- Rhapsody 2 Cla £45
- RiscBASIC Compiler Sil £112
- Riscforth Compiler Sil £112
- RISC OS Companion Vol 1 Oak £49
- RISC OS Programmer's Reference Manual Aco v0 £80
- RISC OS Style Guide Aco v0 £11
- RobotLogo Sil £75
- SCHEMA v Cla £91
- School Administrator Min £69
- Score PMS Emr £499
- ShareHolder Sil £139
- ShowPage CC £125
- Sigma Sheet Min £53
- Snippet 4ma £26
- SolidCAD Sil £109
- SolidsRender Sil £109
- SolidTools Sil £276
- Spark Pil £5
- Speech! Sup £15
- Spelling - week by week Cha £19
- Splice Ace £24
- Studio 24 Plus Emr £149
- Super-Dump Sil £24
- Superior Golf Sup £15
- Super-Plot Sil £30

**PRINTERS**

- ArC Laser Cal £906
- Bubble Jet BJ-10e Can £276
- Sheet feeder £54
- Bubble Jet BJ-300 Can £399
- Bubble Jet BJ-330 Can £469
- Laser Direct Oume CC £856
- Laser Direct LBP-4 Card CC £323
- LASER DIRECT LBP-8 v £1280
- 8 ppm 600 dpi ind toner CC £1280
- LBP-4 4 ppm Can £750
- LC24-10 32k ram card Sta £61
- Swift 24 Colour Cit £225
- New Canon Toner cartridge £65
- Archimedes parallel printer cable £8

**MICE, MONITORS**

- Clares Micro Mouse Cla £26
- 90650S Eiz £450
- 9070S Eiz £640

**SCANNERS, DIGITISERS**

- ArcScanner including Epson GT-4000 Wil £1660
- Hawk V9 £330
- A3000 version £390
- Image (colour) Iri £589
- i-Scan 200 Iri £539
- i-Scan 400 Iri £589
- Scan-Light A4 CC £346
- Scan-Light Junior £432
- Scan-Light Junior CC £175
- A3000 version (internal) £175
- Scan-Light Junior 256 CC £210
- A3000 version (internal) £210

**INTERACTIVE MULTIMEDIA**

- Commodore CDTV ICCD 1000 £499
- including Encyclopaedia

**SUMMER BARGAINS!**

And even lower summer prices for Education - please enquire



**HARD DISC PRODUCTS**

The number at the end of a product name is the capacity in megabytes (rounded down). An L indicates a 1 inch high disc: two of these may be fitted in the same cradle or external case, sharing the same controller card. An S indicates a 2 1/2 inch wide disc mounted directly on the controller card.

**OUR PRICES FOR 'UPGRADES' INCLUDE THE IDEA CONTROLLER CARD, A FAN (where needed), AND EVERYTHING ELSE YOU WILL REQUIRE.** A backplane is optional with the A310 internal upgrade, but if you do use one it must be a four-layer type.

- COMPLETE UPGRADES**
- A300/400/500 internal upgrade £475
  - IDEARCIN20S ("hard card") £269
  - IDEARCIN40 £309
  - IDEARCIN40L £389
  - IDEARCIN80L £549
  - IDEARCIN120L £839
  - IDEARCIN200

- SEPARATES**
- Additional hard discs £219
  - IDEA40L 40Mb £309
  - IDEA120L 120Mb £459
  - A3000 accessories
  - IC PLINTH SPECIAL! v £18 (The best monitor stand)
  - idea controller cards and accessories

(For use with your own IDE hard discs; we can only accept responsibility for performance with discs we have tested ourselves)

- IDEARCIN Archimedes Intern £110
- IDEARCIN Archimedes Extern £140
- IDEA3EX A3000 External £140
- Internal hard disc cradle kit £15
- Fan kit (Standard) £10
- Case with power supply & fan £125
- Fan kit (A3000 Internal) £15
- Cable for second hard disc £5

Recommended for backing up Beebug Hard Disc Companion £35

Recommended for an easier life with the Desktop ICS Task & Window Organiser £19

Tel 051-632 1234

**All the above are available NOW!**

**KEYBOARD COVERS**

- Seal 'n Type (spill-proof) Kad £14
- Archimedes Kad £14
- A3000 Kad £14

**From our postbag**

I am writing to thank you for the faultless service I received when I purchased 4Mb and an idea hard disc. I was very reluctant to part with my computer fearing something was bound to go wrong and I would be left with no machine for weeks - I need it daily for my work as a headteacher.

However it all went like clockwork and my Archimedes seems an entirely different and more powerful machine, especially using Impression.

**ICS FONTS**

- 1st Word Plus First Fonts PipeDream PipeDrivers Wordpower Power Fonts

Please ask for details of our range of Symbol Sets and Typefaces for most printers. For example:

- Star.LC.10.typefaces
- Black, Caldy, Outline, Pensby, Raby, Shadow, Universal
- PipeDriver.Dot.1

For dot matrix printers with more features than PipeDream knows what to do with - provides access to resident and download fonts, ink colours, variable print size and line spacing etc

**ODDULES**

- AnDi Bai £49
- Oddule Adaptor Bai £8
- (needed with your first Oddule unless you have an iPC socket)

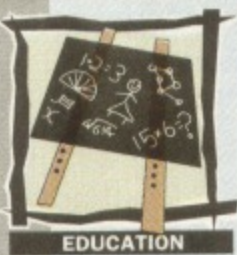

Product: *Computers and Learning – Helping Children Acquire Thinking Skills*, by Jean and Geoffrey Underwood  
 Price: £8.95  
 Supplier: Blackwell Scientific Publications, Osney Mead, Oxford  
 Tel: 0865 240201  
 Product: *Computers and Literacy Skills*  
 Price: £6.95  
 Supplier: British Dyslexia Association, Dept of Psychology, University of Hull, Hull

**C**OMPUTERS and Learning – Helping Children Acquire Thinking Skills, is the kind of book that we have needed for a long time. There have been several successful advice books over the years dealing with the specific and practical problems of using computers in the classroom, but this goes one step further.

The first thing that strikes you is that this is not the sort of work you can pick up the night before it's your turn to have the computer. The approach is more remote and academic but this is what we need.

The Underwoods have stepped back from the classroom to look at the broader picture – where we've been, are and might be going.

They start with an exploration of the issues involved with the use of computers in education. The refreshing thing about this – and the rest of the book – is that both sides of the argument are explored. Though you are not left in doubt as to the authors' feelings, you don't feel a heretic if you disagree.

Moving on to examine the way children's minds can be extended, we can see the computer firmly linked with current educational theory. This is the kind of thing teachers tend to lose track of

when tied up with practical issues such as finding an electrical socket which works. Logo features prominently, and this section raises – though doesn't answer – a lot of questions about the fragmentary effect the National Curriculum has had on the use of computers in schools.

Posing the question *Why put IT into schools*, the book's answer is concerned directly with IT in its pure and content-free form – the machine is seen not as a device for teaching but for learning.

The following chapters examine CAL from this perspective, looking at the uses of databases and word processors. The word processing chapter in particular disassembles the processes involved and examines exactly what is going on at the machine and within the child.

It goes on to look at the way the computer can stimulate social interaction with comments on the effect of gender within the group. Some of the points made will probably make you look differently at the use of the machine and the way you organise it.

There is a very useful section on the evaluation of software as well as on the evaluation of its effect on the children.

**Computers and Literary Skills**, from the British Dyslexia Association, is a collection of papers from some of the most respected and, more important, qualified movers in the field of computers and reading difficulties.

There is no discernible thread running through the 18 pieces except to start with A Rational for Computer Assisted Literacy Instruction and finish with an overview of support structures past, present and future.

Many of the chapters have a wider range than simply dealing with the dyslexic child or adult. Any teacher or interested parent will find views and ideas about the educational uses of word processors, adventure games, spelling checkers and so on.

It is also interesting to see the way many programs which mainstream edu-

# Helping Hands

*Marshal Anderson explores two new books to facilitate the introduction of computers into the classroom*

cationalists would dismiss as drill and practice, are both useful and effective within this area of special needs.

More specific pieces deal with the use of portable computers with dyslexic students and software for phonics development. It has to be said though that some of the writers have had little contact with the chalkface, as there is scant regard for the investment of time these systems demand of the teacher. However, someone has to do the original research and come up with the ideas that teachers can then bring down from the clouds into the real world!

Where there are specific practical examples of applications in the classrooms these are well documented with believable examples and specific software, looking for instance at the use of Logo for children with reading difficulties.

Of even more practical use are the extensive appendices of addresses and contacts for software and advice. There is also a extremely sensible system put forward for the evaluation of software in education generally, as well as specifically for reading difficulties.

What I found rather disappointing is

the way the book is aimed at experts in reading problems who know little about computers.

There is a comprehensive glossary of computer terms, but the needs of the reader who is still unclear on what dyslexia actually is are largely ignored. There is no glossary of educational/psychological terms used.

## Summing up

The Underwood book is very academic in approach and style which makes it rather heavy reading. The conclusion that computers are a force for fundamental change in education may not sit easily with the ordinary class teacher's experience. However, the book will confirm or challenge what you are doing in the classroom.

The British Dyslexia Association's book is interesting with at least as much to say to the ordinary citizen as to the reading specialist, but non-specialists should be prepared to do a little background work before tackling it

# From Victorian to Green values

*Marshal Anderson assess the latest support documents from Longman*

Product: *Landmarks – The Victorians, Rain Forest*  
 Price: £19.95 + VAT  
 Supplier: Longman Logotron, Dales Brewery, Gwydir Street, Cambridge CB1 2LJ.  
 Tel: 0223 323656  
 Requirements: A3000 and Archimedes range

**L**ONGMAN Logotron and the BBC have recently added to their Landmarks, all the programs being linked to the BBC TV schools series of the same name. As Longman Logotron have recently taken over the BBC educational software side we can expect more of this kind of publication.

An off-shoot of this to please schools

is that they have adopted the BBC's pricing policy, so you can expect the high technical quality of Longman software linked to the very reasonable prices teachers have come to expect from the BBC. Unfortunately this is only to be reflected in the TV-linked software.

The Victorians is based in Oakey in the west of England in 1886. Following the familiar pattern Landmarks is multi-tasking and sits on the icon bar.

Clicking on the icon opens the text and graphics windows. The former is used for a fairly standard adventure for-

mat input through which the children communicate with the program.

The graphics window contains a black and white scanned photo which changes occasionally depending on where you are and what you want to see. Like the previous packages, the quality of picture is very disappointing most of the time and so their use is limited.

We are talking to Ernest, a 10-year-old boy just recovering from scarlet fever. The characterisation is really nice with Ernest speaking pure memmerset





## ARCHIMEDES A3000 PRODUCTS

**Monitor stand (A3K1)** – Probably the best monitor plinth available for the A3000 and the basis of a modular system.....£24.95

**System housing (A3K2)** – When you are ready to expand the A3000 this system housing is added, allowing up to 2 floppy drives and a hard drive to be added. ....£69.50

**Expansion card case (A3K3)** – If you are adding an expansion card ("podule") to an A3000, such as a hard disc card, then you will need this podule case to connect & protect the card.....£14.95

**Disc buffer (A3K6)** – If an extra floppy drive/s is to be connected then you will require a disc buffer. This one supports up to 3 additional drives and incorporates software control for physical to logical drive mapping and 40/80 stepping which could prove essential when using discs in 65 Host or PC emulator. A key feature is the built in expansion for further cards to be added internally; also see A3K12. *NB: Some cheaper products may only provide connection for an additional drive without buffering*.....£48.95

**20Mb hard disc (A3K7)** – A 20Mb hard disc drive ready to fit in A3K2, including the hard disc card and all cabling. We are not aware of any other hard disc upgrade that is treated as an internal upgrade (consult your Acorn dealer or call PRES for details).....£399.00

**NEW 40Mb hard disc (A3K14)** – As A3K7 but twice the capacity .....£499

**3 1/2" Additional floppy drive (A3K8)** – 3 1/2" disc drive and mounting brackets for A3K2.....£75

**5 1/4" Additional floppy drive (A3K9)** – 5 1/4" disc drive and mounting brackets for A3K2 – ideally suited for 65 Host or using the PC emulator.....£99.95

**65 Host 1770 DFS & DFS Filer (A3K12)** – A ROM and disc upgrade for A3K6 provides: 1. A desktop DFS filer that allows DFS files to be dragged to ADFS viewers or straight into applications as Edit or Pipedream. 2. BBC 1770 DFS for use in 65 Host. Automatic Icon and loader which can allow BBC DFS discs to have <SHIFT BREAK> operation. "...effectively turns your A3000 into a Model B"... *Acorn User, Sept. '90*.....£19.95

All prices exc. VAT

# PRES

Tel: 0276 72046  
Fax: 0276 51427

IN THE FOREFRONT OF A3000 UPGRADES

PLEASE  
CALL FOR  
DETAILS OF  
PACKAGE  
PRICES



"PRES's range of add-ons offers tremendous advantages. The system can grow with your pocket, it offers security and strength but most importantly it offers choice." (AU Feb. 90)

The starting point is the monitor plinth, probably (we feel definitely) the best on the market @ only £24.95 (plus VAT), from there... System Housing, Hard Disc Upgrade, Additional 3 1/2" Disc Drive, Additional 5 1/4" Disc Drive, Podule Case, Dedicated A3000 Disc Buffer, 1770 DFS for BBC Emulator & DFS Filer for Desktop, plus more to come! (the last three products can be added independently of the other items)

Contact your local dealer or call PRES direct on 0276 72046 for advice on upgrading your A3000. We have built our reputation on honest dealing on quality products with thousands of satisfied customers.

WE STILL PRODUCE AND SUPPLY OUR RANGE OF "8 BIT" PRODUCTS FOR THE ELECTRON, BBC B AND MASTER. IF YOU WANT TO KNOW MORE ABOUT UPGRADING WITH ACORN COMPATIBLE PRODUCTS... CALL FOR DETAILS

### SPECIAL PRICE

DUE TO A REMARKABLE PURCHASE WE CAN OFFER OUR ARCHIMEDES HARD DISC UPGRADES FOR...

**£100.00 LESS**

THAN OUR NORMAL ADVERTISED PRICES  
20 & 40 MB DRIVE UNITS COMPLETE WITH THE TRIED & TESTED ST506 (ACORN) EXPANSION CARD. COMPLETE WITH ALL NECESSARY CABLING & INSTRUCTIONS FOR SYSTEM FITTING. SUBJECT TO AVAILABILITY

A400 series users solve your storage & backup problems by fitting a second hard disc to your machine. The S.P.A.C.E. KIT allows you to fit another hard drive (behind the existing one) as a simple upgrade for: £32.95 (exc. VAT). Complete upgrades including either a 20MB or 40MB hard drive available. Both drives are supplied formatted, soak tested & verified ready for use from £249 (exc. VAT)

EDUCATION AND DEALER ENQUIRIES WELCOME

## STOP PRESS

FOR THE MANY CUSTOMERS WHO SAY THEY WOULD PREFER TO DEAL WITH US DIRECT... WE NOW OFFER A 'ONE STOP' SOURCE FOR YOUR ACORN REQUIREMENTS. THIS INCLUDES COMPLETE A3000 SYSTEMS, A400 SERIES AND LEARNING CURVE PACKAGES.

## NEW PRODUCTS

THE S.P.A.C.E. KIT... FIT A SECOND HARD DISC TO YOUR A400 COMPUTER. THE MISSING LINK (TML)... FAST DATA TRANSMISSION BETWEEN ARCS. FLOPPY LOCK... DISABLES AN ARCHIMEDES DRIVE BY LOCK & KEY.

## COMING SOON

TRUE PODULE EXPANSION FOR A3000

P.R.E.S. Ltd, Box 319, Lightwater, Surrey GU18 5PW

Tel: 0276 72046. Fax: 0276 51427

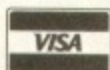



EDUCATION

with a nice line in double negatives. Capable of impatience, boredom, excitement and curiosity, he is certainly three dimensional enough for children.

The village has a single employer, the mill, which is run by the Hodgkinsons. They live in the Big House, but we're not allowed in there though we can go into the yard.

Having established this, Ernest got agitated about the fact that he had to get some homework from his school. Discovering that he does "drill" in the playground, we move into the classroom with its rows of seats. Ernest sits at the back to avoid Mr Owen and his cane.

Ernest's main problem is Eli Forester who pulls faces and gets him into trouble. Indeed this is one of the nice things about this series – the way the children find common ground across the years.

Another point of interest is the village shop where Mrs Tucker sells all sorts of things – as long as you have money. Investigating the parser at this point I was rather disappointed with its performance.

Let's assume for a moment that we hadn't had our trip to the school, a logical question to ask a 10-year-old is: **Do you go to school?** But Ernest replies: *Who cares? What shall us do now?*

A child with some experience of parsers may persevere to input: **What is your school like?** The response to this is: *I don't know.* OK, let's try again: **Describe school.** Finally Ernest replies: *'Tis wondrous in here! There's all anyone could want for sale here...* and he goes on with a description of the shop.

Having discovered that the parser is linked to the place I tried something not connected with a specific place: **Have you any brothers and sisters?** *I've got three brothers and three sisters.*

Great, we're getting somewhere. **What are their names?** elicits the response, *I'm not interested in my family – let's do summat else.*

Intrigued, I continued: **Why aren't you interested in your family?** *Don't know.* So I tried: **Tell me about your**

parents. *'Tis wondrous in here ...*

It's a problem which seems to pervade the whole series rather than a bug. Though not badly written, it's simply the state of artificial intelligence at present.

Perhaps the problem is that the software tries to cover too large an area. There have to be set responses to inputs that have no specific replies programmed in.

The usual response is *I don't understand*, and it's easy to see why the author wanted to avoid that. To get round that he uses the technique developed in the days of the Elisa project which gave a random, non-committal response to unexpected inputs. But the replies in Landmarks are not non-committal enough and so can be misleading.

Rejoining Ernest we are ready for another jaunt, this time to the cave. Before we can go we have to visit Ernest's house for matches and a candle.

A mine of details, the house provides the atmosphere the program portrays so well. Comments abound such as: *We're not allowed in the parlour, except on Sundays.* The boys sleep four to a bed, and there's a sewerage system that should make modern children's hair stand on end.

Exploring the main areas of the cave and hearing the legend of the witch is brilliant and the language used to describe the cave gives a real feel for the place while still sounding like Ernest.

A wealth of information is to be had from this program, which will keep the children busy for hours. From a National Curriculum viewpoint it fits snugly into key stage two.

It is also directly relevant to the core study unit three, especially the domestic life side. But it also helps with other Attainment Targets such as: *Recognise that over time some things have changed and others have stayed the same and Describe different features of an historical period.*

Rain Forest is different from the rest of the series in as much as it is not historically based but geographic. We are in Brazil with our guide, Betumi, who we

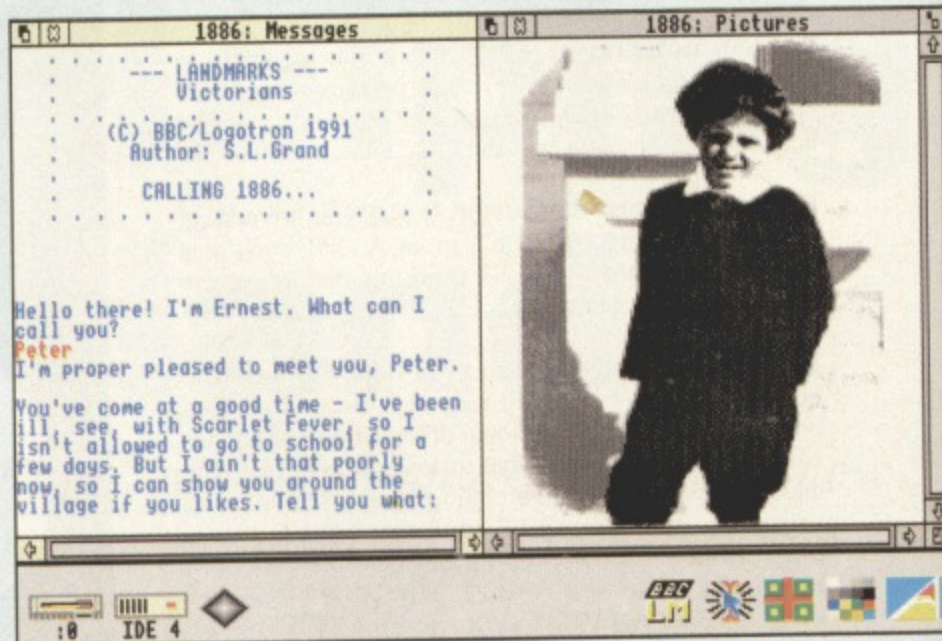

can assume is about the same age as Ernest.

She lives in the rain forest which is a place full of activity with toucans and monkeys in the trees and plenty of thick undergrowth for us to plough through.

Her fellow villagers from Caractatumi are also around and they all live in a shabono – a circle of huts in a forest clearing. She lives there too with her two mothers, father and brother.

Wandering and exploring with Betumi we find a village garden with a wealth of detail on the crops grown and information on how such a garden is created. This raises a lot of issues on how the resources are used and the way land can be exhausted by some agricultural processes. On the cultural side we meet the village shapori or witch doctor. He is presently casting out evil spirits from the new garden and exhorting the land to bring forth a good harvest.

The most exciting part of the program is to get Betumi out on the river in a canoe. This takes us down stream and over rapids with a sequence of vivid description.

Ending up at the site of an old village which is used as a signpost, this gives us an inkling of the dangers of getting lost alone when Betumi find her way back to the village.

The space available for exploring seems a lot smaller than in earlier programs but there is plenty to discover. The workbooks direct children to the areas needing exploration and many Geography Attainment Targets are covered in an interesting and imaginative way.

Both programs help children explore environments otherwise unavailable to them. Yet I do have reservations. The parser is one and the time-out feature another. This causes the program to stop if the children don't type for a given amount of time.

This can be very irritating as you have to re-load the program from the disc to start again. Having said that, when you do re-start you are at the

place you exited.

Unfortunately, time-out gives rise to another problem. At first glance the fact that Landmarks is multi-tasking is very useful as on a 1Mb machine there is enough room to have Pendown or !Edit running alongside to allow children to make notes.

However, time-out continues to run while you are in another application, so if you go off to write something the chances are that Landmarks will have stopped while you were away.

The documentation is full of suggestions on how to use the packages and all come with really useful pupils books than can provide some direction within such an unstructured activity.

As they stand, the Landmarks programs are an interesting exploration of a new area in educational software. They present the child with an environment to explore in a free and open ended way.

The graphics so far have been disappointing and the way the machines handles the language needs a lot of work. However, Landmarks are an important step along a developmental track that should lead to even more innovative and exciting software.

It takes time, and it seems churlish to suggest that a package should not be used simply because it has not yet reached its full potential



## Summing up

If you are using the TV programs over the next year all the packages are a worthwhile investment. And if you are covering any of the four areas in some other way the specific packages will add an extra dimension to the children's work.

From the point of home use, the Victorians and World War Two are both substantial enough to be worth adding to your child's collection.

# COLOURJET 132

## COLOUR INK JET PRINTER

### Compatible with:-

IBM pc  
Archimedes  
Nimbus  
BBC Micro  
Amiga  
Apple Mac  
(serial version)

LOW COST  
LIST PRICE  
from £636 + VAT



Low  
Operating  
Cost

Windows 3  
Driver  
available



EMULATES OTHER COLOUR PRINTERS EG. IBM 3852, Canon PJ1080A, Quadjet  
PRINTS OVERHEAD TRANSPARENCIES

EDUCATIONAL DISCOUNTS AVAILABLE

**INTEGREX LTD.**, CHURCH GRESLEY, SWADLINCOTE,  
DERBY'S DE11 9PT

Tel (0283) 551551

Fax (0283) 550325

T/y 341727 INTEGY







**W**E looked last month at using our I<sup>2</sup>C interface to act as a transistor curve tracer, so now I thought we would use it to investigate the action of a capacitor.

Now we did design a capacitor charge curve plotter way back in November 1983. However, as we were only using the single ended input of the Model B's A/D converter all we could show was the voltage across the capacitor in response to a voltage step.

By using the differential input capacity of the I<sup>2</sup>C interface we can measure the current through the capacitor as well as the applied and capacitor voltage.

Not only that, but using the analogue output capacity of the board we can also investigate the effect of a capacitor on different waveforms.

Figure I shows the basic arrangement of a series resistor and capacitor. If we apply a voltage *V* the capacitor will start to charge up.

As charge accumulates on the capacitor plates the voltage across them increases. This reduces the voltage across the resistor, so the current through the circuit drops.

The capacitor charges up exponentially, that is to say the voltage across the capacitor never actually reaches the charging voltage but continually gets closer to it.

The actual expression for the voltage across the capacitor *V<sub>c</sub>* at any time *t* is:

$$V_c = V (1 - e^{-(t/CR)})$$

where *V* is the charging voltage and *e* is the exponential function and *t* the time. *R* and *C* being the values of resistance and capacitance.

If you examine this formula with a calculator you will find that when *t/CR* is three you are practically at the charging voltage, in fact just over 95 per cent.

The value of *CR* is known as the *time constant*, this means that when you have been charging a capacitor for three time constants you will have over 95% of the charging voltage across the capacitor.

As far as the voltage waveform is concerned it is fairly easy to visualise an exponentially increasing voltage. However, what about the current waveform? Also what about when anything other than a voltage step is involved?

Well, we could thrash through the maths and come up with transfer functions, but to most people that would not get over the feel of what is happening.

What we want to do is to actually apply voltage waveforms to a capacitor

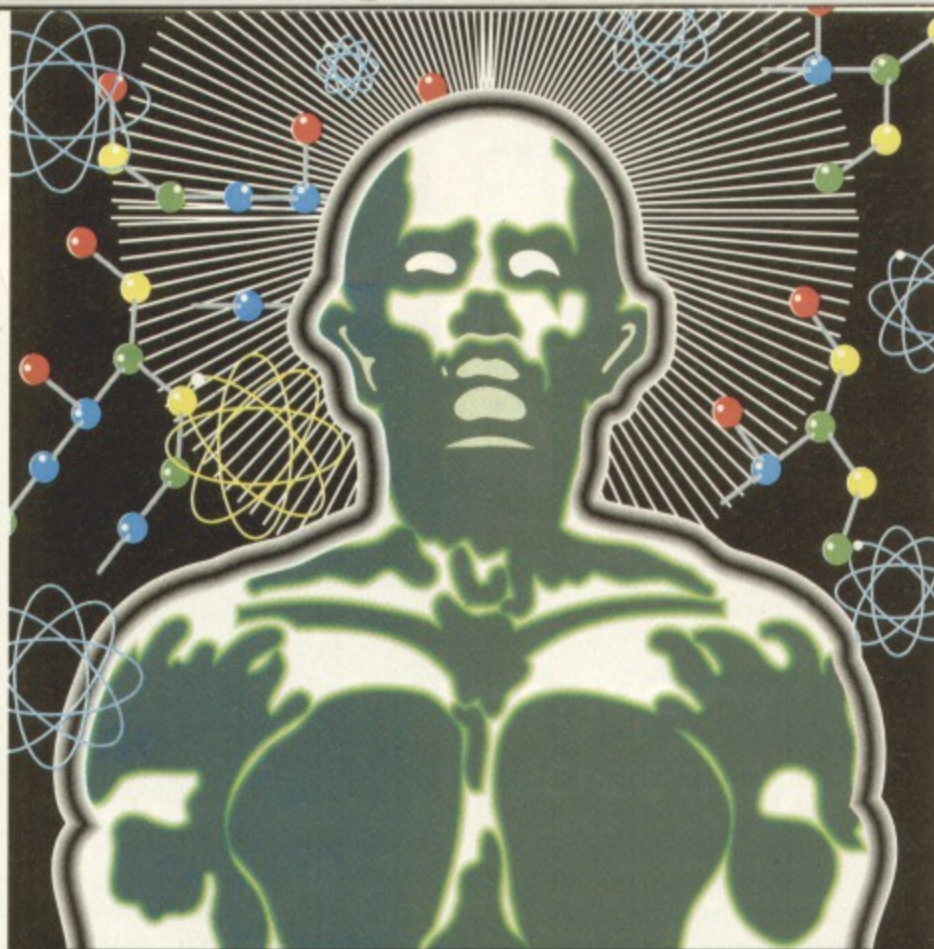

## The Beeb Body Building Course

# Capacitor Investigations

*Mike Cook embarks on Part 5 of the I<sup>2</sup>C bus adventure*

and see what happens. The circuit in Figure II shows how we can use our I<sup>2</sup>C board to do this.

Analogue input channels 0 and 1 are used to measure the applied voltage and the capacitor voltage and inputs 2 and 3 are used together as a differential input to measure the voltage across the resistor, hence give the current flowing.

As you will see, we split the resistor into two and only use half of it as a current probe. This is because the maximum voltage of the differential amplifiers is only half that of the single ended inputs. The voltage range is the

same, however, as the differential inputs copes with both polarities.

Note that we don't use the buffered output of the board because we used an emitter follower buffer which means that the output is good at sourcing current but not at sinking it. While the capacitor will charge in response to an increasing applied voltage it will not discharge when the voltage drops below the

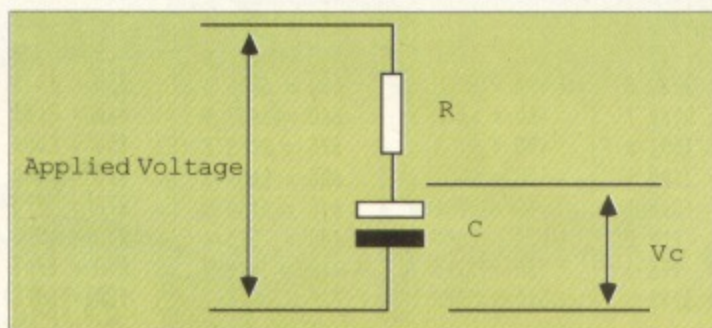

Figure I: R C series circuit

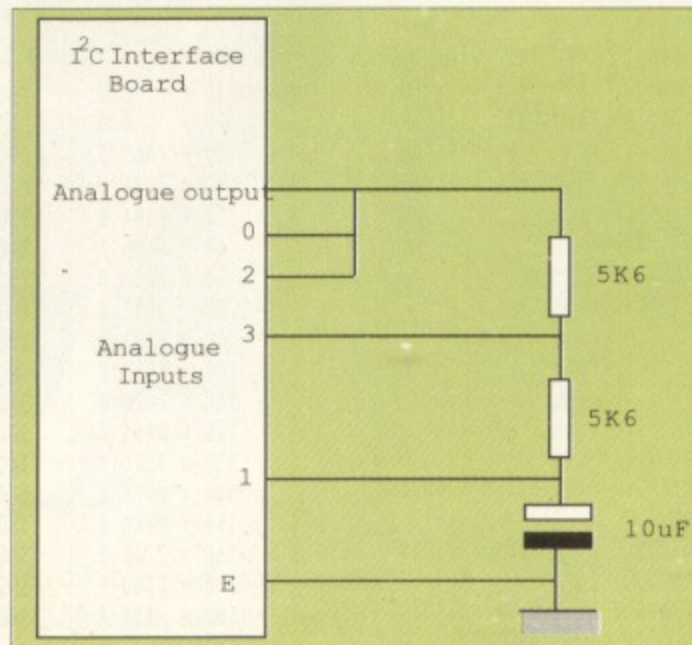

Figure II: The capacitor charging experiment

capacitor voltage.

What we want to do is to feed out a voltage and measure the values on the three channels. To allow us to do this as quickly as possible we pre-calculate the output voltage waveform in an array.

Then when the readings come in we plot them directly on the screen in white. In this way we see the readings as they come in. The alternative way is to store the readings in an array for later processing.

It would be nice to be able to show the various traces in different colours, but this would take up time changing the graphics colour. So instead we plot them in white and colour them in later on.

The program to do all this is shown in Listing I. The heart of the program is PROC\_CPLOT in lines 450 to 680, which does all the work of inputting, outputting and plotting.

Note that the differential input channel gives the reading in two's complement form. In order to change this to a form suitable for plotting on the screen we invert the most significant bit with an exclusive OR statement.

Before this procedure is entered we generate the voltage waveform we are going to use in the five procedures at the end of the program.

We can choose between square, sine, triangular and two types of sawtooth waveforms. The array *Vout%()* is filled with the appropriate values.

Having made the plot, PROC\_PROCESS in lines 310 to 520, tidies things up, colours the waveforms, puts on the axis and finally labels each waveform.

The technique for colouring the waveform is interesting and deserves examination.

The first part of the trace is likely to





BODY BUILDING

be non-characteristic due to the initial conditions on the capacitor. We can use this initial portion to put the labels in. However, it is useful to see them at the start of the trace.

We plot the waveforms in white. In this mode this means that 7 is placed in the computer's screen memory. If we then cover the whole waveform with a filled in rectangle we would not normally expect to see it.

But if we use GCOL action 2, AND with existing colour the black will safely stay black and the white will be converted to the current colour.

In over eight years of programming Acorn machines this is the first time I have found the AND action in the GCOL statement to be useful. It's been a long wait, but thanks for putting it in lads!

So what do we see? Well with a square wave of just a few cycles we have the normal charge and discharge waveform. Note that the current trace at

the bottom of the screen indicates that current is flowing both into and out of the capacitor. This is indicated by the green trace going both above and below the axis.

If we increase the number of cycles we will see the voltage across the capacitor does not have time to reach zero or full – the amplitude of the signal decreases.

The current waveforms are the inverse of the voltage ones. However they are not simply the magnitude inverse, but the exponential inverse. You can see the initial inrush of current and then it drops exponentially.

What happens with a sine wave? At first it appears not very much – you just get three sine waves. But take a closer look at the difference in phase between the capacitor voltage and the current. You will see that there is a 90 degree phase shift between them.

There is also a phase shift between the applied and capacitor voltages. This is not a simple 90 degrees like the voltage current relationship. In fact it will

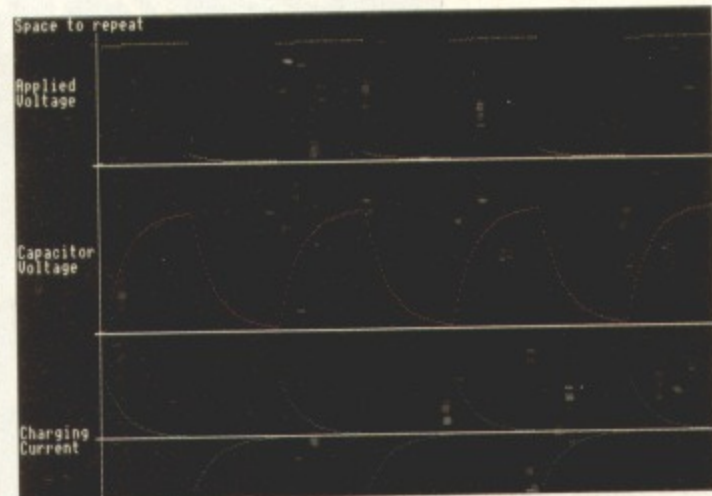

How the output looks

change as the number of cycles or input frequency changes.

Also note that the amplitude of the capacitor voltage drops as the frequency gets higher. This is the basis of a filter. I will leave it to you to see what happens with the other waveforms. See if you can explain them with what we have learnt here. You can experiment with different values of  $R$  and  $C$  and so alter the time constant of the system.

If the resistor is made too big you can

get drift upwards on a square wave. This is because the charge and discharge time constants are not the same due to the differing source and sink impedances of the analogue output.

This is also the reason why when you output a square wave the falling edge is not as sharp as you might think.

● So there you have it. With a very few extra components we have investigated one of the fundamental phenomena of electronics.

```

10 REM >IIC.IIC_CAP
20 REM by Mike Cook
30 DIM PBin% 4,PBout% 3,Vout%(320)
40 MODE 12
50 REPEAT
60 CLS
70 PRINTTAB(0,2)"Beeb Bodybuilding Co
urse September 1991"
80 PRINT"IIC Capacitor Charging Exper
iment"
90 PRINT"By Mike Cook"
100 PRINTTAB(0,7);"Select Waveform"
110 PRINTTAB(0,9);"1 - For a Square Wa
ve"
120 PRINT"2 - For a Sine Wave"
130 PRINT"3 - For a Triangular Wave"
140 PRINT"4 - For a Falling Saw Tooth
Wave"
150 PRINT"5 - For a Rising Saw Tooth W
ave"
160 AS=GET$
170 IF NOT(AS="1" OR AS="2" OR AS="3"
OR AS="4" OR AS="5") THEN PRINT"Try agai
n":GOTO 160
180 PRINT
190 INPUT"How many cycles ";CX
200 CX=CX*2
210 IF AS="1" THEN PROC_VinitSQ(CX)
220 IF AS="2" THEN PROC_VinitSN(CX)
230 IF AS="3" THEN PROC_VinitTR(CX)
240 IF AS="4" THEN PROC_VinitST1(CX)
250 IF AS="5" THEN PROC_VinitST2(CX)
260 PROC_CPLOT
270 PROC_PROCESS
280 AS=GET$
290 UNTIL FALSE
300
310 DEF PROC_PROCESS
320 GCOL 2,3
330 RECTANGLE FILL 0,712,1280,256
340 GCOL 2,1
350 RECTANGLE FILL 0,356,1280,256
360 GCOL 2,2
370 RECTANGLE FILL 0,0,1280,256
380 GCOL 0,0
390 RECTANGLE FILL 0,0,150,1023
400 GCOL 0,7

```

```

410 LINE 150,0,150,1023
420 LINE 140,708,1280,708
430 LINE 140,352,1280,352
440 LINE 140,128,1280,128
450 PRINT TAB(0,4);"Applied"
460 PRINT"Voltage"
470 PRINTTAB(0,15);"Capacitor"
480 PRINT"Voltage"
490 PRINTTAB(0,27);"Charging"
500 PRINT"Current"
510 PRINTTAB(0,0)"Space to repeat";
520 ENDPROC
530
540 DEF PROC_CPLOT
550 ?PBout%=&64
560 REM Set up the control register
570 SYS "IIC_Control",&90,PBout%,1
580 CLS
590 FOR AX=0 TO 320
600 PBout%?1=Vout%(AX)
610 SYS "IIC_Control",&90,PBout%,2
620 SYS "IIC_Control",&91,PBin%,4
630 X%=AX*4
640 PLOT 69,X%,(PBin%?3) EOR &80
650 PLOT 69,X%,PBin%?2+356
660 PLOT 69,X%,PBin%?1+712

```

```

670 NEXT
680 ENDPROC
690
700 DEF PROC_VinitSQ(NX)
710 LOCAL AX,VX
720 NX=320/NX
730 FOR AX=0 TO 320
740 VX=AX/NX
750 IF (VX AND 1) THEN Vout%(AX)=255 E
LSE Vout%(AX)=0
760 NEXT
770 ENDPROC
780
790 DEF PROC_VinitSN(NX)
800 LOCAL AX,V
810 V=(2*PI/320)*NX
820 FOR AX=0 TO 320
830 Vout%(AX)=127+127*SIN(V*AX)
840 NEXT
850 ENDPROC
860
870 DEF PROC_VinitTR(NX)
880 LOCAL AX,SX,CX,DX
890 CX=320/NX
900 FOR AX=0 TO 320
910 DX=AX MOD CX

```

```

920 Vout%(AX)=(255*DX)/CX
930 SX=AX DIV CX
940 IF (SX AND 1) THEN Vout%(AX)=255-V
out%(AX)
950 NEXT
960 ENDPROC
970
980 DEF PROC_VinitST1(NX)
990 LOCAL AX,V,CX,DX
1000 CX=320/NX
1010 FOR AX=0 TO 320
1020 DX=AX MOD CX
1030 Vout%(AX)=(255*DX)/CX
1040 NEXT
1050 ENDPROC
1060
1070 DEF PROC_VinitST2(NX)
1080 LOCAL AX,V,CX,DX
1090 CX=320/NX
1100 FOR AX=0 TO 320
1110 DX=AX MOD CX
1120 Vout%(AX)=255-(255*DX)/CX
1130 NEXT
1140 ENDPROC

```

10 = 0 0	190 = 8448 B
20 = 0 0	200 = 39B9 4
30 = 7AD5 5	210 = FAEE E
40 = 3C86 C	220 = 9B3F A
50 = BFBA B	230 = 2C3E C
60 = 7A16 F	240 = 4752 C
70 = 706A 0	250 = 779F 0
80 = 781F D	260 = 1F22 B
90 = FC23 B	270 = 971D B
100 = E85E E	280 = 77F2 E
110 = D626 6	290 = 226C 8
120 = BE68 6	300 = D1AD 7
130 = 3326 E	310 = 1DD2 D
140 = B078 D	320 = 2FB9 4
150 = DAE6 3	330 = F0F5 E
160 = 77F2 5	340 = FFB C
170 = C3EB 9	350 = 153 3
180 = FF3E 6	360 = 3F98 6

370 = 4752 9	550 = 32C9 E
380 = 71BA 7	560 = 0 E
390 = 5956 1	570 = 2A34 4
400 = 15D 6	580 = 7A16 C
410 = C6A8 6	590 = D5FA 3
420 = E14E 7	600 = C4E3 9
430 = 732A A	610 = 1A57 1
440 = 9E01 3	620 = ED3D E
450 = F234 1	630 = C843 9
460 = 462E 1	640 = DD7D D
470 = 5ECE C	650 = 6005 3
480 = 462E 5	660 = DE57 9
490 = F755 C	670 = 2C83 8
500 = C491 C	680 = ED0F 5
510 = B2FE A	690 = D1AD 1
520 = ED0F 0	700 = 75E3 6
530 = D1AD 7	710 = CDEE 7
540 = 89EC 1	720 = D9E4 9

730 = D5FA B
740 = FDF0 7
750 = 8819 7
760 = 2C83 B
770 = ED0F F
780 = D1AD 7
790 = 1440 0
800 = 928 7
810 = C5F0 1
820 = D5FA E
830 = A123 B
840 = 2C83 5
850 = ED0F A
860 = D1AD 1
870 = 5370 9
880 = 405B 7
890 = 87D7 1
900 = D5FA F

910 = E8ED C	1040 = 2C83 0
920 = FAB7 6	1050 = ED0F 9
930 = 8DE9 3	1060 = D1AD 0
940 = 5F6F 3	1070 = 2930 4
950 = 2C83 C	1080 = 4E49 D
960 = ED0F D	1090 = 87D7 8
970 = D1AD F	1100 = D5FA E
980 = C7E2 3	1110 = E8ED 9
990 = 4E49 7	1120 = 7461 A
1000 = 87D7 3	1130 = 2C83 5
1010 = D5FA E	1140 = ED0F E
1020 = E8ED C	1150 = D1AD 0
1030 = FAB7 7	



# JAHANGIR KHAN World Championship SQUASH

JAHANGIR KHAN, the World's number one Squash Player, now brought to the small screen by Krisalis Software.

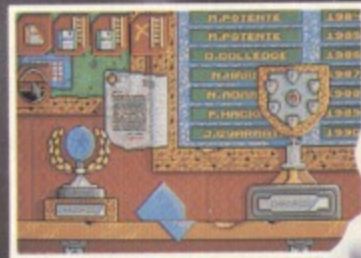
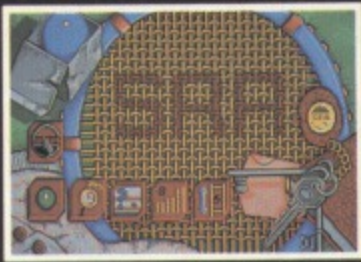

The game features two stand alone simulations, Club Level, which is officially endorsed by the Squash Rackets Association, this allows the player to compete in Squash Club Competitions, using menus which include an eight rung league ladder containing forty players, ball speed control using spot colour option,

Match length one, three or five games, play by new or old rules and player statistics. World Championship, the game simulates all the excitement and tension of the 32 seed World Championship Knockout competition.

Play one on one two player option, or head to head against the computer.



AVAILABLE FOR:  
ARCHIMEDES  
& BBC A3000  
**£25.99**



Release Date 6th Sept 91. Available from your usual retailer or direct from Krisalis Software, sending your cheque or postal order. Or telephone your order using your Access or Visa card. Orders dispatched 6th Sept 91.

Endorsed by



Squash Rackets Association



**T**o produce a squash game for a computer, is quite something, but to include features such as league tables and graphs is something else. This new release comes in the form of a boxed package with a leaflet explaining the rules of squash and the various features.

The documentation was for the Amiga version, so I spent the first half hour trying to find what the keys were. However, the game also works with the Serial Port joystick, which is a vast improvement on keys or mouse.

On loading you are greeted with a catchy tune and an options menu. At this point you must choose the language that the game should be in and pick whether you wish to play World Championship Squash or Club Tournament. This feature

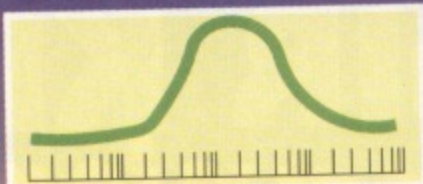

**Software  
SCENE**



Price: £25.53  
Supplier: Krisalis Software Limited,  
Teque House, Masons Yard,  
Downs Row, Moorgate,  
Rotherham.  
Tel: 0709 372290  
Requirements: BBCA3000/  
Archimedes



# Jahangir Khan World Championship Squash

*...tough time in court*

should ensure the game's viability in Europe - 1992 and all that. The only annoying bit was that the screen pointer can only be moved using keys and not the mouse.

The World Championship section is almost identical to the Club Tournament mode except that the

latter allows a gradual improvement of your skills before you move on to battle against the best in the bid to become champion.

On the main selection screen you can view other players' attributes, watch their matches, choose one or two opponents - to play against a

friend, save and load matches and even change the ball type and the rules.

I began with a practice match against a computer player in a clear transparent court surrounded by spectators. A scoreboard sits in the

top left corner with the ball type opposite.

The audience applaud and with a twist of the racket and a shake of the hands you serve the ball and the match begins.

The ball bounces against the rear

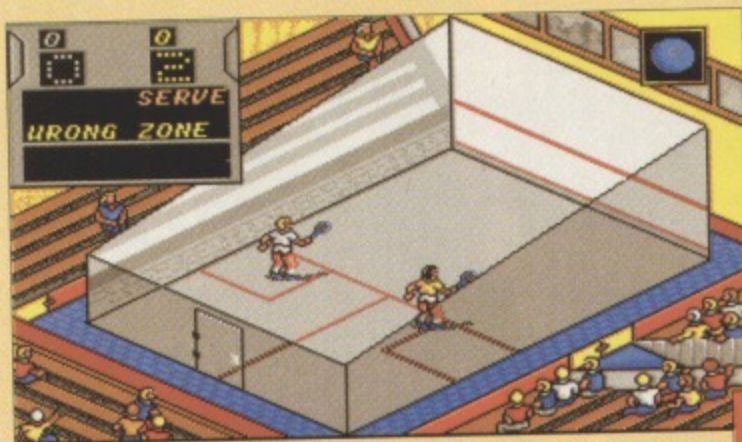



wall and your opponent attempts to return it. Sampled bouncing noises add to the realism as I tried to return the ball. You are able to hit to the left and right with varying amounts of power.

I found it very difficult to judge exactly where the ball was going to drop, and quite often ended up fumbling around where I didn't want to be.

When I did manage to whack the ball back I found it extremely hard to keep a rally going, and most of the time found that when I served I was promptly informed by the comments box under the scoreboard that the ball had landed in the wrong zone.

Further investigation of the instructions revealed that I could change to an easy mode – which unfortunately made no difference to my service or returning skills.

Needless to say, I lost the match and found my opponent waving his arms in the air, obviously congratulating himself.

With a little practice though, a rally can be started and there's a great sense of achievement when you win a point.

When you move on to a proper match your opponents gradually get tougher. If you can convince a friend that Squash is his kettle of fish you can use the two player option at your own pace to improve your game.

To round off, this new release is totally different to anything else around at the moment and with its vast array of management options makes an ideal game for anyone who likes a real challenge.

**Brett Colley**



Price: £19.99 inc VAT  
Supplier: CIS, Unit 2a, 436  
Essex Road, London N1 3QP  
Requirements: Archimedes/BBC  
A3000

# Fish! Jinxter, and Corruption

*...three for the price of one*

**G**ENUINE bargains are not easy to find, even in these days of recession, however, I can confidently report that one has come my way. The Magnetic Scrolls adventures *Jinxter*, *Corruption* and *Fish!* have been released as a compilation at a price which would be quite acceptable for any of the games individually. This really is a bargain.

I remember quite clearly the first time I saw one of these games on my Archimedes. From being a pretty rigid text-only purist, I was won over to the concept of illustrated adventures by its pictures were of photographic quality.

The fact that these adventures are illustrated doesn't mean that the text itself falls short in any way. The descriptions are full, well written, witty and – at times – contain humour of an anarchic flavour.

All of this appeals to me and, should I ever be in a minimalist mood, I can always turn the graphics off and play the games as pure text adventures. For me, that is as close as you can ever come to eating your cake and having it.

The packaging is sparse but adequate, and clear instructions are supplied on how to load each game or install it on your hard disc. Also a number of encrypted clues are progressively revealing. In other words, you are given everything you need to play each adventure successfully.

Advice is given on



performing housekeeping chores in order to release enough memory on 1Mb machines, and this certainly worked for *Jinxter* and *Corruption* but I had to free more space for *Fish!* by unplugging some modules.

I cheated here and used the Config program supplied with *Wonderland* to speed things up. I lost sound, but it worked.

Each plot is completely different, which helps to make this compilation such a bargain.

In *Jinxter* – once you have solved the initial small puzzle – you are co-opted by a cheese-munching Guardian (angel?) to deal with Jannedor the evil wosname, er

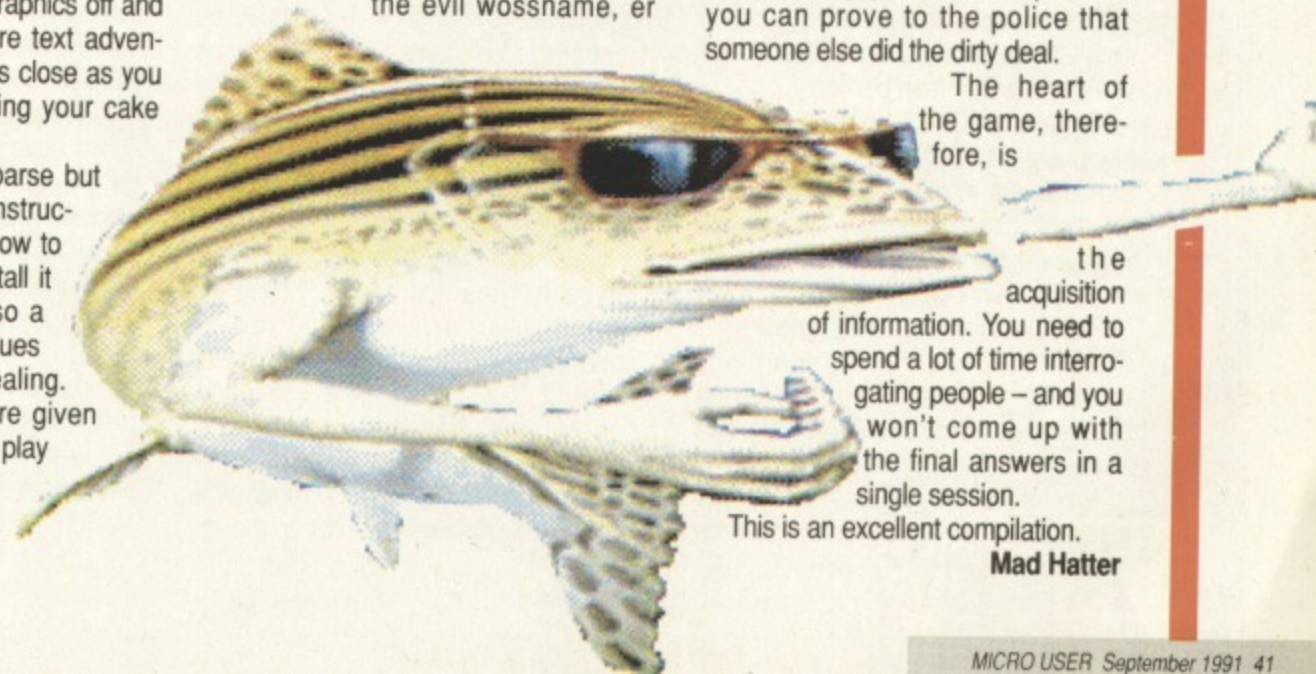

who with her cronies is troubling Aquitania. To do this you must locate five charms and restore them to the legendary Turani Bracelet.

The task is similar to many an adventure that derives its inspiration from Tolkein and other writers, but the setting in reassuringly mundane until you reach Jannedor's castle.

Most of the items you encounter can be put to use in *Jinxter* but sometimes a fair bit of lateral thinking is required – and this is where the clues come in handy, nudging you in the right direction.

I particularly liked the initial clue for those who are troubled by the bull: *Ask a vicar, he's a man of the cloth*. When you have completed the task you get run over by a bus, which may seem unfair, but since that is how you started the adventure, I suppose it's wosname, logical.

A great game for beginner and seasoned adventurer alike.

*Fish!* is a little more difficult. It has a similarly zany start to the main game – in this case you are a goldfish swimming happily in your bowl when you are bashed on the head and lose your equilibrium.

It's a tripartite adventure really, as there are three warps to enter at the behest of Admiral Sir Playfair Panchax in your effort to thwart the Seven Deadly Fins. I don't think I am betraying too much if I say you should try the smooth warp first.

The first task is one long chaining puzzle involving matters metallurgical, and a delightful romp it is too, as it involves one of my favourite feathered friends, an exploding parrot.

Timing is often critical in *Fish!*, and it can help if you ask people to do things for you promptly.

Trickiest of the trio is *Corruption*. Again, this is an adventure where timing is absolutely critical on many occasions. You really do have to be in the right place at the right time.

You are offered a partnership in the City firm of Rogers and Rogers: You are also fall guy for a frame-up unless you can prove to the police that someone else did the dirty deal.

The heart of the game, therefore, is

the acquisition of information. You need to spend a lot of time interrogating people – and you won't come up with the final answers in a single session.

This is an excellent compilation.

**Mad Hatter**



Price: £24.95  
 Supplier: The Fourth Dimension,  
 1 Percy Street, Sheffield, S3  
 8AU.

# Saloon

... driven to distraction

# Cars

**T**HIS is the third racing simulation to appear from Fourth Dimension, after E-Type and Powerband, and the third to appear on the Arc, Chequered Flag from CIS is due "real soon now".

In this scenario you are an amateur racing enthusiast at the controls of a saloon car. Initially you own an Astra GT but perform well in the races and you may gain sponsorship enabling you to progress to class B.

From the initial menu screen it is possible to select a bewildering range of options. I started with the practice mode. The graphics were impressive but rather static. A quick stab at the keyboard and I found the starter. Starting the engine is much like a real car, several turns of the key are usually required to get the engine turning over.

At this point the speaker bursts into life and the screen starts bouncing up and down slightly to give the impression of a revving engine. I found the accelerator and revved the motor but the eager little car still did not want to move.

Further experimentation revealed a hand brake which has to be taken off and an automatic gearbox which must be put into drive.

Finally pressing the accelerator button on the mouse caused the car to surge forward and then to the right - straight into the crash barrier.

Subsequent incompetence resulted in the car crashing, at low speeds, into the spectator stand, a parked car, several traffic cones and finally after reaching a decent speed, another fast moving car on the track.

The graphics are very impressive - 256 colours with the screen being updated at a very fast rate. The display seems to be a mixture of scaled sprites and solid vector.

The attention to detail is superb. The screen bounces when the car goes on

to the verge or hits something. There is loads of scenery and most of it is scaled very realistically to give a good impression of speed.

Hitting the cones on the track results in a realistic thumping noise.

I was a little disappointed by the rear view mirror - the trouble is that given the quality of the front view I expect the mirror to match it. Instead it only shows a straight road even when the car is 90 degrees to the track with its front bumper buried in the crash barrier!

The mirror's only use is to see if any cars are trying to get past.

My initial impression was that the car was very difficult to control. I spent most of the practice session bouncing from one side of the track to the other. The mouse control on the steering seemed unreasonably sluggish.

I finally crashed once too often and was treated to the end of game sequence, which is quite horrible!

I had to admit defeat and resigned myself to reading the manual in some depth. I was most concerned about the control of the car, or lack of it. On this subject the manual starts by saying: *This one can be conveniently ignored most of the time.* In the case of my driving this is probably not a good idea.

The pamphlet goes on to talk about the use of an analogue port and describes how such a device can be controlled from a home made steering wheel and pedals. This may be a good idea if you are really keen on racing games, but all I wanted was a decent way to control the car using existing Archimedes hardware.

It also mentions such options as buying better tyres and brakes. They are not particularly expensive and you are initially provided with plenty of spare cash.

Back to the track and with new tyres fitted, ABS brakes and an extra sensitive mouse option, practice mode was reselected. Control was better, though



by no means perfect - extreme concentration was required to keep the car on the track. I became very frustrated with having to keep reversing off barriers.

It was becoming obvious that a great deal of practice would be needed to get the best from this software. But being a review, time was short so the race option was selected.

This resulted in a message informing me that my car could only be used for practice. This meant having to load data for another car, which was a nuisance. The automatic was loaded, as this sounded the easiest to drive.

I accelerated out of the pits and spent several minutes veering erratically round the course while other cars whizzed passed me with total disdain. eventually I became totally disorientated after a crash and ended up driving the wrong way up the track. This resulted in an impressive head-on crash and my being banned from the circuit for dangerous driving!

I was really disappointed at not being able to get started, as technically Saloon Cars is a breathtaking piece of

programming and a stunningly accurate simulation. With a lot of practice I expect it becomes easier to drive, but the difficulty at the start is quite daunting - you'll have to be really dedicated to get into it. Perhaps the addition of a silly-easy level would help.

Geoff Brown

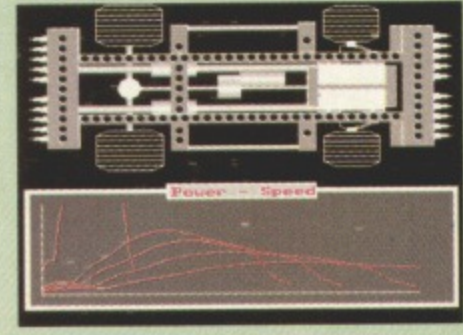

# TOP BANANA



## Frantic Fruit Fight to Save the Planet



**TOP BANANA** is a mega-ARCADE romp in which you use your power of Love to save our Planet from impending ecological disaster and release hidden hoards of succulent riches.

- **GAMEPLAY** - 4 separate Worlds of juicy addictive Coin-Op action.
- **GRAPHICS** - 3 level parallax scrolling with 256 colour sampled video graphics.
- **SOUND** - Solid sampled cyber-mixed sound. Gives a groovy sequenced dance track and individual atmosphere for each World.
- **HARDWARE** - 1MB Archimedes and A3000 machines. RTFM Joystick compatible.
- **SOFTWARE** - Includes quality loose fit T-Shirt with exclusive design and non-fade print.



To order Top Banana send a cheque or Postal Order for £25.99 (inc. P&P) payable to HEX addressed to HEX, P.O. Box 737, London SE5 9JG. Credit card holders dial 071 701 0652 for 24hr ordering service. For each extra T-shirt please add £6.99.



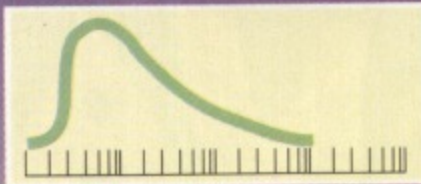

**Software**  
**SCENE**

60%

Price: £24.95  
Supplier: Micro Power Ltd.,  
Northwood House, Leeds LS7  
2AA.  
Tel: 0532 458800

**W**ICROPOWER have produced many first rate games for the eight bit BBC Micros but to my knowledge this is their first arcade offering on the 32 bit scene.

After a rather dull introductory sequence play starts in space invaders style. You control a small craft which can be manoeuvred left or right across the bottom of the screen. The invaders start at the top of the screen and progress down moving left and right as they come. You shoot up at them at the same time as they fire back down at you.

I was initially disappointed. The quality of animation was excellent and the

# Zelanites the Onslaught

*...blast from the past*

detail of the attacking aliens of a high standard, but I felt let down by the old fashioned gameplay.

However things soon started to pick up. Tokens can be collected which boost your weapons and provide shields and so on. On later levels the aliens start to break formation and zoom down at you Galaxian-style.

After five different levels, each introducing a new type of alien, you move

on to the second stage. However, apart from a different back drop and a few new aliens, gameplay seemed to continue much the same as before. I quickly became bored.

The program also suffered from rather spartan presentation and there was no music during the game or title sequence. Sound effects, though adequate, could hardly be described as breaking new ground. There was no

joystick option – a shame, for here a joystick would add a whole new dimension to the playability.

Also there should have been an option to skip completed levels. The later levels in Zelanites are quite interesting, but to reach them means ploughing through the early levels which are easy but time consuming.

The programming was excellent. The animation runs at a steady 50 frames a second with no flickering or jerkiness. It is also initially very playable. I had no difficulty getting into the game – I just needed a little more variety to keep me hooked.

The above faults apart, this is probably the best game of the type currently available for the Acorn 32 bit machines. With 256 colours on screen and ultra smooth animation it really knocks spots of similar games on the 16 bit format.

Pricewise it's pretty steep, but having said that the girlfriend loved it.

Tony Oakden



# Provocator

*...plenty of bullets*

**W**ITH the threat of death on your home planet from the sun going supernova, you and your people have assembled a giant space convoy and fled deep into space in search of a new home.

All was well until your spaceships strayed into alien territory and came under heavy attack. Your mission is to protect your ships and their cargo by preventing the vital oxygen-supplying vegetation domes being destroyed by the alien vessels.

At first this is a relatively easy task. At first the shields of just one have failed. However, as the number of alien attack craft increase and more shields fail, your mission becomes progressively more difficult. The game features some incredibly intricate foreground sprites, especially those representing the convoy – extensive use of grey levels giv-

ing a semi-three dimensional feel.

Movement is really smooth – a great asset of most games on the 32-bit Risc machines – and also very responsive to keyboard commands.

Control is easy to get the hang of: Six pre-defined keys are used to govern up/down movement, left/right direction, thrust/turbo and, of course, firing.

An accurate radarscope is displayed near the top of the screen and comes in very useful – especially when detecting which domes are vulnerable and under attack.

In fact, on the higher levels I found it easier to play the game by watching the radar and using it to employ a seek-and-destroy method of combating the aliens.

The graphical display is quite accurately maintained and true to life in speed representation. However, one thing did stand out: When thrust or turbo is used, the foreground sprites move at a rate of knots, but the starfield at the back

continues at a slow, uniform pace.

Sound is limited and used only to enhance explosions, firing and *dock now* warnings: There is no fancy tune to accompany the game. Really it's not the sort of audio quality you would normally associate with 32-bit power.

You have three lives at the outset, and holding on to them is not that easy. There is no password facility, so every mission starts on the first level regardless of how far you have gone before.

This is one game where you certainly need your wits about you: It's fast, furious and requires plenty of concentration – perseverance and quick reactions are the key to success.

Provocator is about £5 cheaper than many of the other shoot-'em-ups now available for the Archimedes and, although it does not seem to have the same long-lasting addictiveness, is worth considering.

Stephen Wade

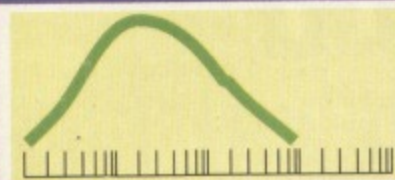

**Software**  
**SCENE**

65%

Price: £19.95  
Supplier: Computer Tutorial  
Services, 4 Mill Hill, Cowes, Isle  
of Wight PO31 7EA.  
Tel: 0983 294333  
Requirements: BBC A3000 or  
Archimedes (1Mb minimum)

# QUALITY ARCHIMEDES SOFTWARE FROM MICROPOWER

From the Publishing House which brought you 70+ superb programs for the BBC Micro and 40+ superb programs for the Acorn Electron comes

## ZELANITES THE ONSLAUGHT



**H**AVING BEEN DEFEATED IN SEVERAL PREVIOUS ATTEMPTS TO TAKE & DESTROY THE HOME PLANET, THE ZELANITES HAVE RE-GROUPED, RE-EQUIPPED & THROWN ALL THEIR RESOURCES INTO BUILDING THE LAST WORD IN SPACE ARMADAS.

**H**OME PLANET DEFENCES HAVE ALSO BEEN STRENGTHENED, SETTING A FOUR STAGE ARENA FOR THE INVADING ZELANITES TO TACKLE.

HOPING TO PRESERVE MUNITIONS FOR FURTHER CONQUESTS, THE ZELANITES EMPLOY THEIR WEAPONRY WITH INCREASING INTENSITY AS THE BATTLE PROGRESSES.

**Y**OUR TASK IS TO SEE OFF THIS MASSIVE ONSLAUGHT & BUY THE TIME NECESSARY TO RE-BUILD YOUR PLANETS DEFENCES.

For the  
Archimedes  
A3000

**PRICE £24.95**

VISA/ACCESS

Please add 0.95p post & packing  
cheques/P.O.'s payable to

Requires  
1Mb memory  
Risc-os

### GAME FEATURES

Written entirely in highly optimised assembler in 256 colour mode, the program has customised sound generators using 4 stereo sound channels, up to 70 objects on screen simultaneously and beautifully smooth animation. Playability and increasing levels of difficulty make this program a "must" for all arcade-game enthusiasts.



### AUTHORS

If you have written or are writing software of commercial standard and would like your work published in a professional manner, please write to Bob Simpson at the address given, preferably with a sample of your program.

MICRO POWER LTD MU91 NORTHWOOD HOUSE  
LEEDS LS7 2AA TELEPHONE 0532 458800

# Break 147 & Superpool

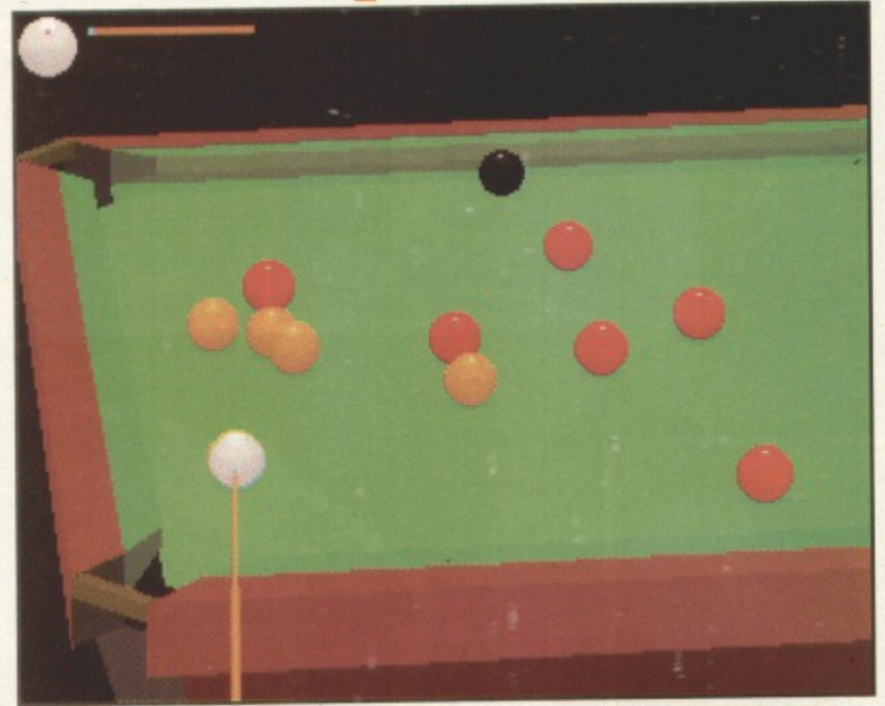
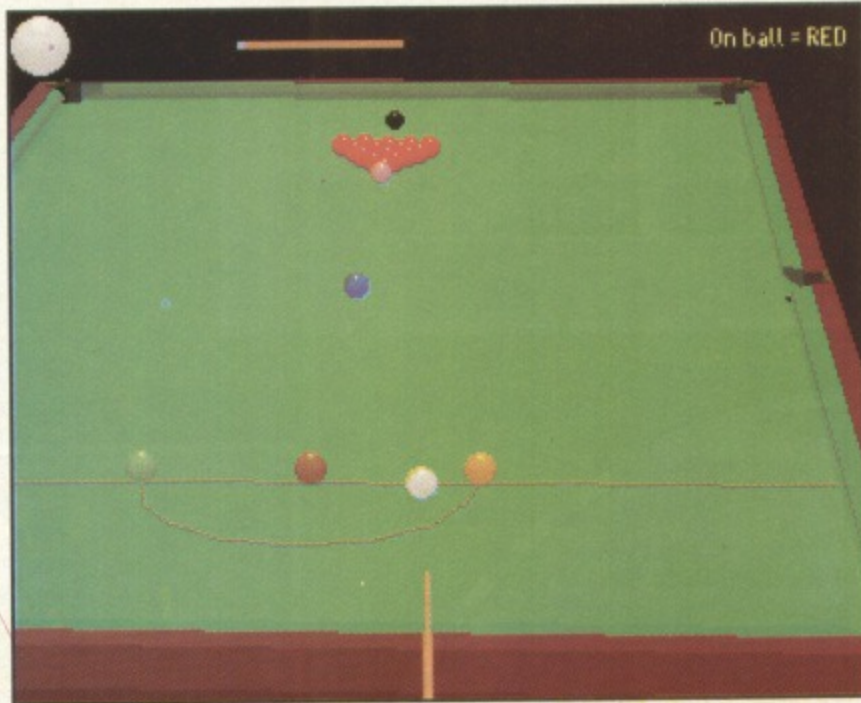

**"Snooker & Pool Simulator Par Excellence"**

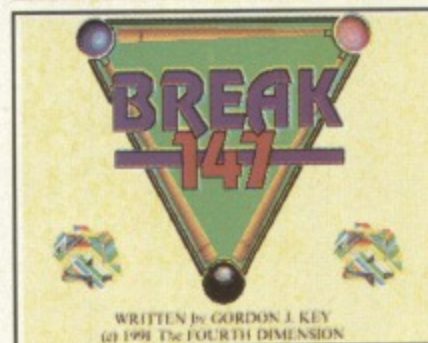
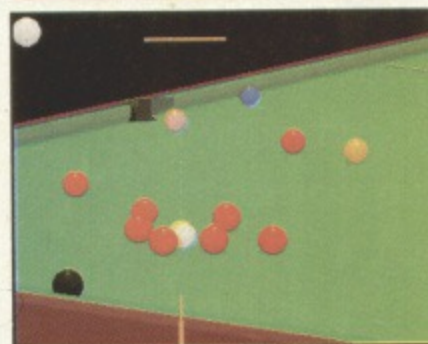
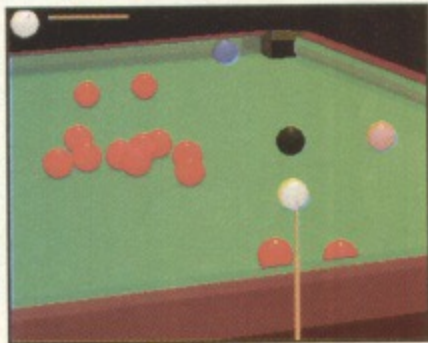

*'BREAK 147' and 'SUPERPOOL' are game simulations in the true sense of the word. Gone are the power meters and fixed screw and side settings of inferior simulations and in comes a cue driven by reality software.*

As in the real thing your grip on the butt of the cue (represented by the mouse), the smoothness and power of your cue action and the way in which you follow through with a shot, are all deciding factors in whether a pot is successful and whether you will retain position for the next ball. The only thing that is missing is the smokey air and a pint of beer on the edge of the table, these you will have to provide for yourself!

In both games you can choose to play on a practice table where anything goes. You can position balls wherever you wish so that you can improve your potting and positional play. You can even undo unsuccessful shots so that you can try them again. When you make that incredibly fine clip into a pocket or miss by the merest fraction, you can watch an action replay of the shot from any angle so that you can either gloat or see where you made that tiny mistake that let you down.

When you feel that you are up to the task you can play a single match against a friend or against one of the sixteen computer players. Should you feel lazy you can just sit and watch whilst two computer players battle it out between themselves. Alternatively you can enter a tournament where you will have to fight your way through the preliminary rounds and on to the coveted Final.

Whilst you are playing a match or in a tournament the game will be overseen by the referee. If in snooker you are 'on' a colour as in real life the referee will indicate the ball to you that he thinks you are going for and it is up to you to let him know if he is wrong. The referee will also call when a freeball is to be given, if there is a touching ball and your score after each successful shot.



## SPECIFICATIONS

256 colour MODE 13 graphics optimized for maximum speed  
225k of machine code  
Over 147k of high quality sampled speech and sound effects  
Ball plotting accuracy of  $\pm 0.05$  of an inch on a 12 foot table  
Cue butt controlled by the Mouse  
Bridge hand controlled by Keyboard

**BBC A3000 & ARCHIMEDES PRICE £24.95**

"Break 147 & Superpool" is compatible with the BBC A3000 and 310 & 400 Series

## DEALERS

Most of our games are available from most good dealers. If they don't stock them, then please give them a copy of this advert & tell them they can easily buy them directly from us.

## SUPERFAST 1st Class FREE Delivery

### LETTER

Simply send us a quick letter telling us the game(s) you require, your name and address, and payment via cheque, postal order or ACCESS or VISA card details  
**The Fourth Dimension, 1 Percy Street, Sheffield, S3 8AU, England.**

All orders are despatched immediately by 1st Class post. Carriage is paid by us in the U.K. (Overseas orders add £3 per product).

FULL DETAILS OF ALL OUR GAMES ARE AVAILABLE ON REQUEST & ARE SENT WITH ALL ORDERS.

### TELEPHONE

TELEPHONE ORDERS

WELCOME

**(0742) 700661 / 769950**  
ACCESS & VISA Accepted  
24 hour Service 7 Days a Week

## THE FOURTH DIMENSION

1 Percy Street  
Sheffield  
S3 8AU  
England  
Tel. (0742) 700661  
or 769950

# Diary of a game

*The end is near,  
but Steve  
Parkinson suffers  
an unavoidable  
delay*

*May*

**S**POILT myself silly this month with a couple of weeks in Canada. When asking about the availability of Acorn machines I got some very strange looks. Not a BBC Micro in sight. How on earth do they live?

Jet lag has caught me and I'm going to bed for a couple of days...I appear to have mislaid Friday...

Kicked off by designing the countdown timer. The graphics had been done previously but they needed stretching a little, and why not, there's so much memory to play with (joke).

Started off with one digit rolling around vertically from nine to zero and back again. Once this was working adding the other eight digits was a mere formality.

The clock's code is separate from the main code and is called regularly on interrupt. This enables the countdown to continue smoothly even if the processor is bogged down with lots of other tasks.

It's no good! I have had it up to here – finger points above head – with the Beeb's chronic lack of memory resulting in continuous use of the disc drive when assembling.

A dawn raid on the piggy-bank resulted in my investment in a brand spanking secondhand Master – it's really worth the debt.

It took a while to become accustomed to the new memory layout and the month is rapidly approaching ... er ... well, the end of the month.

No manual was provided, but with the help of the Advanced User Guide I

discovered I could have the Basic program, the code and the sprites resident simultaneously. Amazing.

Updated the code to allow for the new memory positions and found no real problems. I've set it up so that the game code adjusts the memory banks to bring in the sprites, then switches the banks back to make the Basic code available when it's exited. The disc drive is almost redundant, but I still make regular back-ups.

After a lot of fiddling around with priorities I adjusted the object position table to accommodate up to three more control towers, although only two were enabled at the start. This wasn't a problem, as it simply has to print more objects.

The problems started when it came to determining which tower had been destroyed and which hadn't – a seemingly simple task. The program remained adamant that the tower which was first in the table was the first one to be destroyed.

A careful examination of the code revealed that it was doing exactly what I had – unintentionally – told it to do, and was executing it beautifully.

Dealt with the radar to stop it displaying destroyed control towers, which involved clearing the display and redrawing it. For maximum speed the object print routine was similarly adapted.

To keep track of which tower was destroyed was a simple matter of a flag – zero for a dead tower and one for a live 'un. After a short while I realised that this problem was similar to one I had encountered in the eight-ball section of Hyperball.

As a ball was lost it was removed from the table completely and all the other balls after it were shuffled up to close the gap.

Scrapped the tagging system for this

slightly better approach. Now once a tower is destroyed the table of data is shrunk and the dead tower automatically removed.

This means that flags are no longer needed, and the various routines only need to know the size of the table. Getting this running was a bit of a headache though. It wasn't very encouraging watching part of the transporter vanish and then re-appear as a group of aliens. Fun, yes. Encouraging, no.

Spent a bit more time installing the other two control towers. This meant the control tower destruction detection code had to be upgraded too.

To prevent too much agro and waste of valuable game time the four towers were located in the four corners of this little universe. The transporter is in the middle.

Slipped in a teensy bit of extra code to give the towers control over certain rocks and girders. The result is that if a mine is surrounded by girders that are controlled by a tower, and you destroy the tower, you'll be in for the chase of your life.

Hm, the game does tend to struggle a bit when all four towers are present, but this will only happen at the beginning of the final few levels. Destroy a couple and it soon slips back into its swiftly moving self.

Redrew the control tower sprites, as they hadn't been included in the universal sprite set. Knew I'd forgotten something.

Checked that the planet routine worked okay on the Master – it was fine. And with the sideways ram that can be held in memory too.

I did toy with the idea of making the planet routine get harder as time went on but it would make the game practically unplayable. The only way I'll know is by playing through the finished version and, believe me, that's not so far away now.

I'm a week into June now and the finals are coming up for my Electronics course. Programming and exams really don't mix so I'll have to put development on hold until July. It's so frustrating as the end is so near...

● *Will he fail his exams because of the game? If there are no Acorns what do Canadians do with their time? And where is the soldering iron? Find out when the game diary returns for July.*

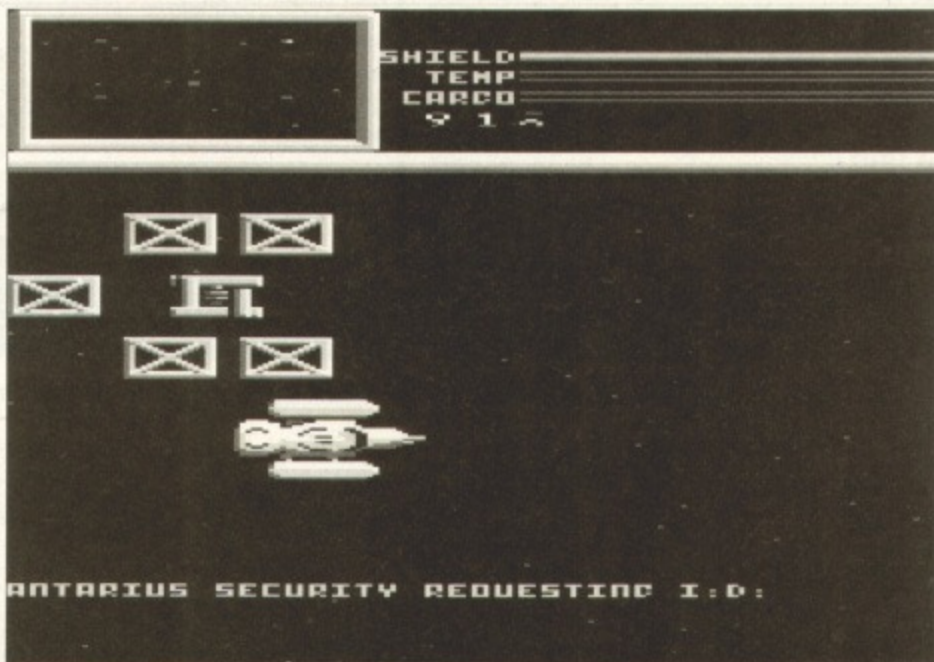

# Orion Computers Ltd.

Qualified Acorn Dealer ☆ Component Level Service Centre

Econet Service & Installation Centre ☆ Citizen Premier Dealer

**PLEASE REMEMBER** when comparing prices - **WE DO NOT CHARGE CARRIAGE**

on standard delivery within the UK. Next Day Courier Service £6.00 Carriage on Export Orders charged at cost.

Dept. MU9, Units 18e & 18f Boxer Place, Moss Side Employment Centre, Leyland, Preston, PR5 3QL. Tel: (0772) 623000 Fax: (0772) 622917  
Callers Most Welcome. We are situated 3 miles from M6 J28. All offers subject to availability. Government & Educational Orders Welcome.

Minimum Order Value £10.00. Minimum Educational Order Value £15.00

## Acorn Computers

BBC Master 128K	£399.00
BBC A3000	£599.00
BBC A3000 Special Access	£699.00
BBC A3000 Learning Curve	£699.00
Archimedes 410/1	£1099.00
Archimedes 420/1 Learning Curve	£1299.00
A440/1 (47 Mb HD, 4Mb Ram)	£1699.00
A540 (100Mb HD, 4Mb Ram)	£2995.00

### Special Offer when purchased with computer!!

- A3000 - £35.00 discount off subsequent items bought with computer, plus either 2Mb Upgrade F.O.C., 4Mb for £100.00
- A410/1 - 20Mb HD + Upgraded to 4Mb F.O.C.
- A420/1 - 42Mb HD + Upgraded to 4Mb F.O.C.
- A440/1 - ARM 3 F.O.C.
- A540 - 4Mb Ram Upgrade F.O.C.

We will try to match or beat any price advertised in this magazine, please phone for best prices.

**We operate the Acorn Education Scheme.**

## Monitors

Acorn Colour Monitor (AKF17)	£200.00
Philips CM8833 II Colour Monitor	£209.00
Microvitec CUB 3000	£199.00
Taxan MultiVision 775 (0.28 d.p.)	£389.00
Taxan MultiVision 795A (0.26 d.p.)	£469.00

## Cables

Arc to Monitor + Audio 2m (Not 8833 II)	£8.65
Arc to 8833 Mk II Monitor Cable + Audio	£8.65
Arc Parallel Printer Cable 1.8m	£5.25
Arc to BBC Serial Cable 2m	£6.95
Arc Keyboard Extension Cable 2m	£7.75
Arc Mouse Extension Cable 2m	£7.75
Arc Keyboard Replacement Cable	£6.95
Arc Mouse Replace. Cable (State Type)	£6.95

We can supply almost any cable made to order. Please call for details.

## A400/1 Accessories

Items marked with an \* can be used on A300/540

1Mb Ram Upgrade	£39.00
2Mb Ram Upgrade	£75.00
3Mb Ram Upgrade	£105.00
Above memory fitted for £10.00	
Acorn SCSI Card	£239.00*
Arm 3 Upgrade	£349.00
Com. Con. Scan-Light Mk II A4	£369.00*
Com. Con. Sheet Feeder for above	£149.00*
Com. Con. Scan-Light + Feeder	£454.00*
Com. Con. Scan-Light Junior	£174.00*
Com. Con. Scan-Light 256	£205.00
Lingenuity SCSI Card	£169.00*
VIDC Enhancer	£27.00
Econet Module	£48.00*
Beebug Disc Buffer	£29.00

## A3000 Accessories

Orion 1 Mb Ram Upgrade	£55.00
(Expandable to 4Mb using only a total of 8 chips)	
Orion 3 Mb Ram Upgrade	£156.00
Serial Upgrade	£18.00
PRES Disc Buffer Board	£48.95
PRES Monitor Stand	£24.95
PRES System Housing	£69.50
CC Scanlight Junior A3000	£174.00
CC Scanlight A4 Mk II A3000	£369.00
CC Sheetfeeder for A4 Scanner	£149.00
CC Scanlight A4 + Sheetfeeder	£454.00
CC Scanlight 256	£205.00
RTFM Joystick Interface + S/W Disk	£34.95
Serial Port Joystick Interface	£18.95
Voltmace DeltaCat Joystick	£26.00

## Books (No Vat)

Programmers Reference Manuals	£77.00
BASIC V Guide	£19.45
A3000 Technical Guide	£28.95
A540 Technical Guide	£65.00
Basic V: A Dabhand Guide	£9.95
Archimedes First Steps	£9.95
Archimedes Assembly Language	£14.95
Budget DTP: A Dabhand Guide <b>NEW</b>	£12.95

### Extra Manuals

Acorn D.T.P.	£10.00
1st Word Plus Release 2	£10.00
ANSI C Release 3	£20.00

## Printers

C.C. Qume Laser Direct	£859.00
C.C. 600 DPI Expansion Card	£309.00
Canon LBP4 Laser for above	£699.00
C.C. 600 DPI LBP8 Laser Direct	£1319.00
(Free Impression II with Qume/LPB8 Laser Direct)	
Canon Bubblejet BJ10e	£249.00
Star LC10	£125.00
Star LC 200 Colour	£175.00
Star LC24-200 Mono	£205.00
Star LC24-200 Colour	£249.00
Citizen 120D+ (Parallel)	£115.00
Citizen 124D	£165.00
Citizen Swift 9	£162.00
Citizen Swift 24	£225.00

## Ribbons

Please call for latest prices on original and compatible branded ribbons. We do not sell "White Box" compatible ribbons.

## Orion Hard Drives

Orion SCSI drives are high speed, typically 750K per second, and the external drives come in a small case. Price includes SCSI expansion card. Please call for current prices. We can supply most drive capacities.

## Arc Software

Impression II (CC)	£129.00
Impression Junior (CC)	£74.00
Impression Business Supplement	<b>NEW</b> £42.00
Desktop Folio (ESM)	<b>NEW</b> £79.00
Schema (Clares)	£99.00
Pipedream 3 (Colton)	£119.00
Flexifile (Minerva)	£119.00
ANSI C Release 3 (Acorn)	£125.00
Multistore II (Minerva)	£199.00
Rhapsody II (Clares)	<b>NEW</b> £44.95
Tracker (Serial Port)	£38.95
Arc DFS (Dabs Press)	£22.95
Dot Matrix Colour Printer Driver (Ace)	£13.00
Poster + Fonts (4Mation)	£79.00
Nevryon (4th Dim.)	£14.45
No Excuses (Arcana)	<b>NEW</b> £14.45
Speech (Superior)	£14.45
ARCTiculate (4th Dim.)	<b>NEW</b> £18.00
Boogie Buggy (4th Dim.)	<b>NEW</b> £18.00
Break 147/Superpool (4th Dim)	<b>NEW</b> £18.00
Chocks Away Extra Missions	<b>NEW</b> £14.45
Chocks Away Compendium	<b>NEW</b> £28.00
Fine Racer (Eterna)	<b>NEW</b> £14.45
Gumshoes (4th Dim.)	<b>NEW</b> £18.00
Interdictor 2 (Clares)	£26.00
Mig-29 Fulcrum (Domark)	<b>NEW</b> £29.00
The Real McCoy 1 or 2 (4th Dim.)	£21.50
Iron Lord (Cygnus)	£14.45
Twin World (Cygnus)	£14.45
Saloon Cars (4th Dim.)	<b>NEW</b> £18.00
Wonderland (Virgin)	<b>NEW</b> £24.50
The Clipart Col. Vol. 1 (Graph. Fac.)	£19.95
PC-Emulator V. 1.60 (Acorn)	£94.00
Investigator II (Serial Port)	£22.95

Please ring for current prices on software NOT listed here

## Bulk Diskettes

All our Disks come complete with labels etc. and are 100% certified error free. In the event that a disk fails it will be replaced immediately.



5 1/4

DS/DD 96tpi

		Quantity					
		25	50	100	250	500	1000
N/A	£14.00	£26.00	£60.00	£115.00	£210.00		



3 1/2

MF/2DD 1Meg

£9.75	£19.50	£34.00	£77.50	£145.00	£270.00		
£12.50	£25.00	£45.00	£106.25	£200.00	£375.00		

Discounts available for trade orders - Phone for prices



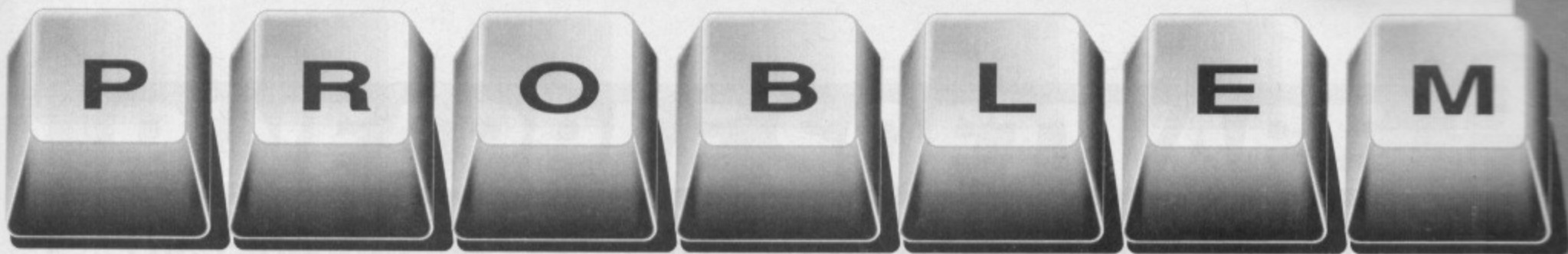

## Your technical questions answered by MIKE COOK

### Hard drive hassle

I HAVE recently purchased a secondhand 10 Mb Winchester disc drive manufactured by Plus 5. I was told that this would plug straight into my BBC B.

Upon examination I found that the IDC connector on the rear of the drive has 40 pins, whereas the BBC Micro has a 34 pin one.

I was advised to use the first 34 pins. This resulted in the computer failing to reset on power-up and not responding to any of the keys including control break.

Inside the drive the 40 pin socket is connected to a 50 way connector on the PCB. This PCB looks similar to that in a Watford unit that I have seen.

But there is no equivalent of the Watford "Winchester Host Card" and Watford do not want to sell me one of these on its own.

The drive itself is made by Rodime. I would be grateful for any guidance you could give, including

supplier names for hardware necessary to enable me to use this drive. — **Henry Pearce, Derby.**

● *If you are plugging a hard disc into a Model B it does not go into the disc drive socket, but normally the 1MHz bus. However, if it really does plug straight into the Model B, the only 40 pin socket is the Tube which would not be right.*

*However, if your advice that it plugs into the computer is correct I think you need a disc interface card and a version of a hard disc filing system.*

*If the card is designed correctly you can use the Acorn ADFS. Unfortunately I know of no one who can supply these cards. Can any manufacturer out there help?*

### Driving at speed

WHAT are the main differences between SCSI and IDE hard drives? I was wondering if there was any significant speed difference between

*a section of ram that is used to hold certain parameters. Some of these contain information for the video chip.*

*If you alter these you will not be able to get any display. However, think about what happened when the computer is first made. There needs to be some way of getting these parameters into ram in the first place, and indeed there is.*

*If you switch the computer on with the R key held down the parameter RAM will be fed with one of two sets of default values. Repeat this procedure and you will get the other set.*

### All is not lost

ONE of our members at a local computer club has managed to break his Archimedes by resetting the RTC registers. Is there any known way to recover the machine? — **Roy Heslop, Birchwood Computer Club.**

● *Years ago we were forever telling people that you cannot break a computer by anything you type in. This is as true today as it was in those early years.*

*However with the increased sophistication of modern computers you can create much more of a mess! The real time clock contains*

### On the agenda...

- Chatting with Amiga's
- Speaking German with an A3000
- Using half a TV
- Printing problems with an Elk
- Making sense of chip chat
- Scart at the beginning
- Torch drive too hot?
- Corrupting influence
- Reading the keyboard quicker
- Sharp monitor practice

them. Is the fact that the SCSI podule is 8 bit and the IDE 16 bit important? — **Kenneth MacLeod, Clackmannanshire.**

● *The SCSI is a general purpose 8 bit inter-computer interface. As such it can be fitted to a wide range of different devices. These include optical discs, scanners and laser printers as well as hard disc drives.*

*The IDE is a 16 bit bus designed specifically for hard disc drives. The extra width gives it a speed advantage over the SCSI and it uses simpler protocols and less expensive drivers, plugs and cables. However at present it is restricted almost exclusively to hard disc drives.*

*So if you want to leave room for other expensive goodies go for the SCSI otherwise go for the IDE.*

### Model machine

I WOULD appreciate it if you could tell me if you have covered the following in any issue.

I wish to construct a machine similar to a plotter with a BBC B controlling X,Y and Z axis. I am a model engineer and the machine must work in metal and wood to good tolerances. I seem to recall at one of the London shows such a device was on sale, but I can get not more information. — **Mike Olive, Basingstoke.**

● *There was a device for a model numerically controlled lathe. But from*

### Neighbourly incompatibility

WE use our BBC Micro with a Philips 14in colour TV using a RGB to Scart lead. As a monitor the TV gives good resolution (80 column mode is quite readable) and we can watch Neighbours!

However, when the BBC Micro is switched on and connected it badly corrupts the TV picture. Most of the time this is not a problem because with the micro switched off the TV behaves perfectly. However if one wants to leave the micro running while watching TV the RGB connector must be unplugged, which is a nuisance.

Is it possible to fit a switch to one of the leads inside the micro which will disable the output to the TV? — **Jim Benn, N Humberside.**

● *I am not sure if you are using the Scart connector circuit I described in the October '90 issue. It sounds as if there is too strong a signal coming from the computer and breaking through the video switch inside the TV set. If you are using this circuit try increasing the value of the series 220R and 270R resistors to 510R. This will reduce the signal and eliminate the breakthrough.*

*If this does not help, it's likely that the Scart socket is not terminated inside. Try replacing the original resistors and put a 75R resistors from the inputs to earth.*





what I can remember it would only cut styrofoam plastic and it was expensive.

There is one in the Philip Harris catalogue (0543 480077) it is a three axis CNC machine at £1,626.46 + VAT. The catalogue entry does not make it clear what type of material it will cut or how accurate it is. The control software package for a Model B is a further £114.02

## X is the key

I OWN a Master Compact and recently the X key stopped working. I have taken the lid off the computer, but could not see anything wrong.

Please could you tell me how to assign the X key to one of the function keys. – **Jonathon Baker, Portsmouth.**

● The X key is on the bottom row and it is possible that a screw close to it has worked loose and dirt has got in. It should be possible to clean this out by using a can of compressed air or electronic cleaning solvent.

However if this fails you can program a function key by:

```
OSCLI("KEYD X")
```

## Ignored sockets

WITH reference to Body Building I<sup>2</sup>C bus in the May, June and July issues of *The Micro User* no mention has been made of sockets eight and nine on the A3000 as a source of the signals and supplies.

SK9	pin1	0V
	pin5	+5V
SK8	pin1	C(0)
	pin2	C(1)

I believe these sockets were only fitted to models using series 1 PCB.

If boards can be daisy-chained there must be a limit to the number of loads that can be driven without the need to buffer the C(0) and C(1) lines.

There seems to be a discrepancy between the articles that appeared in the June and July issues. The addressing between Figure I 9Xh and 1Xh and the test programs which use 7Xh and 9Xh do not match. Also where is Figure III?

Can the I<sup>2</sup>C bus be addressed over the whole range 00H to FFH, apart from those used internally? If so what



Unfortunately that will only give you upper-case so you should also have:

```
OSCLI("KEY1 x")
```

So you have lower case as well.

## Sounds complicated

I HAVE created a large number of sound samples using Soundsynth from EMR and an Armadillo A448 sampler. I thought their quality was quite good until I started to hear the sounds produced by Tracker modules or similar. These were considerably better.

I am also disappointed with the output from Dreamwave. In my version the files cannot be ported into Soundsynth. I would be most grateful if you could advise me on the following points.

Why is the Soundsynth quality relatively inferior – is it the WFS or fixed sample rate? How can I edit the Tracker-type voice samples and

be able to use them with Rhapsody and Studio24+?

Finally, what is the best source of authentic musical sounds for the Arc? – **R. Davies, Sussex.**

● While the sound tracker uses samples it also uses waveform tables. In general a correctly formed waveform table will give a better "sound" than a sampled sound because the latter inherently contains noise due to the nature of digitising.

Also real sounds tend to have a much wider dynamic range than that given by an 8 bit sample. Waveform tables tend to reduce the dynamic range and always have a full or dynamic sound.

It is difficult to know which out of the many parameters is contributing to your assessment of poor sound.

It is important that any sampled sound is pre-filtered to allow no sig-

nals through to the sampler that are higher than half the sampling rate. If this happens you will get aliasing distortion.

I know of a few commercial programs in the pipeline that will allow you to edit soundtracker type voices. Keep your eyes on the news section.

A good source of musical instrument sounds is a tape from Casio called SK Sampler 100 Sampling Sounds.

It is available from Hal Leonard Publishing Corporation, number HL00175084. You should be able to get it at a good music shop.

## Using a serial printer

I HAVE been given a Qume Sprint 11/55 Plus printer fitted with a Qume Connection RS 232-C Model 1 Version 2 computer interface podule. I should like to use it with a BBC Master. Is it possible? – **D. F. Bates, Dagenham, Essex.**

● This is a serial printer, so consult the Master User guide to find out how to connect such machines up make them work.

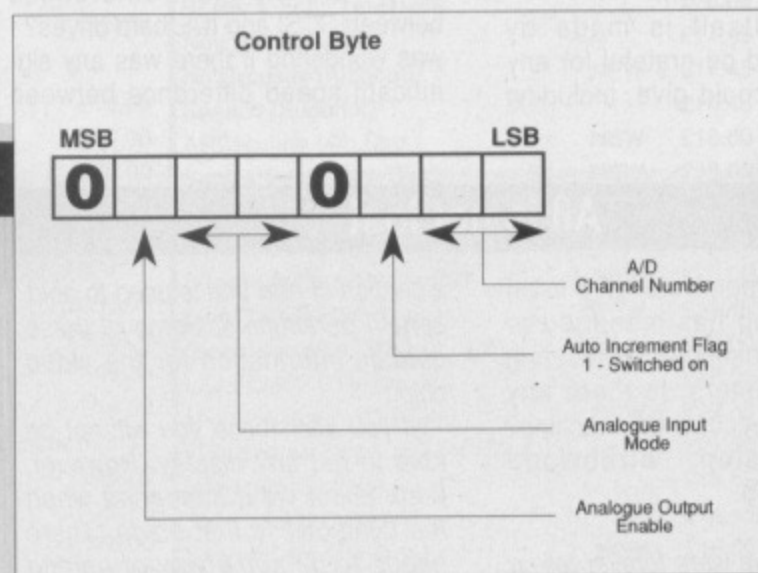

Better late than never, the errant Figure III

Therefore it is not possible to give a simple number of boards driven.

□ The diagram – is correct for the PCF8574A in my kits. This is reflected in the program. Purchasers of the kit get a slip showing the addressing of this chip.

□ Figure III was missing from the June issue. I have had sharp words with the editor, and here it is.

□ The I<sup>2</sup>C can address 128 devices as the least significant part of the address specifies read or write. As you can see from the diagram in the June issue there are parts of the address of any one device that are fixed.

Therefore you can have only

seven different PCF8591 A/D devices and seven each of the PCF8574A digital I/Os. In effect the bus reserves a range of addresses for each device. For further details of devices and their addresses see the Philips Components Technical Handbook 4 Part 12a and 12b.

□ The problem with substituting symbols instead of spaces is that people will try to type them in no matter how many times you tell them not to – we do try to remove multiple spaces.

The listing printer does not use proportional spacing, so you can count the number required using a ruler. However it is rare that this is critical.

# PINEAPPLE SOFTWARE

## The Pineapple Software Real Time Colour Video Digitiser

The Pineapple Software Real Time Colour Video Digitiser is now supplied with not just one, but two fully multitasking application programs! In fact the software supplied with each Digitiser comprises at least four different programs, (the number is increasing all the time). Included in these is the IMICCI application which is probably the most user friendly of all video processing programs. (See photo).

### HARDWARE

The Digitiser hardware consists of a double width podule which plugs straight into the back of a 300 or 400 series Archimedes. (Note that a podule backplane is required in 300 series computers).

For A3000 owners we supply a special inexpensive adapter box which contains the digitiser card and plugs into the back of the A3000 using a ribbon cable.

Inputs are provided for PAL composite video and also R,G,B. Manual adjustment of Contrast, Saturation and Brightness provide for ease of initial setting up.

### SOFTWARE

The Heart of the Digitiser software is a relocatable module which contains all the video processing routines. All of the previously mentioned software applications access these routines in various ways. For the user who can write simple BASIC programs this module provides easy access to all of the Digitiser routines via "\*" commands and SWI's

The new multitasking software makes life very easy for those who wish to incorporate images into Wordprocessing, Desktop publishing, or Art packages. The ease with which grabbed images can be 'zoomed in' and 'cropped' to the required size has to be seen to be believed, and when the required part of the image is selected, it is then a simple matter to 'drag' the image directly into another application.

As well as providing it's own powerful processing routines the Pineapple Digitiser can just as easily use software such as ChangeFSI or AIM to process it's images giving unrivalled versatility.

Also now available in the Multitasking software is a routine to allow capture of a sequence of frames. The number which can be stored depends on the amount of memory you have available (and the size of image chosen), and when grabbed the images can be stored to disc or transferred to PAINT for analysis.

### EXCLUSIVE FEATURES

The Pineapple Software Real Time Colour Digitiser is the only one currently liable with the following exclusive features:-

1. 16 bit operation (extended version) for smoother colour graduations.
2. Two independent multitasking applications plus other powerful software.
3. Digitising of the full video area normally displayed on a TV screen.
4. R,G,B inputs providing higher quality pictures from professional video equipment.

### SPECIFICATION

Video Inputs	Pal coded video. 75 volts - 2.5 volts pk to pk. R,G,B, & sync input All inputs may be terminated by internal DIP switches.
Resolution	512 x 256 pixels
Storage system	Standard version 4 bits Red, 4 bits Green, 4 bits Blue - 192k Ram Extended version 5 bits Red, 6 bits Green, 5 bits Blue - 256k Ram
Picture Area	The Digitiser hardware allows the full screen area normally viewed to be stored in the podule ram. Horizontal shift, Vertical shift and width can be adjusted internally if required.
PAL Decoder	The PAL decoder provides manual control of Brightness, Contrast and Saturation, combined with full auto saturation control.

## PAL COLOUR CODER

A new hardware product now available from Pineapple is a high quality colour coder video unit. This unit produces a full colour coded video signal from the Archimedes computer which enables you to feed the output of the computer into a video recorder or second colour TV monitor.

### FEATURES:-

1. External to computer - no podule slots required.
2. Complete sync pulse regeneration to provide the best possible signal for recording onto VHS recorders or displaying on TV monitors.
3. Switch selectable to 624 or 625 line operation - for interlaced or non-interlaced screen modes.
4. Plugs into R,G,B, computer socket and provides buffered output to feed Archimedes monitor, + coded signal output.
5. Adaptable for use with other computers or R,G,B, and Sync signal sources.

S'VHS Version £79.00

**Price £69.00 + VAT p&p free**

NEW LOW PRICES!!!  
NEW LOW PRICES!!!

## BBC PCB Designer

NEW LOW PRICES!!!  
NEW LOW PRICES!!!

This ever popular Rom based PCB designer is suitable for all BBC micros. It's fast high density 1:1 scale print routine allows prototype boards to be made directly from a printout, and a 2:1 scale print may also be used to produce professional quality boards. A second Eprom is optionally available to add a powerful auto-track routing facility to the program. This utilises a 'rats-nest' input routine and allows any component to be 'picked up' and moved around the board without having to re-specify component interconnection.

The full auto-route facilities are available even on a standard unexpanded model 'B'.  
'PCB Autoroute is remarkable. No similar software comes near the price. *Acorn User* - Aug 88

PRICE	EManual track routing	£55.00	
	Auto track routing	£85.00	
	Plotter Driver	£35.00	P&P free

Still available at new  
discounted price!  
DIAGRAM II £25.00 !!!



!Digi Multitasking Application



IMICCI Application



Butterfly collection

- 'Pineapple has produced one of the 'ultimate' Computer Video Digitisers' -
- 'The Pineapple Colour Digitiser looks to be one of the most professional products yet to be seen on the Archimedes' -  
*Acorn User* - April 90

### Digitiser Prices

Standard	£285.00
Extended	£315.00
A3000 Adaptor Box	£65.00

POSTAGE AND PACKING FREE

## Marconi Tracker Balls

RB2/101	BBC 'B' & 'B+' ...£45.00 inc software	Replacement lead to convert 101 series to Archimedes. £12.50
RB2/101M	Master .....£45.00 inc Pointer Rom	
RB2/115	Archimedes .....£45.00	Postage & Packing on Tracker Balls
RB2/110	Nimbus.....£45.00	£ 1.75

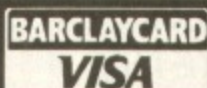

Please add 15% VAT to all prices

39 Brownlea Gardens, Seven Kings, Ilford, Essex IG3 9NL  
Tel: 081-599 1476. Fax: 081-598 2343



**BBC**  
**ACORN USER**  
**SHOW '91**

WEMBLEY CONFERENCE CENTRE - LONDON - 11th to 13th OCTOBER 1991

**THE SHOW**  
**FOR ALL ACORN USERS**

ARCHIMEDES - A3000 - BBC - MASTER - ELECTRON

**\* DON'T MISS \***

**\* OVER 60 LEADING EXHIBITORS \***

- \* LATEST SOFTWARE & HARDWARE
- \* ACORN COMPUTERS FEATURE STAND
- \* COMPUTER PROBLEM 'CLINICS'
- \* FABULOUS GAMES ARCADE
- \* CELEBRITY VISITS
- \* SCHOOLS PROJECTS
- \* INFORMATIVE & ENTERTAINING FEATURES
- \* BBC ACORN USER MAGAZINE EDITOR'S OFFICE
- \* MUCH - MUCH - MORE \*

**ADVANCE DISCOUNT TICKET APPLICATION BBC ACORN USER SHOW '91**

TICKETS AT DOOR - ADULTS £6.00 - UNDER 16's £4.00 - FAMILY TICKETS £16.00 - UNDER 5's FREE

ADULTS £5.00 NAME .....

UNDER 16's £3.00 ADDRESS .....

FAMILY TICKETS £13.00 .....

(2 Adults & 2 Children) .....

..... POSTCODE .....

PLEASE SEND ME ..... ADULT ..... UNDER 16's ..... FAMILY TICKETS

I ENCLOSE A CHEQUE/POSTAL ORDER FOR £..... (MADE OUT TO SAFESELL EXHIBITIONS LTD)

SEND THIS FORM TO ; SAFESELL EXHIBITIONS LTD, MARKET HOUSE, CROSS ROAD,  
TADWORTH, SURREY, KT20 5SR. SHOW INFORMATION WILL BE SENT WITH TICKETS.



FEATURE

**A**s it's only three months to Christmas I'm making my plea for good seasonal PD programs early this year. The BBC PD libraries did an excellent line in carols, but on the graphics and entertainment side there was little beside the superb snowman demo.

Come on guys – I really fancy a tree with candles and a few presents or even a Santa Claus dashing across my icon bar – but not one that wipes my windows.

John Lyons Computer Software got in touch this month with a new multiple choice question program for the BBC Micro. I have come

across this company before in the education market, but this is their first PD outing.

Fidei Defensor is described as a multiple choice quiz for Christians. So racking my brain for what I learnt in confirmation classes, and Bible in hand, I booted up.

There are a number of topics to choose from depending on your age and knowledge. A must for teachers looking to maximise their budget and comply with the religious education part of the National Curriculum, it's also a good test of general and specific knowledge. Added to which, it's very professionally finished and produced.

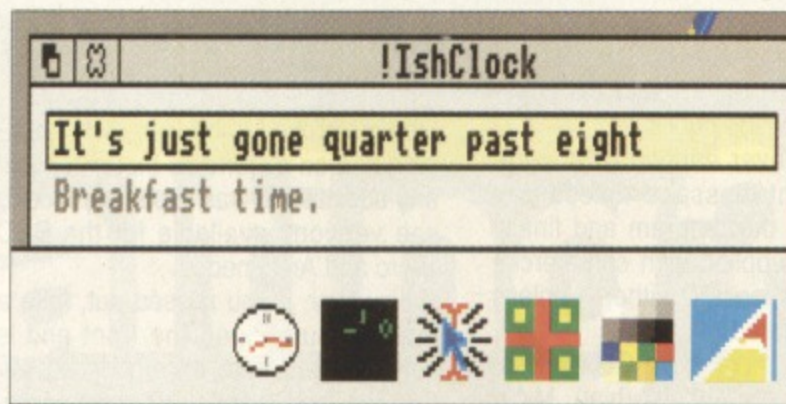

Using the Ishclock

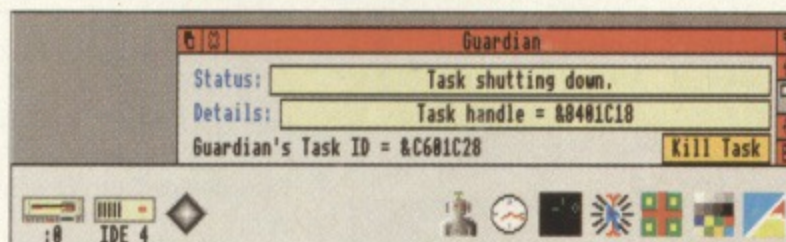

Guardian in action

# PUBLIC

# DE

*Teri Paul samples some of the better offerings arriving on the scene*

# DOMAIN

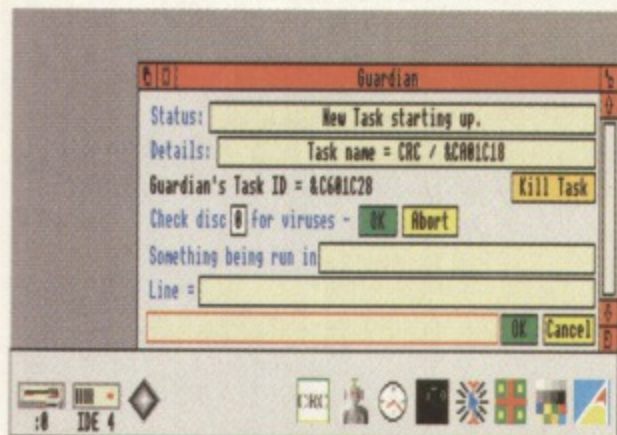

## MemAlloc problems

Every now and again I come across an Archimedes program – usually a game – only to find that it demands MemAlloc to run. Do not despair, for most of you will have this little program hidden on your hard disc or in the depths of your disc box.

The solution is to take MemAlloc out

of Lander – look on Applications Disc 2 – and put it into the modules directory inside !System.

Hard disc users can modify their boot file to load MemAlloc on start-up. However, floppy users could change the !System boot file to load it. The module is quite short, so this shouldn't cause a space problem.

The virus writers have been at it again with a particularly horrid

Archimedes virus called Thanatos – not my idea of fate, I must admit. But the ever vigilant Richard Lloyd's VKiller new version (2.30) deals quite nicely with it and you'll find it on the monthly disc.

Digital Phenomena have also been hard at work on the Guardian virus checker. A nice little icon sits on the icon bar and any time a new application or task is initiated a window opens to tell you what is going on, with the option to kill this task.

The best way to use this – and any well written virus killer – is to include it as part of the start-up sequence. This will ensure that no new application is added without your knowledge and will keep a close eye on what is happening in the background.

A word to the wise, do be careful with virus checking programs. In the PC world some supposed cures have been Trojans, attacking you at a later date. So as a general rule only take virus checkers from reputable outlets and preferably those which contain

the source code so you can see what is happening. It's a good way to improve your programming skills too.

Should you suspect a !Boot file and don't want to delete it you could pop it into !Edit for a quick check. A very simple way to do so is by using a program called !CRC – cyclic redundancy check. You can calculate your file CRC values and if any become suspect you can recheck them – a difference could mean trouble.

Actually the real purpose of !CRC is to help you download files from bulletin boards, and Micronet in particular. The process can often add bytes to the length of the program and !CRC lets you alter it, so disposing of spurious bytes added to the end of files.

As with most of Paul Vigay's programs, he retains copyright and only allows distribution with his permission. As always, if in doubt check.

While we are on the subject of copyright here are a few ground rules. Programs printed in or distributed with



The menu program



magazines are *not* PD and the copyright is held by the publisher.

You are never entitled to change the copyright message unless you have written the program and finally demo files supplied with commercial programs are not PD either – unless specifically stated.

So, for example, Mike Cook's fractal programs are not PD (hint), Micro User games are not PD (hint hint), 4Mation's fonts are not PD (very heavy hint). Any PD library distributing these and similar material is liable to receive a severe shock. 'Nuff said.

### A fistful of utilities

Staying with the Archimedes and Digital Phenomena, they have a couple of fun and useful bits and pieces. In particular the **Ishclock** was a nice development on an earlier timepiece featured in these pages. Not only does it give you approximate times but humorous comments too.

**Dy-Stort** is a fun, if sick, bit of nonsense which melts your DeskTop but you can still work – a multi-tasking version of the earlier Swallow. The **ZoomerBox** is a nice feature, permitting windows to zoom in and out as they open and close.

If you are an Archimedes owner hankering for the days of menu-driven programs why not opt for **Menu?** It provides you with a BBC-style menu system where you can choose by mouse or spacebar the program you next want to see.

In need of a few sounds to enliven your programs? Then look out for boing-up, choke, pop-echo, slide and whoosh. These five sounds are provided as ready to use modules.

You can listen to these off the peg sounds by simply loading them followed by **Sound Player**. Check out some of the rather nice eight and six channel Trackers which are available – they are of a higher quality than the ported four channel SoundTrackers.

Fed up with a menu bar at the bottom of the screen? Well **!NewBar** will allow you to put the icon bar into a window and place it anywhere you want.

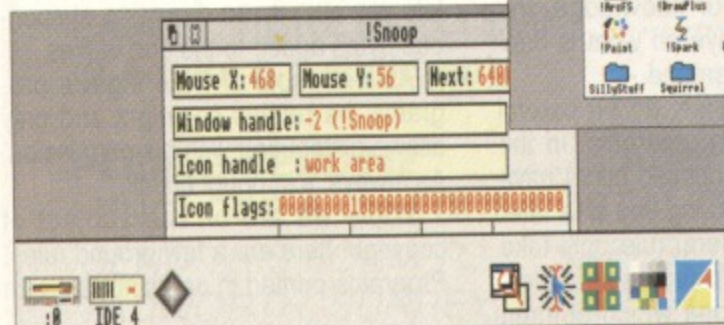

Snooping about

### Have a break

Pipeline proved to be extremely popular game on all formats though simple and addictive. It was especially nice to see versions available for the BBC Micro and Archimedes.

However, if you missed out, take a look at **!BurstPipe**. The front end is very different, with an arcade adventure feel and a series of doors representing the levels to choose from. I did find the lack of instructions – even on which keys to use – a little off-putting. However, if you like Tetris and even if you have already mastered Pipeline you'll probably still appreciate this.

**PV-Life**, on the other hand, is a game which sits happily on the icon bar working out the generations as you continue to work. Truly multi-tasking, you can enlarge the process by accessing the Edit option.

By selecting your own pattern of cells starting with a specific number of cells or preferring a random selection you can see life being created.

### Fractal power

Version 2.0 of **FracTrace** appeared on my desk this month too. Written by Carl Declerk from Belgium, this displays fractal sets by simple raytracing – sometimes referred to as *ray-caching*.

There is an auto-parse option which allows FTS files to be parsed immediately as they are dragged into the program. For those not in the know, an FTS file is an Ascii or text file, and as long as these are not more than 4000 bytes long they can be loaded using configured settings and parsed.

But it's the multi-tasking element which is truly impressive. Fascinating though fractals are, they can take hours and hog a machine unnecessarily, so this one will work in the background.

There is a de-select multitask option provided – though this does take over the whole machine but the calculations are faster.

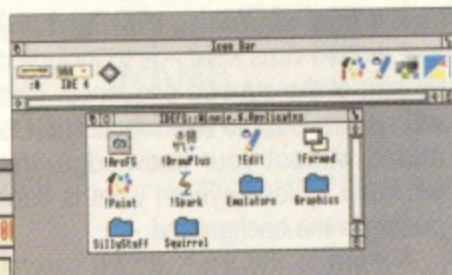

Moveable icon bar

# PD LIBRARIES

Do remember to always send a SAE when you write to any of the PD libraries – they can keep their costs down only if you help, too.

#### Abyss Software - Archi

35 Grantley Crescent  
Kingswinford  
Valley Fields  
West Midlands  
DY6 9EH

#### Arch PD - Archi

190 Ferry Road  
Hullbridge  
Hockley  
Essex  
SS5 6EL

#### BBC PD - BBC

18 Carlton Close  
Blackrod  
Bolton  
BL6 5DL

#### RE Clark PD Library - Archi

Westbourne House  
34 Bradley Street  
Wooton-under-Edge  
GL12 7AR

#### Cotswold PD - BBC

Maycombe  
Field Road  
Whiteshill  
Stroud  
Gloucestershire  
GL6 6AG

#### Cream PD - Archi

38 Baunton  
Cirencester  
Gloscester  
GL7 7BB

#### Digital Illusions - Archi

20 College Road  
Wembley  
Middlesex  
HA9 8RL

#### Digital Phenomena - Archi

104 Manners Road  
Southsea  
Hants  
PO4 0BG

#### Equinox PD - Archi

27 Station Road  
Earls Barton  
Northampton  
NN6 0NT

#### JD Public Domain - Archi

Klembergerweg 7  
7214 BK Epse  
Holland

#### John Lyons Computer Software - BBC

6 Queens Road  
Camberley  
Surrey  
GU15 3BR

#### Mad Rabbit PD - BBC

22 Oakwood Grove  
Horbury  
Near Wakefield  
West Yorkshire  
WF4 5JE

#### Moribund Hedgehog

3 Rodmell Close  
Bromley Cross  
Bolton  
BL7 9DT

#### Ozone Friendly - Archi

180 Cumnor Hill  
Oxford  
OX2 9PJ

#### Robert Pike

4 Mayfield Road  
Girton  
Cambridgeshire  
CB3 0PH

#### PD Magazine - BBC

Computing Department  
Ludlow 6th Form College  
Mill Street  
Ludlow  
Shropshire  
SY8 1BE

#### Re-Run

1 Northolme Close  
Grays  
Essex  
RM16 2NX

#### The Wizard PD

RYBURN  
Thorpe Lane  
Cawood, Selby  
North Yorkshire  
YO8 0SQ



Aleph One Limited

# Still waiting?

Thousands of Aleph One ARM3 Upgrade users don't have to wait – almost every RISC OS application from Impression to Interdictor benefits from the increased speed of Acorn's ARM3 processor.

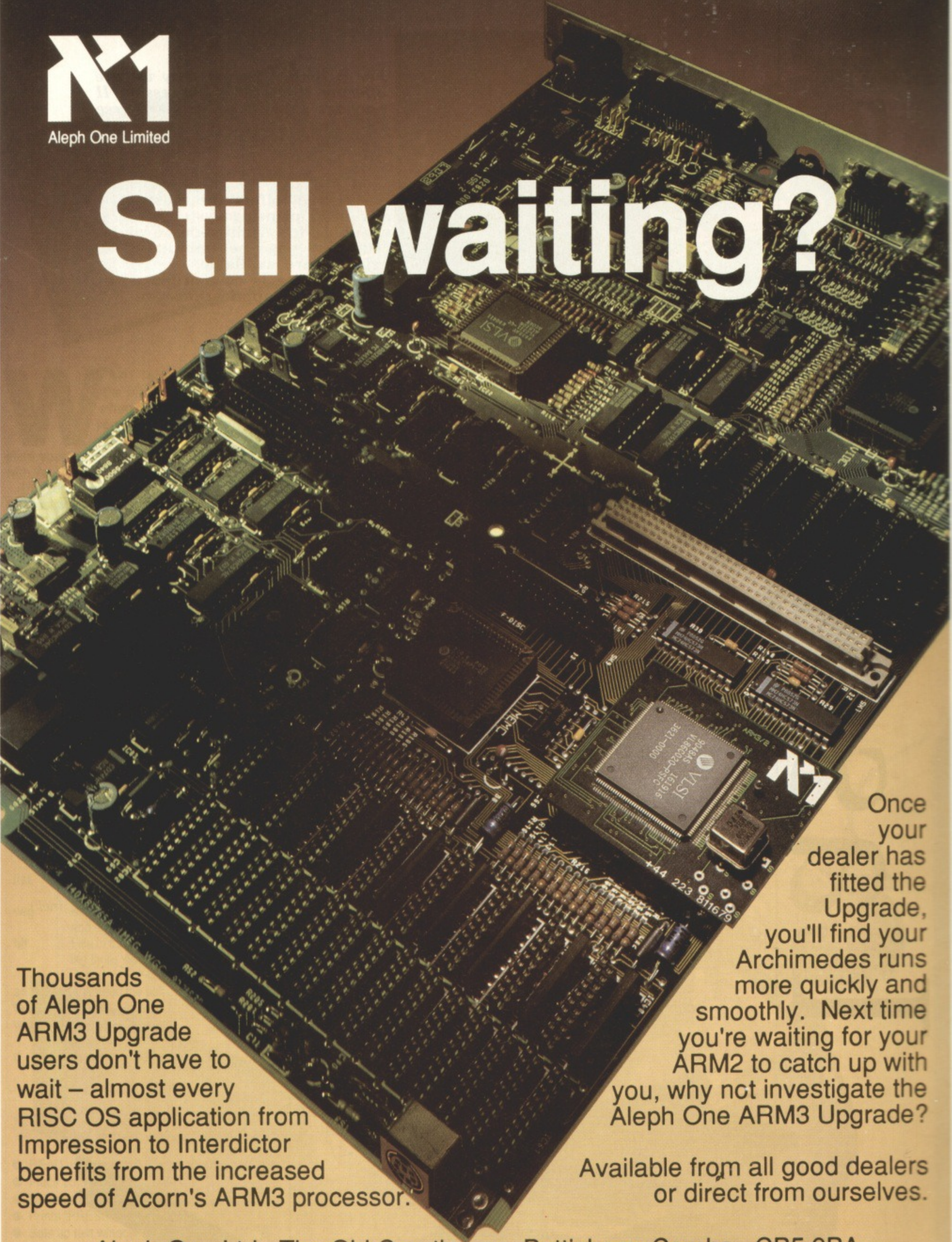

Once your dealer has fitted the Upgrade, you'll find your Archimedes runs more quickly and smoothly. Next time you're waiting for your ARM2 to catch up with you, why not investigate the Aleph One ARM3 Upgrade?

Available from all good dealers or direct from ourselves.

Aleph One Ltd. The Old Courthouse Bottisham Cambs. CB5 9BA  
Tel: (0223) 811 679 - Fax: (0223) 812 713

# LaserDirect

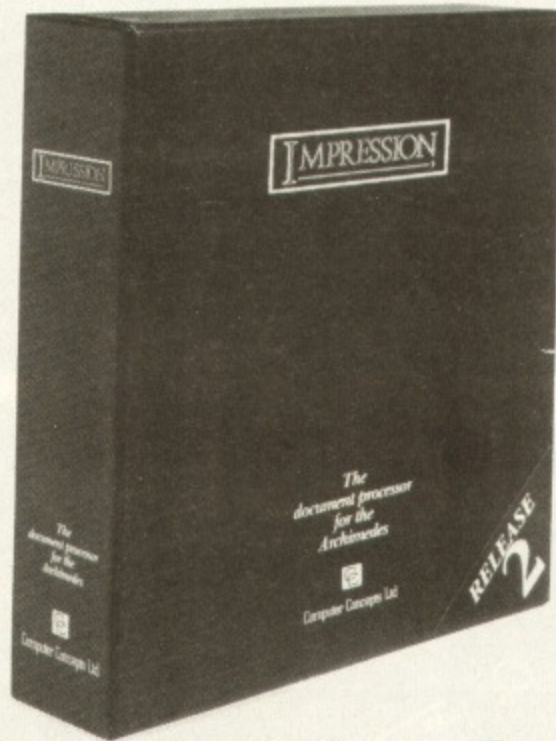

For a limited period only we are offering a complete Impression II package (worth almost £200) free with every LaserDirect or LaserDirect HiRes printer purchased.

LaserDirect offers the most advanced printing system available for Archimedes owners. 300 dpi 6 page per minute printers are available. The software is compatible with all RISC OS applications and outline fonts.

**Background printing • Page compression • Page queueing • FastText mode for outline font printing twice as fast as the next fastest printer • A choice of half-tone settings • Epson LQ emulation for printing from FirstWord, Basic etc. • Educational discounts available**

## Special Offer



LaserDirect 6 pages per minute, £999+VAT (£1173.82 inc.)



Computer Concepts Ltd

Gaddesden Place  
Hemel Hempstead Herts HP2 6EX  
Tel 0442 63933 Fax 0442 231632



LaserDirect HiRes £1495+VAT (£1766.62 incl.)





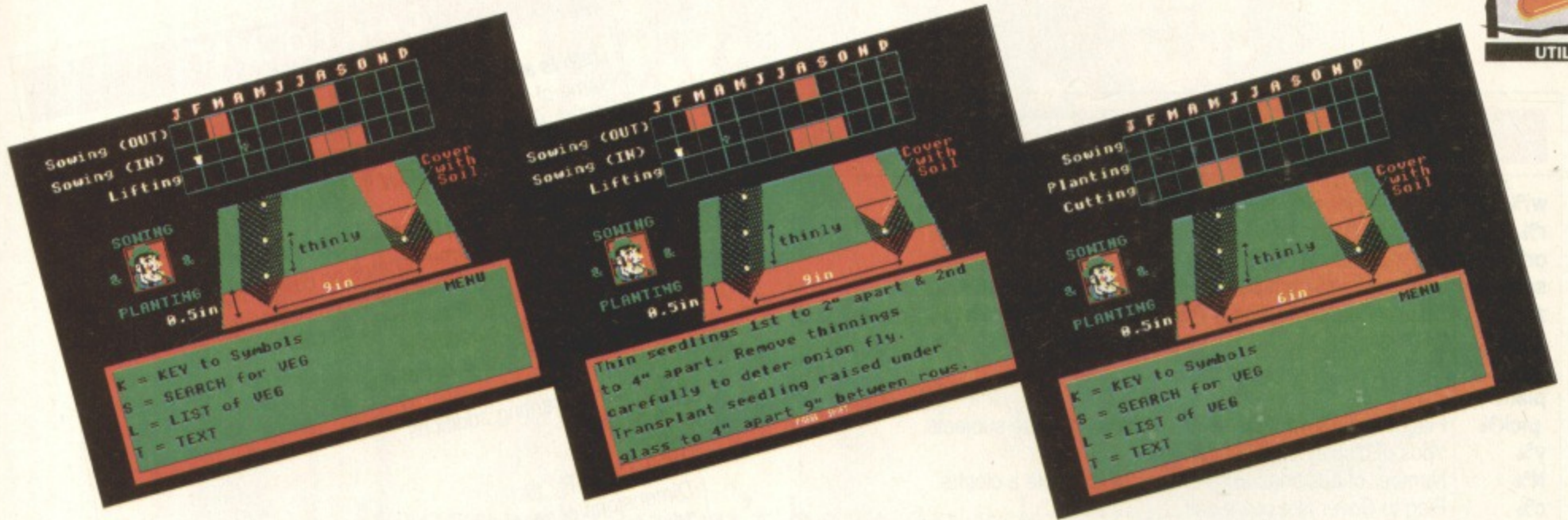

**W**ANT to know at the press of a key when to harvest your haricots, sow your sprouts and plant your parsnips? Now you can with Veg!

This comprehensive guide to 12 of the most popular vegetables tells you all you need to know about sowing, planting and harvesting times, and includes cultivation techniques for maximum yields.

Have a rest from number crunching and try byte-sized carrot crunching – don't be a couch potato, type in and till that soil.

The two listings must be typed in separately. Save the first one as Veg1 and the second as Veg2. To run just CHAIN"Veg1".

# Veg and chips!

*Get down and dig your patch with this cultivation aid by Lea Bason and Mike Goldberg –  
oooooo-aaaarr*



## PROCEDURES

obs	Initialise bits & bobs.
key	Displays what the symbols mean.
menu	The menu.
look	Search DATA for required veg...
list	...and list them on screen.
veg	Draws things to calendar and sowing area.
fill	Fills in the planting/sowing times on the calendar.
sc	Animates the soil cover.
text	Displays the text.
wipe	Removes previous screen data.
d	Draws the dimensions of the seed planting.

## GOSUBS (in order of appearance)

- READ number of times to fill an area and then call PROCfill.
- Place objects on the calendar.
- Redraws sowing area, soil cover seeds etc.
- Prints "PRESS ANY KEY"
- Sets up text window to display KEY



## MAIN VARIABLES

wi%	Wipe flag for old data displayed.
r%	Restore pointer for all data.
or%	Old value of r%.
sort%	Veg type read from data (1=Root, 2=Brassica, 3=Other).
z%	Display flag, 0=Sowing & Planting display, 1=Sowing IN Sowing OUT display.
sow%, plant%, pick%	Flag if any relevant DATA for calendar in these subjects.
y%	Ypos of display on calendar.
N%	Number of additions to calendar, for example a cloche.
c%	Flag to Cover/Not cover soil
name\$	Name of veg
i\$	"in"
PS()	1="PICK", 2="LIFT", 3="CUTT"
sort\$()	1="ROOT", 2="BRASSICA", 3="OTHER"
o\$()	Icons - Cloche, plant pot and so on.
pr\$	"PRESS"
sh\$	"SHIFT"
ak\$	"ANY KEY"
v\$	Name of veg, only first 4 letters of name are required
a\$,b\$,c\$	Planting dimensions.
WS	READ word...
QS	...and then split it up in order that all DATA can be stored any old way but displayed with unbroken words.

## DATA FORMAT

*Data is arranged like this:*

- Name of veg
- Sort of veg (1/2/3)
- Sowing & planting of SOW IN/OUT (0/1)
- Sowing? (0/1)
- Planting? (0/1) PICK(1) LIFT(2) CUTT(3)
- Number of sowing times entries on calendar, X to, X
- Number of planting times entries on calendar, X to, X
- Number of picking times entries on calendar, X to, X
- Number of sowing additions
- Which sort (1=Cloche 2=Pot etc)
- Xpos
- Number of planting additions
- Which sort
- Xpos
- SOIL COVER? (0/1)
- Dimensions of seed planting(X, Y, Z)
- "text", X All text to be finished with an X as a terminator

## NOTES

Veg DATA must be stored at line 5000 onwards with each particular veg separated in steps of 200. The text detailing the veg is the RESTORE number + 100, for example:

```
5200 DATA CARROT,1,0
5300 DATA The carrot is....
```

The last DATA entry must be the word "END" at a line number +200 after the last veg DATA entry.

```
10 REM Veg1
20 REM by Mike Goldberg
30 REM (c) The Micro User
40 MODE1
50 VDU23;8202;0;0;0;
60 PROCinit
70 PROCdcal
80 PROCdsow
90 PROCdtext
100 PROCcoar
110 PAGE=81100
111 CHAIN"VEG2"
120 :
130 DEFPROCinit
140 VDU23,224,0,6,10,18,34,70,74,82
150 VDU23,225,98,66,70,74,82,98,126,0
160 VDU23,226,0,126,126,60,60,60,60,0
170 VDU23,227,24,36,66,153,165,195,153
,165
180 VDU23,228,195,153,219,231,60,24,24
,0
190 VDU23,229,0,24,90,102,60,24,24,0
200 VDU23,230,0,0,24,60,60,24,0,0
210 VDU23,231,16,56,124,16,0,0,0,0
220 VDU23,232,0,0,0,0,8,62,28,8
230 VDU23,233,0,0,32,96,224,96,32,0
240 VDU23,234,0,0,4,6,7,6,4,0
250 VDU23,235,0,0,238,170,236,138,138,
0:VDU23,236,0,0,219,146,219,137,219,0
260 VDU23,237,0,0,106,74,110,42,106,0:
VDU23,238,0,0,183,162,178,162,162,0
270 VDU23,239,0,0,238,170,234,170,170,
0:VDU23,240,0,0,162,162,227,34,226,0:VDU
23,241,0,0,181,165,55,161,183,0
280 s$=CHR$230
290 u$=CHR$231
300 d$=CHR$232
310 l$=CHR$233
320 r$=CHR$234
330 AS="J F M A M J J A S O N D"
340 VDU19,2,2;0;
350 ENDPROC
360 :
370 DEFPROCdcal
```

```
380 GCOL0,2
390 FORJX=736T0928STEP64
400 MOVE384,JX
410 PLOT1,768,0
420 NEXT
430 FORIX=384T01152STEP64
440 MOVEIX,736
450 PLOT1,0,192
```



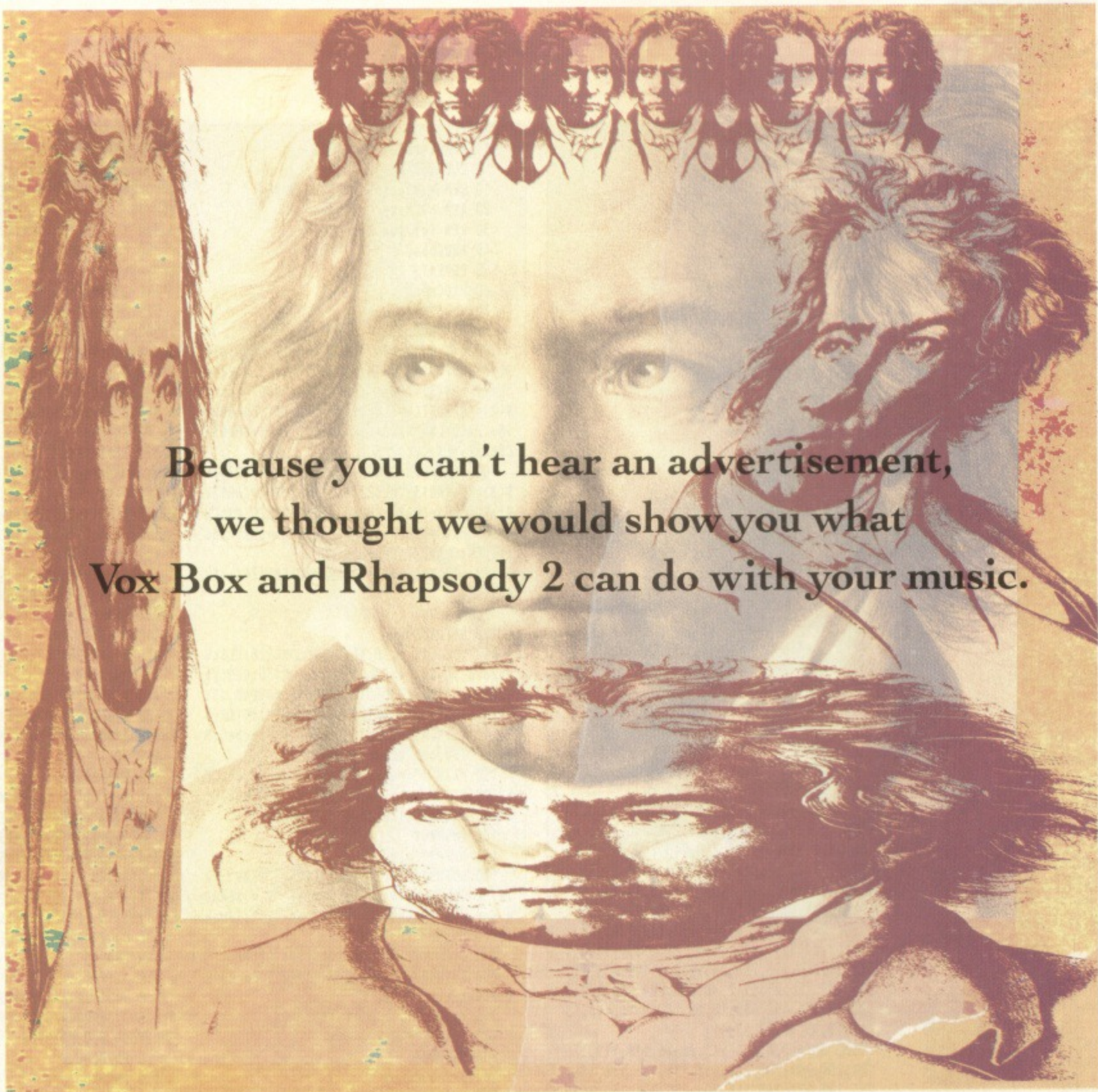

Because you can't hear an advertisement,  
we thought we would show you what  
**Vox Box and Rhapsody 2** can do with your music.

Vox Box and Rhapsody 2 really can enhance your music making. Rhapsody 2 is an improvement on the already successful Rhapsody music notation package. So, now you can do more than ever before. You can drag notes on to the score, transcribe triplets, capture notes in step time and effect MIDI program changes at the beginning or in the middle of a score. Just a few of the new and improved features that you'll discover.

Add to all that the Vox Box symphony of programs, a suite of four programs designed to compliment Rhapsody. There's Perform, which enables the user to play Rhapsody and MIDI files without the need to have Rhapsody present. Then there's Vox Beat which is primarily designed to provide facilities for a drum kit, providing a realistic accompaniment to a score. Vox Sample allows the user to convert sound samples from packages like Armadeus into useable Archimedes voices while Vox Synth will allow you to create

Archimedes voices using digital synthesis.

What is more, Vox Synth allows waveforms to be drawn by hand. This means you can transform an existing piece of music into something completely different. Take a Beethoven Symphony, as the illustration suggests, you really can bend it, shape it, any way you want it.

All of this is simply the tip of the iceberg. Hopefully enough to whet your appetite.

So, please write to the address below for your Vox Box and Rhapsody 2 fact pack. It's certain to be music to your ears.

**Rhapsody 2 – £61.95 inc. Vat**

*To upgrade from Rhapsody to Rhapsody 2 send us your original disc plus £15.50*

**Vox Box – £61.95 inc. Vat**

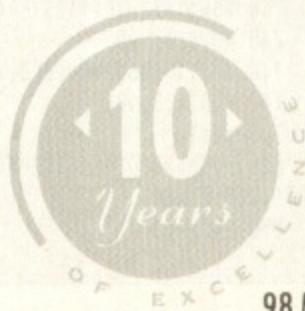

98 Middlewich Road, Rudheath, Northwich, CHESHIRE CW9 7DA. Telephone: 0606 48511 Fax No: 0606 48512



UTILITY

```

460 NEXT
470 PRINTTAB(6,3)"Sowing"
480 PRINTTAB(4,5)"Planting"
490 PRINTTAB(5,7)"Picking"
500 VDU5
510 GCOL0,1:MOVE400,964:PRINTAS
520 GCOL0,3:MOVE404,968:PRINTAS
530 VDU4
540 COLOUR0:COLOUR130
550 PRINTTAB(27,0)"CALENDAR"
560 COLOUR128
570 ENDPROC
580 :
590 DEFPROCdsow
600 VDU5
610 GCOL0,2
620 MOVE384,352
630 PLOT1,80,320
640 PLOT1,608,0
650 PLOT1,80,-320
660 FORIX=448TO668STEP4:PLOT77,704,IX:
NEXT
670 GCOL0,1:FORIX=352TO448STEP4:PLOT77,704,IX:NEXT
680 REMVDU24,384;448;1152;672;
690 VDU24,384;352;1152;672;
700 GCOL0,0
710 XX=544
720 aX=64
730 FORJX=736TO448STEP-8
740 MOVEXX,JX
750 PLOT1,aX,-aX
760 PLOT1,aX,aX
770 MOVEXX,JX-4
780 PLOT1,aX,-aX
790 MOVE1536-XX,JX
800 PLOT1,-aX,-aX:PLOT1,-aX,aX
810 MOVE1536-XX,JX-4:PLOT1,-aX,-aX
820 XX=XX-2
830 NEXT
840 :
850 GCOL0,3
860 IX=584
870 FORJX=668TO476STEP-96
880 MOVEIX,JX:PRINTS$
890 MOVE1502-IX,JX:PRINTS$
900 IX=IX-24
910 NEXT
920 VDU26
930 GCOL0,0
940 MOVE544,384
950 PRINTL$
960 MOVE544,368
970 PLOT1,448,0
980 MOVE976,384

```

```

990 PRINTr$
1000 MOVE440,380
1010 PLOT1,0,64
1020 MOVE424,400
1030 PRINTd$
1040 MOVE428,448
1050 PRINTu$
1060 MOVE632,456:DRAW652,552
1070 MOVE616,480:PRINTd$
1080 MOVE640,560:PRINTu$
1090 VDU4:COLOUR2
1100 PRINTTAB(4,11)"SOWING"TAB(3,14)"&"
TAB(3,17)"PLANTING"
1102 PRINTTAB(10,14)"&"
1110 ENDPROC
1120 :
1130 DEFPROCdtext:VDU4
1140 VDU24,12;0;1264;332;
1150 GCOL0,129:CLG
1160 VDU28,1,30,38,22
1170 COLOUR128:CLS
1180 VDU26
1190 ENDPROC
1200 :
1210 DEFPROCcoar
1220 XX=850DD-640
1230 FORJX=OT03
1240 FORIX=OT063
1250 READaX
1260 ?(XX+(JX*640)+IX)=AX
1270 NEXT
1280 NEXT
1290 ENDPROC
1300 DATA15,8,11,11,11,11,11,26,15,0,30,60,60,120,56,240,15,120,240,240,240,240,240,128,15,240,240,240,240,240,0,15,128,225,225,240,224,240,48,15,0,15,15,15,15,195,240,15,0,15,15,15,15,15,15,15,15,13,13,13,13,13,13,56,120,120,120,120,1310 DATA56,11,10,224,192,192,128,128,179,102,85,0,51,51,119,51,187,153,153,0,136,255,204,136,238,255,223,0,102,238,51,221,255,255,255,112,48,252,204,136,204,239,255,135,195,195,15,15,15,15,143,13,13,13,13,13,13,11
1320 DATA10,8,8,11,11,26,26,119,119,17,128,209,209,209,209,153,136,136,136,136,255,187,187,143,143,206,255,255,255,255,238,187,187,119,119,51,0,187,255,255,187,239,239,1,231,115,185,207,207,15,15,15,15,143,143,13,13,13,13,13,13,13
1330 DATA26,24,88,88,120,120,120,15,209,209,192,224,240,112,128,15,221,238,238,51,0,224,112,15,255,255,51,0,0,16,16,15,119,255,255,255,0,208,176,15,220,238,238,205,3,225,240,15,143,195,56,88,40,28,0,15,13,13,13,133,193,65,73,15,0

```

```

1 IFPAGE<>8E0GOTO32000
2 CLEAR:78E04=244
10 REM > <BasicSave$Dir>.Veg2
20 REM by Mike Goldberg
30 REM (c) The Micro User
40 PROCobs
50 REPEAT
60 PROCmenu
70 UNTILO
80 DEFPROCobs
90 wiX=0:name$="":i$="in":rX=4800:DIM
PS(3),sort$(3),oS(4):PS(1)="Pick":PS(2)="Lift":PS(3)="Cutt":sort$(1)="ROOT":sort$(2)="BRASSICA":sort$(3)="OTHER":KS=CHRS18+CHRS0:LS=CHRS8+CHRS10:oS(1)=KS+CHRS3+CHRS224+LS+CHRS225
100 oS(2)=KS+CHRS3+CHRS32+LS+CHRS226:oS(3)=KS+CHRS3+CHRS227+LS+KS+CHRS2+CHRS228:oS(4)=KS+CHRS2+CHRS32+LS+CHRS229:KS=CHRS18+CHRS3+CHRS2:pr$=KS+CHRS235+CHRS236:sh$=KS+CHRS237+CHRS238
110 ak$=KS+CHRS239+CHRS240+CHRS241:s$=CHRS230
120 ENDPROC
130 DEFPROCkey
140 VDU4,28,1,30,38,22:COLOUR128:CLS:VDU28,3,30,38,22:COLOUR0:COLOUR130:CLS:VDU5:JX=1:FORIX=320TO128STEP-64:MOVE48,IX:PRINToS(JX):JX=JX+1:NEXT:VDU4:PRINTTAB(3,2)"KEY":PRINT"Outdoors under a Cloche":PRINT"Indoors under glass"
150 PRINT"Transplant seedling + CLOCH E":PRINT"Transplant seedling":GOSUB860:VDU4,26:COLOUR128:G=GET:GOSUB860
160 ENDPROC
170 DEFPROCmenu
180 GOSUB870:CLS:PRINTTAB(32)"MENU":PRINT"K = KEY to Symbols":PRINT"S = SEARCH for VEG":PRINT"L = LIST of VEG":IFname$<>"PRINT" T = TEXT"
190 G=GET:IFINKEY-87PROCLIST:ENDPROC
200 IFINKEY-36ANDname$<>"RESTORErX+100:PROCtext:ENDPROC
210 IFINKEY-71PROCKEY:ENDPROC
220 IFINKEY-82PROCKEY:ENDPROC
230 ENDPROC
240 DEFPROClook
250 CLS:INPUT"Which veg? "v$:rX=4800:v$=LEFT$(v$,4):REPEAT:rX=rX+200:RESTORErX:READname$:UNTILLEFT$(name$,4)=v$ORname$="END"
260 IFname$="END"PRINT"No record!":GOSUB860:G=GET:GOSUB860:name$="":ENDPROC
270 IFwiX=1PROCWipe
280 RESTORErX:PROCVeg
290 ENDPROC

```

```

300 DEFPROCLIST:CLS
310 orX=rX:rX=4800:tX=0:REPEAT:tX=tX+1:rX=rX+200:RESTORErX:READf$:IFf$<>"END"PRINTf$;";";
320 IF(tXMOD3)=0PRINT'
330 UNTILf$="END":GOSUB860:G=GET:GOSUB860:rX=orX
340 ENDPROC
350 DEFPROCveg
360 wiX=1:VDU4,26:READname$,sort$,z$:COLOUR3:COLOUR129:PRINTTAB(0,0)name$;";";:COLOUR1:COLOUR131:PRINT;sort$(sort$):COLOUR3:COLOUR128:PRINTTAB(0,3)SPC12TAB(0,5)SPC12:IFzX=0PRINTTAB(6,3)"Sowing"TAB(4,5)"Planting"
370 IFzX=1PRINTTAB(0,5)"Sowing (IN)"B(0,3)"Sowing (OUT)"
380 READsowX,plantX,pickX:COLOUR3:COLOUR128:PRINTTAB(5,7)PS(pickX)
390 IFsowX>0yX=868:GOSUB820
400 IFplantX>0yX=804:GOSUB820
410 IFpickX>0yX=740:GOSUB820
420 VDU5:yX=928:READNX:IFNX>0GOSUB830
430 yX=864:READNX:IFNX>0GOSUB830
440 READcX:IFcX=1PROCCsc(1,1,0)
450 READa$,b$,c$:PROCD
460 ENDPROC
470 DEFPROCFILL
480 GCOL0,1:FORJX=sXTOtXSTEP4:MOVEJX,yX:IF(JXMOD64)<>0PLOT1,0,56
490 NEXT
500 ENDPROC
510 DEFPROCCsc(kX,lX,mX)
520 VDU4:COLOURLX:PRINTTAB(34,11)"Cover"TAB(35,12)"with"TAB(35,13)"Soil":GCOL0,kX:XX=880:FORJX=672TO544STEP-4:MOVEXX,JX:PLOT1,128,0:XX=XX+1:NEXT:GCOL0,mX:MOVEXX,JX+4:PLOT1,128,0:GCOL0,kX:MOVEXX,JX:PLOT1,64,-64:PLOT81,64,64:GCOL3,2
530 MOVE1112,632:PLOT1,-128,-128
540 ENDPROC
550 DEFPROCD
560 VDU5:GCOL3,2:MOVE704,400:PRINTa$;i$:GCOL3,3:MOVE228,424:PRINTb$;i$:GCOL3,2:MOVE664,520:PRINTc$
570 ENDPROC
580 DEFPROCtext
590 VDU5:MOVE576,32:PRINTpr$;" ";sh$:GOSUB870:CLS:VDU14
600 REPEAT
610 READw$:IFw$="X"GOTO680
620 LX=LENw$
630 FORIX=1TOLX
640 qS=MID$(w$,IX,1)
650 IFqS=" "qX=INSTR(w$,qS,IX+1):VX=qX-IX:IFPOS+VX>=38PRINT':GOTO670
660 IFqS=" "qS=CHRS34:PRINT;qS;:ELSEPRINT;MID$(w$,IX,1);
670 NEXT:PRINT'
680 UNTILw$="X":VDU15,5:MOVE576,32:PRINTpr$;" ";sh$:*FX15
690 GOSUB860:G=GET:GOSUB860
700 ENDPROC
710 DEFPROCWipe
720 VDU4,28,1,30,38,22:COLOUR130:CLS:VDU26:COLOUR128
730 IFcX=1PROCCsc(2,0,2):GOSUB840
740 PROCD:VDU4:PRINTTAB(0,0)SPC26:GCOL0,0
750 FORIX=384TO1152STEP4
760 MOVEIX,740
770 IF(IXMOD64)=0GCOL0,2:ELSEGCOL0,0
780 PLOT1,0,184
790 NEXT
800 FORJX=800TO864STEP64:MOVE384,JX:PL0T1,768,0:NEXT
810 ENDPROC

```



10 = 0 0	180 = 657D D	360 = 9719 1	540 = 1429 0	720 = 6696 8	900 = 3AEF 4
20 = 0 0	190 = 96CB 9	370 = 550B 0	550 = 4299 0	730 = 9C3B 5	910 = 2C83 8
30 = 0 0	200 = 60AA D	380 = 334C 7	560 = A76B 9	740 = 79A8 B	920 = B962 9
40 = EA3A A	210 = EB5 6	390 = CC43 8	570 = EDOF 5	750 = E897 C	930 = 130E F
50 = F716 4	220 = AC5F A	400 = 2658 7	580 = 9719 7	760 = 1577 5	940 = F303 9
60 = DEBB E	230 = FAD E	410 = EB1C C	590 = 963D A	770 = 804E 7	950 = FEC3 4
70 = BFFC 9	240 = 1418 3	420 = 2C83 5	600 = 667A 2	780 = E897 5	960 = 1180 9
80 = 7CCA C	250 = 6772 6	430 = 1920 9	610 = 334C B	790 = 21E5 0	970 = E8A6 C
90 = CDDA 8	260 = 9756 B	440 = 7D83 A	620 = 4F5F 2	800 = A0BD E	980 = 2B0B 3
100 = 277D 7	270 = A860 7	450 = B091 F	630 = B6F6 7	810 = BB92 5	990 = DEBF 6
110 = 7E9E F	280 = 47D9 D	460 = 2C83 F	640 = 66D4 C	820 = D9C2 4	1000 = 82E0 4
111 = 13E6 4	290 = F6DD 0	470 = 806D 1	650 = EFE1 5	830 = 2C83 5	1010 = C081 5
120 = 9719 1	300 = 49A4 8	480 = FEBE D	660 = CDB8 A	840 = 9719 F	1020 = 8A3E E
130 = 344C 2	310 = CA28 9	490 = 6A39 B	670 = F2F7 E	850 = 236D D	1030 = 776A D
140 = 7AF0 7	320 = BF3C A	500 = 667A 9	680 = 0 E	860 = C8C0 E	1040 = 4CD9 4
150 = 1B6A A	330 = 5332 3	510 = 522 A	690 = B159 E	870 = 7497 4	1050 = 4728 5
160 = DE68 6	340 = 94D0 A	520 = E424 8	700 = 130E 8	880 = B42E F	1060 = 509 3
170 = D837 D	350 = EDOF F	530 = 765B 6	710 = D289 E	890 = 4FF2 9	1070 = 8246 E

```

820 READN%:FORIX=1TON%:READS%,f%:PROCF
ill:NEXT:RETURN
830 FORIX=1TON%:READO%,x%:MOVEX%,y%:PR
INTO$(O%):NEXT:RETURN
840 VDU24,384;352;1152;672;:GCOLO,0:XX
=544:a%=64:FORJX=736TO544STEP-8:MOVE1536
-X%,JX:PLOT1,-a%,-a%:PLOT1,-a%,a%:MOVE15
36-XX,JX-4:PLOT1,-a%,-a%:XX=XX-2:NEXT:VD
U26
850 VDU5:GCOLO,3:IX=918:FORJX=668TO476
STEP-96:MOVEIX,JX:PRINTS$:IX=IX+24:NEXT:
RETURN
860 VDU5:MOVE576,32:PRINTPr$;" ";ak$:R
ETURN
870 VDU4,28,1,30,38,22:COLOURD:COLOUR1
30:RETURN
5000 DATACABBAGE,2,0,1,1,3,1,800,864,1,
928,992,1,576,704,0,0,1,6,0.5,thinly
5100 DATAPlant seedlings 3' apart in ro
ws 15' between rows. Plant firmly & wate
r well. Apply liquid comfrey manure when
heads begin to mature. Earth up stems o
f spring cabbage in autumn.,X
5200 DATACARROT,1,0,1,0,2,1,576,768,1,7
68,1024,1,1,512,0,1,6,0.5,thinly
5300 DATAsoil must be deep & fertile bu
t do not manure beforehand - if your soi
l is heavy grow stump rooted varieties.
Thin carefully in the evenings to deter
carrot fly - planting alternate rows of
onions helps.,X
5400 DATAPOTATO,1,0,0,1,2,1,560,640,1,7
68,960,0,0,1,24,5,12in
5500 DATAWhen plant is 9' high earth up
to 6' high to avoid greening of potatoe
s water in dry weather when tubers begin
to form.,X
5600 DATABROCCOLI,2,0,1,1,3,1,608,672,1
,736,800,2,448,656,832,992,0,0,1,12,0.5,
12in
5700 DATAThin seedlings to prevent weak
plants. 12' between plants & 12' betwee
n rows. Grow in heavily manured soil. Ne
t against pigeons. Feed with liquid manu
re. Broccoli matures the year after plan
ting.,X
5800 DATASPROUT,2,0,1,1,1,1,544,608,1,6
72,736,2,384,496,960,1152,1,1,512,0,1,6,
0.5,thinly
5900 DATAThin seedlings gradually to pre
vent weak growth until plants are 18' ap
art. Main cause of failure is lack of ma
nure & planting in loose soil. Stake pla
nts if necessary to protect from wind an
d earth up as required
5901 DATAfor more stability.,X
6000 DATACAULIFLOWER,2,0,1,1,3,1,576,67
2,1,736,832,1,512,1088,0,0,1,6,0.5,thinl
y
6100 DATAThin seedlings to 3' apart & r
ows 24' apart. Water & feed well - bend
leaves over curds to protect from sun. C
aulis need well compacted soil - heavily
manured - lime if necessary.,X
6200 DATARUNNER BEAN,2,1,1,0,1,1,672,75
2,1,832,992,0,2,2,640,4,704,0,18,2,9in
6300 DATAVery hungry crop needing lots
of manure & liquid feed. Mulch to conser
ve moisture. Remove growing points when
plants reach the top of the supports.,X
6400 DATAONION,3,1,1,0,2,2,496,560,832,
896,1,784,944,0,2,2,432,4,576,1,9,0.5,th
inly
6500 DATAThin seedlings 1st to 2' apart
& 2nd to 4' apart. Remove thinnings car
efully to deter onion fly. Transplant se
edling raised under glass to 4' apart 9'

```

```

between rows. Mulch well to cut down ne
ed for water & feed occasionally.
6501 DATABreak off flower stems which a
ppear - stop watering when onions are sw
ollen.,X
6600 DATALETTUCE,3,0,1,0,3,1,560,800,1,
736,992,2,2,448,3,512,0,1,12,0.5,thinly
6700 DATAlettuce like well manured soil
- non acid & plenty of water. Avoid ove
rcrowding thin as soon as first leaves a
ppear. Lettuces dislike being transplant
ed - sow seed where they are to grow.
6701 DATAWater in the morning to lessen
chances of disease.,X
6800 DATACALABRESE,2,0,1,1,3,1,608,672,
1,736,800,2,448,656,832,992,0,0,1,6,0.5,
thinly
6900 DATAThin seedlings to prevent weak
plants. 12' between plants & 12' betwee
n rows. Grow in heavily manured soil. Ne
t against pigeons. Feed with liquid manu
re. Unlike Broccoli- although the same f
amily- Calabrese matures the same year
6901 DATAas planting.,X
7000 DATALEEK,3,0,1,1,2,1,544,608,1,704
,784,2,384,608,1024,1152,3,2,432,2,448,4
,624,0,1,6,0.5,thinly
7100 DATADig in well rotted manure. Tra
nsplant seedlings when approx 8' high. M
ake 6' holes with dibber - place leek in
& fill with WATER (not soil). Keep well
watered feeding with comfrey liquid man
ure. Generally pest & disease free.,X
7200 DATASWEETCORN,3,1,1,0,1,1,688,704,
1,864,928,1,1,656,2,2,624,4,704,0,18,1,1
8in
7300 DATAPlant 2 seeds in blocks 18' be
tween transplants (not in rows) to aid p
ollination. Water well. Roots will appea
r at bottom of plant - draw earth up to
cover. Plant in full sun to ensure ripe
cobs.,X
7400 DATAEND
32000 *TAPE
32005 FORIX=OTO TOP-PAGE STEP4
32010 IX!&E00=IX!PAGE:NEXT
32015 ?&13=?&13-(PAGE-&E00)DIV256
32020 PAGE=&E00:RUN

```



1 = 38C6 6	320 = AF7C 9	<b>Get it right ✓</b>	650 = EB5 5	5600 = C654 1
2 = 9B60 8	330 = EE5E 7		660 = 997D 7	5700 = AA3F 6
10 = 0 8	340 = EDOF 7	670 = CB7D A	5800 = B6DD 7	
20 = 0 8	350 = E68B 4	680 = CB6E 1	5900 = 40A7 A	
30 = 0 8	360 = 36CB C	690 = AB48 C	5901 = 8EC3 9	
40 = E6C3 5	370 = 5123 9	700 = EDOF C	6000 = 997 9	
50 = BFBA E	380 = 4AE4 E	710 = B3DA B	6100 = 5D69 E	
60 = 6D0D C	390 = 670B F	720 = A58F 7	6200 = 1ADC 5	
70 = 53CE 5	400 = 1676 5	730 = 7F4B 4	6300 = 395F 7	
80 = F05B 6	410 = 77E0 6	740 = 353F A	6400 = CB17 7	
90 = 8B58 8	420 = D246 5	750 = 365F E	6500 = FF1C A	
100 = DE39 E	430 = 8DED 1	760 = 84D2 A	6501 = B91B B	
110 = 6022 5	440 = A949 5	770 = 703F 4	6600 = D8B0 1	
120 = EDOF B	450 = 592D D	780 = EE66 8	6700 = C05E 1	
130 = 1446 1	460 = EDOF 6	790 = 2C83 B	6701 = 27BB B	
140 = B192 F	470 = 9FE 7	800 = 994C 5	6800 = AFF7 2	
150 = DC4F 6	480 = DAC2 A	810 = EDOF 3	6900 = 35FB 6	
160 = EDOF 9	490 = 2C83 8	820 = C08C F	6901 = 1F4D 1	
170 = 87FA C	500 = EDOF 6	830 = 234F 3	7000 = 1674 C	
180 = D393 C	510 = 8C1C E	840 = EACA 7	7100 = CC5 7	
190 = 8D26 5	520 = 76F1 9	850 = 1886 9	7200 = 3403 D	
200 = 7EEA 2	530 = BE81 8	860 = 1DE6 5	7300 = 964A 5	
210 = 3259 6	540 = EDOF 8	870 = C182 4	7400 = 37EF 5	
220 = AE49 5	550 = 7E44 1	5000 = D579 E	32000 = CD93 0	
230 = EDOF 1	560 = 304C E	5100 = E19B 7	32005 = E402 8	
240 = F641 7	570 = EDOF D	5200 = 77AA E	32010 = A774 1	
250 = A6CF A	580 = D6DE F	5300 = DEB5 C	32015 = A805 3	
260 = D30A B	590 = 7430 6	5400 = C25B A	32020 = 7290 2	
270 = 46A 2	600 = BFBA 9	5500 = 2EEE B		
280 = A24D C	610 = F9F6 4			
290 = EDOF 9	620 = 8FBC 1			
300 = 8788 6	630 = 2494 B			
310 = 1842 A	640 = E340 C			

# Archimedes

BASIC COLOUR

A3000...see below...see below...see below		
A410/1	£989.10	£1187.10
A420/1	£1169.10	£1367.10
A440/1	£1529.10	£1727.10
A540	£2695.50	£2893.50

## SUMMER SUPER SPECIALS

**A3000 Basic Model**  
**SUPER Price £499.99#**  
**OR !**  
**A3000 Stereo Colour Model**  
**SUPER Price £695.00#**

**WE ARE OPEN ALL DAY SATURDAY**  
**WHY NOT VISIT OUR SHOWROOM !**  
**TEST FLY INTERDICTOR 2 OR**  
**TEST DRIVE THE NEW A540 ARM3**  
**\*\*\*\*\***

**WE WILL TRY TO BETTER ANY OTHER**  
**DEALER PRICE ... PLEASE TELEPHONE**

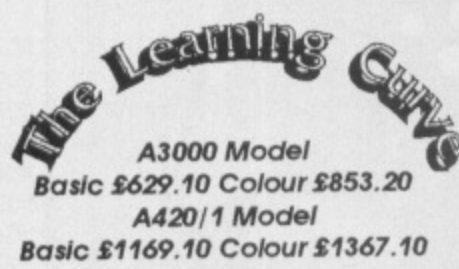

**A3000 Model**  
**Basic £629.10 Colour £853.20**  
**A420/1 Model**  
**Basic £1169.10 Colour £1367.10**

**OUR PRICES**  
**DO NOT**  
**INCLUDE V.A.T.**

Master 128	£359.10
Cambridge Z88 Lap Top	£189.95
Panasonic KX P1081	£146.95
Citizen Swift 9	£157.00
Citizen Swift 24	£260.83
Citizen Swift colour upgrade	£34.20
Star LC10	£155.40
Star LC10 Colour	£294.35
Philips 8833 Colour	£195.00#
Philips 7522 Amber Screen	£69.52
Philips 8832 Colour	£199.67
Ahktek 40/80 400K Sgle no PSU	£99.00
Ahktek 40/80 800K Dual no PSU	£199.00
Ahktek 40/80 400K Sgle & PSU	£114.53
Ahktek 40/80 800K Dual & PSU	£221.70

## OAK COMPUTERS

20 Mb Ext HDisc (B & Master)	£517.75
SCSI 20Mb Add HDisc A3/410	£413.25
SCSI 20Mb Ext HDisc A3000	£508.25
SCSI 45Mb Add HDisc A3/410	£527.25
SCSI 45Mb Ext HDisc A3000	£622.25
SCSI Card for A3000	£189.05
SCSI Card for A3/410	£189.05

**WE ARE LICENSED CREDIT BROKERS AND CAN OFFER**  
**FINANCE ON COMPUTERS AND SOFTWARE. WE OPERATE**  
**THE ACORN TEACHER AND ACADEMIC SCHEMES FOR**  
**TRAINING AND FINANCE. PLEASE TELEPHONE !**



0457 865953 0457 869917

# COMPUTECK Ltd.

**Dinting Lane Industrial Estate**  
**Glossop**  
**Derbyshire SK13 9NU**  
**Visa-Master-Lombard Cards**

### ACORNSOFT

Desk Top Publisher (A)	£119.20
Lisp (BMC)	£16.10
Logistix (A)	£89.10
Micros In Business (BMC)	£34.75
Twin (A)	£26.10
View 3.0 (B)	£41.60
View Index (BMC)	£10.40
View Plot (BMC)	£20.83
View Professional (BMC)	£55.51
View Sheet (BMC)	£41.60

### COMPUTER CONCEPTS

Inter-Base (BMC)	£48.00
Inter-Chart (BMC)	£25.60
Inter-Sheet (BMC)	£39.20
Inter-Word (BMC)	£39.20
Inter-Sheet (A)	£23.20
Inter-Word (A)	£23.20
Laser Direct Laser Printer	£949.05
Spell Master (BMC)	£41.03
Impression II (A)	£152.09
Impression Junior (A)	£80.95

### CLARES MICRO SUPPLIES

Alpha Base (A)	£39.09
Artisan 2 (A)	£46.91
Toolkit (A)	£39.09
Interdictor 2 (A)	£27.35
Knowledge Organiser (A)	£46.91
Fontwise package (BMC)	£23.47

### IMPACT SOFTWARE

The Real McCoy (A) Discs	£23.44
Man at Arms (A)	£15.62
Holed Out (A)	£15.62
Apocalypse (A)	£23.44
Nevryon (A)	£15.62
The Olympics (A)	£15.62

### PRES

Adv. Control Panel (BMC)	£27.90
Adv. Disc Investigator (BMC)	£23.52
Adv. Disc Toolkit (BMC)	£27.90
Adv. File Manager (BMC)	£22.51

**PRES Archi products all discounted !!**

### MINERVA SYSTEMS

System Delta+Card Index (BM)	£50.83
System Delta Plus (A)	£62.56
Ateller (A)	£78.22

### DABS PRESS

Master Guide Book	£11.66
Viewstore/Sheet Book	£11.66
Archimedes DFS Disc	£23.44
"C" A Dabhand Guide	£13.45
Z88 A Dabhand Guide	£13.45
Archimedes Beginners Guide	£8.95

## Summer Clearance

Goupil Golf Laptop/Desk PC 1meg 286	
40meg H/disc VGA ..... Retail £3500.00	
SAVE £2300.00..... <b>SALE Price £1200.00</b>	
Amstrad PC2086HD 12" VGA colour	
30meg H/disc ..... Retail £899.00	
SAVE £200.00 ..... <b>SALE Price £699.00</b>	
Amstrad PC2086SD Mono monitor	
3.5" Floppy Drive ..... Retail £499.00	
SAVE £50.00 ..... <b>SALE Price £449.00</b>	
Western Digital 30meg H/Card	£249.00
SAVE £50.00 ..... <b>SALE Price £199.00</b>	

**This advert contains just a few of the items we have**  
**Please telephone or send a SAE for our FULL price lists**

**PRICES MARKED # ARE CHEQUE**  
**or CASH ONLY NO CREDIT CARDS**

**We specialise in "Trading In" and**  
**buying Used Hardware & Software**

**Post and Packing Charges**  
**£1.00 for small, £2.45 for medium items.**  
**Expensive products £9.00 for courier**

## USED STOCK SELECTION from COMPUTECK Ltd.

### COMPUTERS & HARDWARE

Acorn	A3000 Archimedes Basic	370.00
Acorn	BBC B 1770 DFS Series 3	170.00
Acorn	BBC B 1770 DFS Series 4	170.00
Acorn	BBC B 1770 DFS Series 7	200.00
Acorn	BBC B 8271 DFS Series 3	170.00
Acorn	BBC B 8271 DFS Series 4	170.00
Acorn	BBC B 8271 DFS Series 7	200.00
Acorn	BBC B+128 Computer	256.52
Acorn	Master 128	262.61
Acorn	Master Turbo Board	70.00
Misc.	Z80 Second Processor	90.00
Misc.	Quadium Multiscan 14	225.00
Misc.	Zenith Amber Screen	40.00
Epson	LQ/LX400 Cut Sheet Feeder	50.00
Misc.	Brother HR40 Daisy Wide Carr.	346.96
Misc.	Dual Drive 80T no PSU	120.87
PRES	Hard Disc 20 meg A3000	295.00
Watford	Dual Drive 80T no PSU	120.87
A M S	AMX Mouse	20.00
A M S	Mouse (C)	20.00
Acorn	ADFS ROM and Disc	15.00
Acorn	Master Econet Module	30.00
Acorn	Priestel Adaptor (BM)	40.00
Acorn	Serial Link to BBC (A) Disc	12.00
Beebug	Scanlight Junior (A)	120.00
Comp Con	8K SRAM Module	12.00
Misc.	Chroma 250 Genlock Wild/Vison	295.00
Misc.	Gratpad	60.00
Misc.	Printer Sharer & Comps to 1 Pt	160.00
Misc.	Prism Modem 2000 in Software	60.00
Misc.	Terril printer Sharer Box	23.00
Misc.	Timer Kit	8.00
Misc.	Timewarp RTC Technomatic (B)	13.87
Moiley	3.5	95.00
Nidd Vall	Anamouse (BM)	20.00
PRES	Padule Expansion Box (A)	11.00
PRES	System Housing A3000	49.00
Watford	16K Disc RAM Board (B)	20.00
Watford	Beeb Scanner (BM)	85.00
Watford	Power Duck	6.00

### BOOKS

Acorn	Advanced User Guide BBC	10.00
Misc.	30 Basic Spectrum	3.00
Misc.	30 Hour Basic	4.00
Misc.	Assembly Lang Prog I Binbaum	4.00
Misc.	Century Programming Course	4.00
Misc.	Data Processing/Hardware & Progms	0.00
Misc.	Forth on the BBC Micro	5.00
Misc.	Graphics & Sound by S Money	3.00
Misc.	Inside Information/J Megarry	4.00
Misc.	Into The BBC Micro/1 Sinclair	3.00
Misc.	Little Book of Basic Style	3.00
Misc.	The Computer Book/BBC Publics	3.00

### SERIOUS SOFTWARE

4matlon	Granny's Garden (C) Disc	6.00
A M S	AMX Super Art ROM (B)	25.00
A M S	Extral Extral (BM) Disc	12.00
A M S	Stop Press Discs (M)	25.00
A M S	Super Art (C) Disc	25.00
Acorn	PC Emulator (A) Discs	60.00
Acorn User	Gallery Disc (B) 2xDisc	6.00
Acorn User	User Rom	12.00
Acornsoft	1st Word Plus Rel 2 (A) Disc	43.04
Acornsoft	BCPL ROM (B)	31.31
Acornsoft	Desk Top Publisher (A) Disc	49.00
Acornsoft	Forth (B) Disc	6.00
Acornsoft	GXR Rom (B) ROM/Tape	16.00
Acornsoft	Hi - View (B) Disc	22.00
Acornsoft	Linkword French (BM) Tape	10.00
Acornsoft	Logistix (A) Disc	60.00
Acornsoft	View Spell (BM) ROM & Disc	21.74
Acornsoft	View Store (BMC) ROM	30.00
Acornsoft	Viewsheet (BMC) ROM	30.00
Acornsoft	Workshop (B) Disc	6.00
BBC Pubs	Drawing (B) Tape	3.39
BBC Pubs	VU-Type (B) Tape	6.00
Beebug	Design (B) Disc	10.00
Beebug	DFS Reader (A) Disc	7.00
Beebug	Masterfile II (C) Disc	12.00
Beebug	Paintbox (B) Disc	8.00
Beebug	Quickcalc (B) Disc	8.00
Beebug	Quickcalc (C) Disc	8.00
Beebug	Steuth (B) ROM	18.00
Beebug	Teletext (B) Tape	3.50
Beebug	Teletext Pack (B) Disc	7.00
Beebug	Toolkit Plus (B) ROM	18.00
Beebug	Vocab Tester (B) Tape	8.00
Beebug	Wordbase (B) ROMs	12.00
Beebug	Airroom (C) Disc	15.00
Clares	Airroom (M) Disc	15.00
Clares	Airroom (M) Disc	12.00
Clares	Beta Base Utils (B) Disc	6.00
Clares	Fontwise + (C) Disc	8.70
Clares	Render Bender (A) Disc	39.00
Comp Con	Accelerator (BM) ROMs	28.00
Comp Con	Carietaker (B) ROM	12.00
Comp Con	Graphics (BM) ROM	15.00
Comp Con	Gremiln (B) ROM	15.00
Comp Con	Impression Junior (A) Disc	50.00
Comp Con	Inter-Sheet (BMC) ROM	30.00
Comp Con	Spell Master (A) Disc	20.00
Comp Con	Spell Master (BMC) ROM	30.00
Comp Con	Wordwise Plus (BM) ROM	26.09
Minerva	Gamma Plot (A) Disc	40.00
Minerva	Home Accounts (A) Disc	25.00
Minerva	Inter/View Link (C) Disc	10.00
Minerva	Mail Shot Application (C) Disc	10.00
Minerva	Sales Ledger (BM) Disc	26.04
Minerva	Stock Management (C) Disc	26.04
Misc.	1st Word Study Guide (A) Disc	10.00
Misc.	3D Logo (C) Disc	12.00
Misc.	ADE+ (M) 2xROM	30.00
Misc.	AIDS II by Soft Smith	8.65
Misc.	Archway (A) Disc	60.00
Misc.	Bert Bool Maths 8-12 (C) Disc	10.00
Misc.	Basicalc (BM) Disc/Supersoft	8.65
Misc.	Control Logo (C) Disc	12.00
Misc.	Creation Discs (A) EMR 6xDiscs	26.04
Misc.	Deebug and Disk Copy (B) Disc	8.26
Misc.	Dlogram (B) Disc Pineapple	21.70
Misc.	Draw Bender (A) Disc	8.00

Misc.	Fontald (B) ROM & Disc CJE	15.00
Misc.	Gemini Combo Pack (B) Disc	12.00
Misc.	Graphics Pack (B) Tape Salaman	3.00
Misc.	Icon Art Master (BM) Disc	12.00
Misc.	Instant Recall D/base (B) tape	6.00
Misc.	Invoicing (B) Disc	10.00
Misc.	Logo Extension (C) Disc	7.78
Misc.	Maths Age 4-14 (C) Disc	15.00
Misc.	Meilin Database/Scribe (B) ROM	17.34
Misc.	Micro Maths GCSE (C) Disc	15.00
Misc.	Morse Tutor (B) Disc	8.65
Misc.	Music Logo (C) Disc	12.00
Misc.	Personal Accounts (A) Disc	17.00
Misc.	Pixel Perfect DTP (BM) Discs	26.04
Misc.	Pixel Perfect Maths Pack (B)	10.00
Misc.	Pro Punter (BM) Discs	30.00
Misc.	Record Keeper (B) Tape	4.00
Misc.	Science & Technology (B) Disc	12.00
Misc.	Share Anal-Synergy (B) Disc	26.04
Misc.	Slave + ROM (B)	20.00
Misc.	Spanish level A (BM) Disc	10.00
Misc.	Spanish level B (BM) Disc	10.00
Misc.	Spy (B) ROM	12.00
Misc.	Star Stick (B) ROM	10.00
Misc.	Superboal (BM) Disc	6.00
Misc.	Ulliram (B) Disc by Tubelink	10.00
Misc.	Vilifax-Viewdata (B) ROM	20.00
Misc.	Vu-Calc (Psion) (B) Tape	8.00
Misc.	VU-File (B) Tape	10.00
Misc.	Xmas Carols (A) EMR Disc	4.30
Misc.	ZOOM Mach. Code Monitor (B)	10.00
Oak	Parametric Design Tool (A)	169.57
P M S	The Publisher (C) ROM + fonts	29.95
Pace	Micronet Terminal (B) ROM	8.00
PRES	Advnc'd 1770 DFS (B) ROM	20.00
Superior	Speech1 (BM) Disc	6.00
Watford	Beebmon (B) ROM	20.00
Watford	Colour Art (B) Disc	6.00
Watford	NLQ Designer (BM) ROM	12.00
Watford	Office Master (B) Disc	10.00
Watford	Office Mate (B) Disc	6.00
Watford	View Printer Driver ROM	25.00
Watford	Wapping Editor (BM) ROM	30.00

### GAMES

Acornsoft	Hills Vol 1 (C) Disc	7.00
Acornsoft	Hills Vol 2 (C) Disc	7.00
Acornsoft	Me & My Micra (E) Tape 8 Games	1.50
Acornsoft	Rocket Rold (B) Tape	2.00
CDS	Colossus Chess (BM) Disc	6.00
Clares	Interdictor (A) Disc	13.00
Database	Fun School 2 6-8 (A) Disc	10.00
Database	Fun School 2 under 6 (A) Disc	10.00
Dorak	Nol a Penny More (B) Disc/Book	6.00
Impact	Arcade Soccer (A) Disc	10.00
Impact	Chocks Away (A) Disc	15.00
Impact	Clobber (C) Disc	5.00
Impact	Holed Out (A) Discs	10.00
Impact	Nevryon (A) Disc	10.00
Impact	Nevryon (C) Disc	8.00
Impact	Olympics (A) Disc	10.00
Impact	Powerband (A) Disc	14.00
Impact	Quazar (A) Disc	6.00
Impact	Real McCoy (A) Disc	18.00
Impact	U.I.M. (A) Disc	13.00
Impact	Zenon (C) Disc	5.00
Incentive	Moon Cresta (B) Disc	6.00
Melbarne	Way of the Expli Fist (B) Disc	6.00
Micro Pow	Dr Who & Mines (MB+) Disc	6.00
Micro Pow	Magik 10 Hills (C) Disc	4.00
Minerva	Freddy's Folly (A) Disc	6.00
Minerva	Minotaur (A) Disc	7.83
Minerva	Mistle Control (A) Disc	7.



# Mode to mode



The original picture

*Ivan Sayer works wonders on a rather tatty looking graphics screen*

able to take a graphics screen in any mode and transform into any other mode, but we can travel a fair distance toward this ideal by understanding what this routine does.

## How it works

The program proceeds through screen memory re-arranging the bits of each byte like this:

7 6 5 4 3 2 1 0

becomes:

7 5 3 1 6 4 2 0

This means that the odd bits are grouped together in front of the even bits. This may seem quite barmy to the uninitiated but the reason is simple.

As you will find out if you read a few of those articles on graphics, each byte on a mode two screen controls two pixels. It would be very convenient if the left four bits worked the left pixel and the other four bits the right pixel.

Alas, the last thing those hardware merchants consider is programmer convenience – you never hear them talk about user-friendliness.

The odd numbered bits control colour on the left pixel and the even bits control colour on the right. But in Mode 0 this is not so. Each bit is a pixel in its own right.

Nevertheless, by this re-arrange-

ment, colours of Mode 2 can often be transformed into shades of grey in Mode 0. Only a very experienced Beeb artist could produce them from keyboard or program.

The interesting development is that you can do it again:

7 6 5 4 3 2 1 0

becomes:

7 5 3 1 6 4 2 0

becomes:

7 3 6 2 5 1 4 0

becomes:

7 6 5 4 3 2 1 0

And, as you see, this re-arrange-

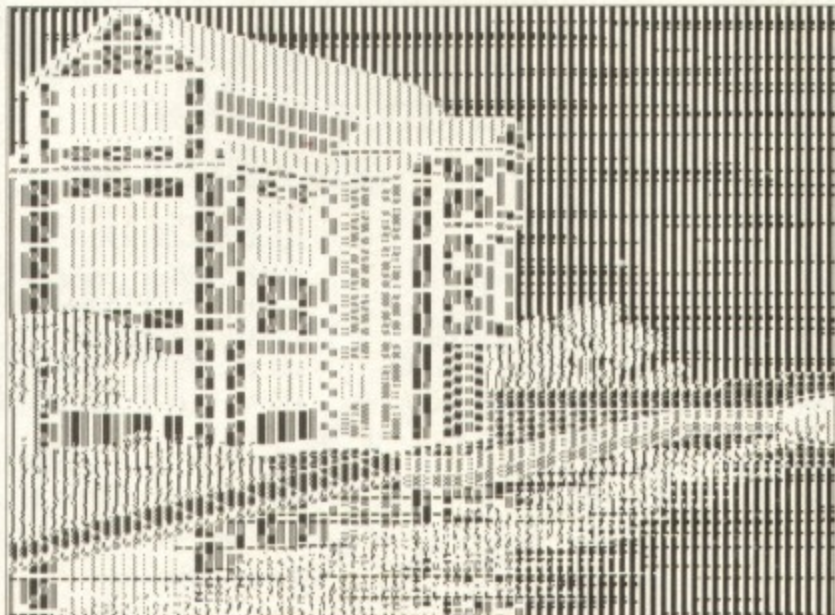

halfway to success

ment gets you back to square one after only three tries. The accepted boffin-speak for this is *permutation* and it has a period of three.

I'm sure you must now be guessing my punch line. We have a third permutation and a third hi-res graphics mode, as yet unmentioned. Sure enough, if you look at the bit order after two re-arrangements you have:

7 3 6 2 5 1 4 0

A Mode 1 screen byte controls four pixels. The leftmost is controlled by bits seven and three, the next by bits six and two, the next by bits five and one and the rightmost by bits four and zero.

So from our original Mode 2 screen we may also get a Mode 1 equivalent by rewriting two lines:

```
10MODE1
100CALL @0A00:CALL @0A00
```

Load the screen in Mode 1 instead of Mode 0 and call the cleanup routine TWICE and you will have a Mode 1 equivalent screen.

You can prove that the permuta-

**H**AVE you ever loaded a graphics screen in Mode 0 only to see a vague, distorted version of what you expected to see? The reason is probably because it's been loaded in the wrong mode. Perhaps it should have been Mode 2.

Curiously enough, that vague distorted mess can actually be cleaned up with just 63 bytes of machine code.

This routine won't change your life, but there are times when it can be very useful. In addition, it offers a novel insight into the organisation of screen memory in graphics modes on the BBC Micro.

By graphics modes we mean Modes 0, 1, 2, 4, 5 and the unofficial graphics mode which I shall call Mode 8. The text modes, 3 and 6, are organized in the same way, apart from the black lines which can be programmed out. Only Mode 7 is radically different.

Type in Listing 1 and ensure you've made no typing errors by using the checksums. Run the listing and the resulting code will be saved in a small file called MS. Now type in this short program:

```
10MODE0
20REM LOAD MODESWAPPER
30*LOAD MS
40REM LOAD MODE 2 SCREEN
50*LOAD XXXX
60REM NOW PAUSE FOR SPACEBAR PUSH
70REPEAT:A=GET:IF A<>820 VDU7
80UNTIL A = 820
90REM NOW CLEAN UP MESS
100CALL @0A00
110VDU30:END
```

Replace XXXX with the file name of a Mode 2 graphics screen that has been saved on the current drive and directory, it will be loaded in Mode 0, so you can now stare at the ghastly mess while the program waits for you to push the spacebar.

When you do so the program calls the machine code and in the vast bulk of cases this will transform your mess into a respectable Mode 0 screen. Add your own save command if you want to keep it.

This is a pleasant little trick, and the same, or very similar, routines can be used to perform a number of similar tricks.

I can't quite promise that you'll be





tion is of period three by loading a Mode 2 screen in Mode 2 and calling the routine repeatedly with pauses between calls. Every third call the screen returns to normal.

I have very carefully started from a Mode 2 screen. If you start with a screen programmed or drawn in Mode 0 and change it into Modes 1 or 2, the results are not nearly so pleasing. There are two reasons for this:

Colours will be introduced in a quite random fashion. Combinations can be garish and may flash. Text characters or any user defined characters will often become quite unrecognisable. But a large amount of good graphics is programmed in Mode 2, so you should not be short of screens to play with.

Very similar tricks can be played in Modes 4 and 5. But there is the extra hassle that the lo-res version of Mode 2 is not official. The Advanced User Guide has a program which sets it up, but there are not many screens for it.

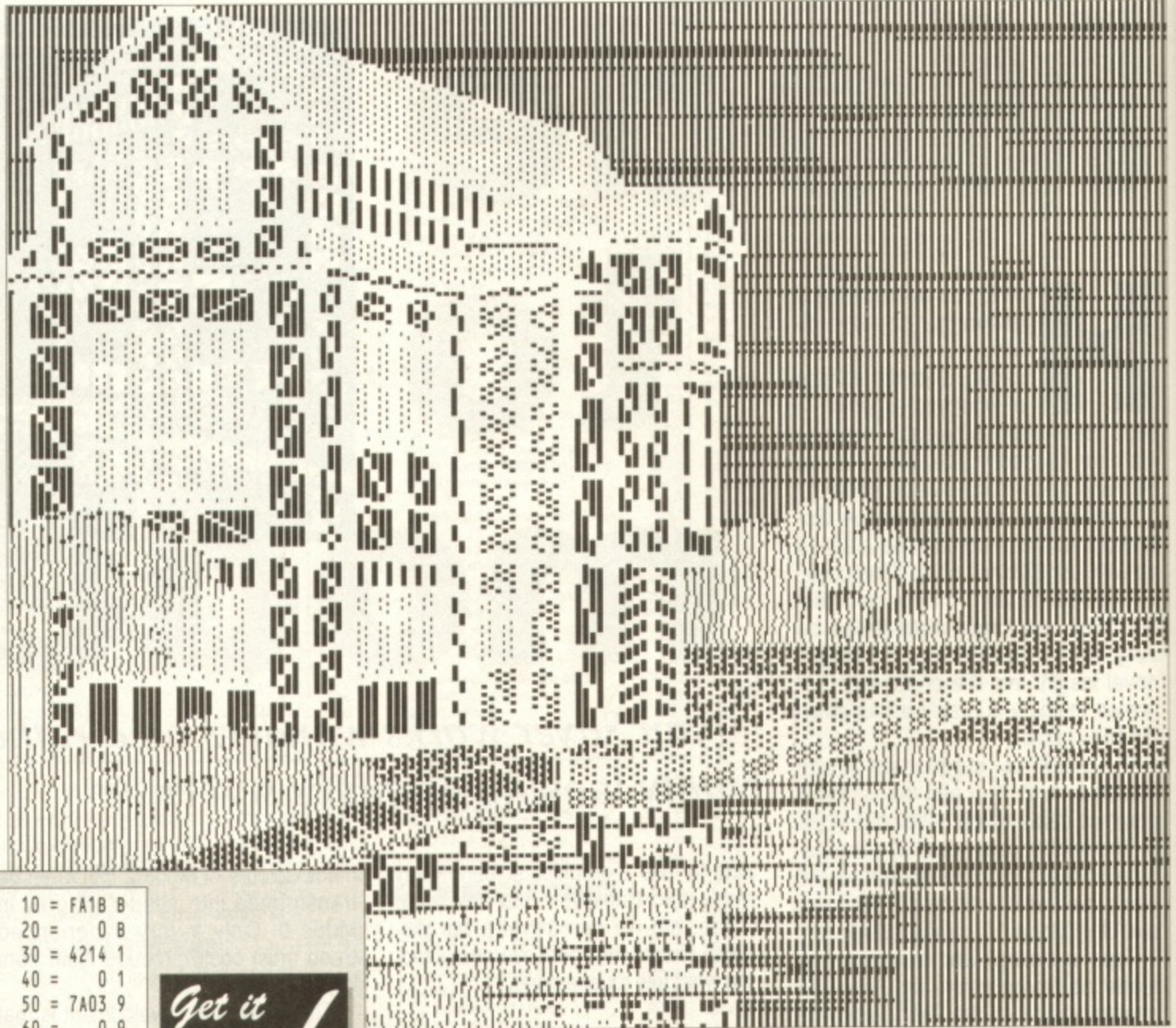

The final result

```
10 MODE0
20 REM LOAD MODESWAPPER.
30 *LOAD MS
40 REM LOAD MODE 2 SCREEN.
50 *LOAD S.CG
60 REM NOW PAUSE FOR SPACEBAR PUSH.
70 REPEAT:A=GET:IF A<>20 VDU7
80 UNTIL A = 820
90 REM NOW CLEAN UP MESS.
100 CALL 80A00
110 VDU30:END
```

```
10 = FA1B B
20 = 0 B
30 = 4214 1
40 = 0 1
50 = 7A03 9
60 = 0 9
70 = F3 0
80 = 1AAF 5
90 = 0 5
100 = 25C0 7
110 = 3B15 A
```

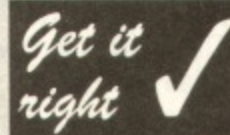

```
10 REM MODESWAPPER.
20 REM BY IVAN SAYER.
30 REM (C) THE MICRO USER.
40 MODE7:ON ERROR PRINT ERR,ERL:STOP
50 PROCassemble
60 $89C0="SAVE MS 0A00 "+STR$P%
70 X%=&C0:Y%=&09:CALL &FFF7
80 END
90 DEF PROCassemble
100 CODEX=&A00
110 FOR pass%=0 TO 3 STEP 3
120 P%=CODEX
130 [OPT pass%
140 .CODEX
150 CLD
160 LDA #830\Set screen start in
170 STA 871 \locations 870,871
180 LDA #800
190 STA 870
200 .LOOP%
210 LDY #807\Countdown screen locations
220 .LOOP1% \in groups of eight.
230 LDA (&70),Y\Load current location.
240 TAX \Save a copy in X.
250 JSR BTS% \Cream off odd bits.
260 TXA \Get saved copy.
```

```
270 ASL A \Lose the top bit.
280 JSR BTS% \Cream off even bits.
290 LDA 873 \Load re-arranged byte.
300 STA (&70),Y\Store current location.
310 DEY \And so on.
320 BPL LOOP1%
330 LDA 870 \Inc. address by eight
340 CLC \until screen finished.
350 ADC #808
360 STA 870
370 BCC LOOP%
380 INC 871
390 LDA 871
400 CMP #880
410 BNE LOOP%
420 RTS
430 .BTS%
440 ASL A
450 ROL 873 \Grab bit.
460 ASL A \Skip bit.
470 ASL A
480 ROL 873 \Grab bit.
490 ASL A \Skip bit.
500 ASL A
510 ROL 873 \Grab bit.
520 ASL A \Skip bit.
```

```
530 ASL A
540 ROL 873 \Grab bit.
550 RTS
560 ]
570 NEXT pass%
580 ENDPROC
```

```
10 = 0 0
20 = 0 0
30 = 0 0
40 = D209 9
50 = 126A 1
60 = AB40 6
70 = 51A 3
80 = FD2E 9
90 = 98A5 C
100 = BBF 3
110 = 420C B
120 = D356 9
130 = 95CD F
140 = B7F0 F
150 = 41C 1
160 = 2228 9
170 = 4D60 0
180 = 777B E
190 = 5660 6
200 = DE7E 0
210 = 105A 1
220 = EBA3 6
230 = 35C0 6
240 = C306 A
250 = BF10 8
260 = E3BC 5
270 = 9143 E
280 = BF10 7
290 = FE8F 9
300 = 7F58 E
310 = D02D E
320 = 9A9B 9
330 = 105D 8
340 = 60F8 4
350 = 2B57 1
360 = 5660 D
370 = FCA8 2
380 = 5A71 9
390 = E157 6
400 = 53F8 3
410 = BE9 8
420 = 9843 F
430 = E9CD 2
440 = 6311 4
450 = D03A 3
460 = F4FA 8
470 = 6311 1
480 = D03A 8
490 = F4FA F
500 = 6311 5
510 = D03A 3
520 = F4FA D
530 = 6311 2
540 = D03A C
550 = 9843 A
560 = 8B58 D
570 = 5D94 6
580 = ED0F 6
```

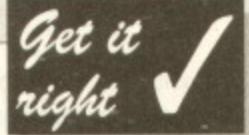



# Accounts Manager

## The Professional Solution

### FEATURES

- ✓ Sales, Purchase, Nominal Ledgers
- ✓ Budget Reports
- ✓ Sales/Purchase Analysis
- ✓ Debt Chasing and other letters
- ✓ Aged Debt Analysis
- ✓ Statements (User Definable)
- ✓ Re-Occurring Transactions
- ✓ Receipt/Payment/Refund & Contra Processing
- ✓ Invoice Search Facility
- ✓ RISCOS multi-tasking
- ✓ Text Editor
- ✓ Trial Balance/Quick Ratio
- ✓ VAT Return
- ✓ Profit/Loss & Balance Sheet
- ✓ Self re-building data files
- ✓ Hold transaction or Account
- ✓ Miscellaneous Accounts
- ✓ Upgradeable
- ✓ Full Support included
- ✓ Mouse or Keyboard Driven
- ✓ Now Includes Freeform Invoicing

**KENDAL COMPUTER CENTRE**  
68 Stramongate, Kendal, CUMBRIA LA9 4BD  
Tel: 0539 722559

Accounts Manager is the ultimate Archimedes Accounting system on the market today. It is not written to run under an emulator and is not ported from another machine, it simply takes full advantage of the raw power of the Archimedes and A3000 computers to ensure that the computerisation of your accounts is as simple as possible.

Accounts Manager is very simple to learn and use, data entry is clear and logical, reports and concise and to the point.

Because Accounts Manager puts you in control of your finances, it can greatly improve your cash flow, as well as perform the traditional functions such as VAT returns and Profit/Loss reports.

Priced at only £299.00 +VAT, there is really only one choice if you are serious about computerising your accounts. Contact your dealer for a demonstration TODAY.

*Alsystems*  
EDUCATION AND TRAINING MICROCOMPUTER SYSTEMS



Telephone ALTON (0420) 561111



# WE'VE MOVED!

Opening on 9th September, our new premises will enable us to provide you with better training and showroom facilities.

**47 WINCHESTER ROAD,  
FOUR MARKS, ALTON,  
HANTS, GU34 5HG.**

**NEW TELEPHONE 0420 561111**

# TRAINING COURSES

After running successful PC based courses locally we are now extending our range of courses to cover the Archimedes & A3000 together with the major software products available.

1/2 and full day courses are available  
eg. Impression, MultiStore, Atelier  
Timetabler, Minerva Accounts  
Pipedream, FlexiFile  
Archimedes Awareness

## PrimeArt

PrimeArt is a 256 colour art package designed for use with Primary and Special Needs children. Teachers can tailor the menus to suit the ability of each class or child.

£79.95 + VAT  
(inc Primary Licence)



**MINERVA**

ACCOUNTS  
ANCESTRY  
ATELIER  
DESKTOP OFFICE  
EASIWORD  
FLEXIFILE  
GAMES  
GAMMAPLOT  
GRAPHBOX  
HOME ACCOUNTS  
MULTISTORE  
PC ACCESS  
PRIMEART  
SIGMASHEET  
SYSTEM DELTA  
TIMETABLER

MINERVA SOFTWARE, MINERVA HOUSE, BARING CRESCENT, EXETER, EX1 1TL  
Tel 0392 437756 Fax 0392 421762

Please send me your brochure for Software  Training

Name.....  
Address.....  
Ref 189  
MLW

## Gnome Computers Limited

25A Huntingdon Street, St. Neots, Cambs, PE19 1BG  
Tel./Fax: 0480 406164 E-Mail: support@gnome.uucp

## X Window System R11.4

This new software package converts a RISC OS based Archimedes into an X Terminal. The software will allow communication with X clients over Ethernet, Econet or serial line.

X Software .....£199  
Complete X Terminals from .....£1550

### Archimedes upgrades

30MHz ARM 3 Upgrade.....£430  
A440/R140 4-8MB Memory Upgrade .....£675  
External SCSI 200MB H/D + Acorn SCSI Card.....£1250  
External SCSI 750MB H/D + Acorn SCSI Card.....£1700  
External 150Mbyte SCSI Tape Drive .....£850

### Transputer Systems

Gnome Computers offers a complete range of transputer boards to fit into either RISC OS or RISC iX based Archimedes machines. Prices start at £1385 for a single 10 MIP, 2 MFLOP transputer system including a parallel FORTRAN-77, C, Pascal, Modula-2 or Occam compiler.

## UNIX Specialists

## LaserDirect HiRes complete package - now only £949.00!

C.C./Canon LBP4 600 x 600 d.p.i. HiRes LaserDirect - £949.00  
+ VAT £166.08 + p&p £9.00 = Total £1124.08

C.C./Canon LBP8 600 x 600 d.p.i. HiRes LaserDirect - £1275.00  
+ VAT £223.13 + p&p £9.00 = Total £1507.13

C.C./Qume 300 x 300 d.p.i. LaserDirect - £849.00  
+ VAT £148.58 + p&p £9.00 = Total £1006.58

Scan-light A4 - £349.00 + VAT £61.08 + p&p £7.00 = Total £417.08

Scanlight Junior - £175.00 + VAT £30.63 + p&p £7.00 = Total £212.63

Impression II - £129.95 + VAT £22.74 + p&p £2.00 = Total £154.69

Business Supplement - £39.00 + VAT £6.83 + p&p £1.00 = Total £46.83

Impression Junior - £72.00 + VAT £12.60 + p&p £2.00 = Total £86.60

Poster - £75.00 + VAT £13.13 + p&p £2.00 = Total £90.13

Pipedream 3 - £115.00 + VAT £20.13 + p&p £2.00 = Total £137.13

To order, or for more information, phone 0689 872127  
or send cheque payable to "Chelsfield Publications",  
To: Chelsfield Publications, 2 Bucks Cross Cottages,  
Chelsfield Village, Orpington, Kent. BR6 7RN



Chelsfield  
Publications

## Five Megabytes

of High Quality Clipart for  
the Archimedes & A3000.

Over 350 Mono Images  
compressed onto 4 disks

with Topics  
ranging from  
Animals to Signs  
to Trees!



The  
ClipArt  
Collection



Units 18e & 18f Boxer Place,  
Moss Side Employment Centre, Leyland, Preston,  
PR5 3QL

Telephone (0772) 623000 Fax (0772) 622917

Educational & Government Orders Welcome



The Graphics Factory

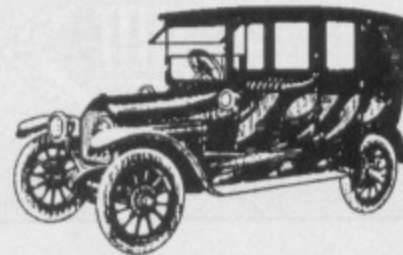

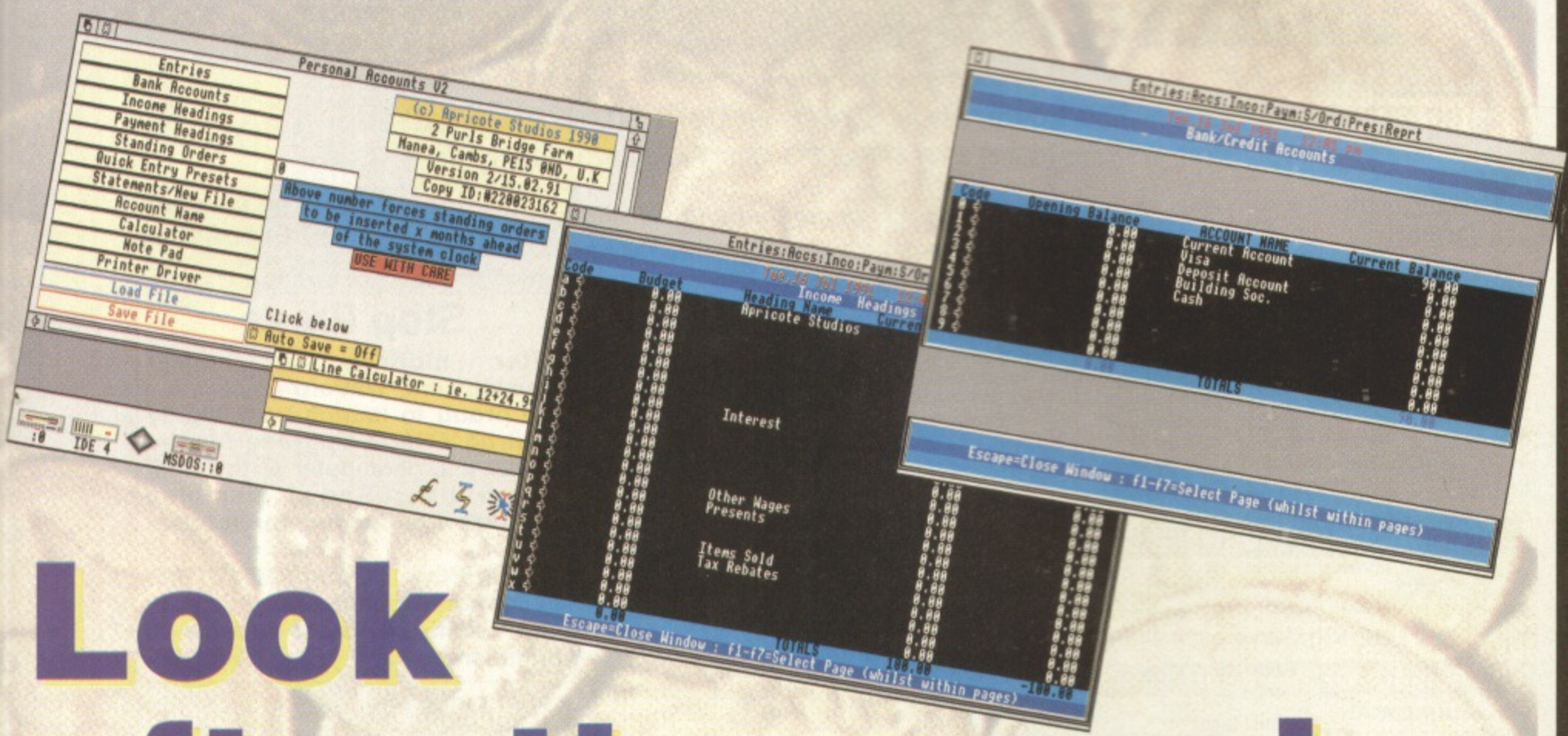

# Look after the pennies

... and the pounds will look after themselves when you put your finances into order with one of the 20 copies of Personal Accounts we're offering as prizes

**N**OW is as good a time as any to get yourself organised, and to help you do just that Apricote Studios are giving away 10 copies of their superb Personal Accounts package for the 8 bit BBC Micro as well as offering you 10 copies of the new Archimedes/BBC A3000 version.

Worth £18.95, Personal Accounts for the BBC Micro works equally well whether you have a BBC B, Master or Compact.

The aim of this program is to make accounts as simple and intuitive as possible. By following the step by step instructions you'll find yourself analysing your income and expenditure as well as producing a complete breakdown of your cash transactions.

You decide what you want to incorporate from standing orders or direct debits, from credit card accounts to a list of your assets.

Version 2 of Personal Accounts has been rewritten to take into consideration the power of the Archimedes by utilising Simtron's Archway system.

Priced at £28.95, Personal Accounts is fully Risc OS compatible and multi-tasking. You use just one window to input all your details with up to 10 accounts accessed from the same window.

This same design allows you to transfer money between accounts and if you prefer the double-entry system you can revert to this at will.

## What you have to do

Answer the following five general knowledge questions with a financial bias then complete the entry form and send it to **The Micro User** to arrive no later than October 31.

The first 20 correct answers to be pulled from the sack will receive one of Apricote's Personal Accounts.

## Test your knowledge

1. The Dow Jones Index is connected with the stock exchange of which country? (a)USA (b)Japan (c)UK (d)France
2. The Wall Street Crash occurred in which year? (a)1983 (b)1927 (c)1929 (d)1945
3. What is the current rate of VAT? (a) 12.5% (b) 15% (c)17.5% (d)20%
4. On which London street would you find the Bank of England? (a)Fleet Street (b)Threadneedle Street (c)Bow Street (d)Marylebone Road
5. Which of these banks is allowed to print banknotes?  
a Royal Bank of Scotland  
b Clydesdale Bank  
c Bank of Ireland  
d Girobank

## ENTRY FORM

Name \_\_\_\_\_  
 Address \_\_\_\_\_  
 \_\_\_\_\_ Postcode \_\_\_\_\_

**My computer is a** (please tick the relevant box):

- BBC B
- BBC B+
- BBC Master
- BBC Master Compact
- A3000/Archimedes

**I need the following format** (please tick the relevant boxes):

- ADFS  80T
- DFS  5.25in
- 40T  3.5in

## Answers

1.  2.  3.  4.  5.

Now send this to: Apricote Competition, **The Micro User**, Europa House, Adlington Park, Macclesfield SK10 4NP.

# Watford Electronics

(A member of the Jessa group of Companies - Established 1972)



Jessa House, 250 Lower High Street, Watford WD1 2AN, England

Tel: Watford (0923) 37774 Tlx: 8956095 Fax: (0923) 33642



The sign of  
Quality

Shop Hours: 9am to 6pm (Mon.-Sat.) Thursday 9am to 8pm. FREE customer car park.

All prices exclusive of VAT; subject to change without notice & available on request.

The choice  
of Experience

## Archimedes micro

System	Basic	Mono Colour	Multiscan
410/1	£1099	£1159	£1448
420/1	£1299	£1359	£1648
440/1	£1699	£1759	£2048
540/1	£2995	£3065	£3178

### Archimedes A3000

12 MONTHS  
FREE  
MAINTENANCE  
ON SITE

- A3000 Microcomputer **£599**
- A3000 + Learning Curve pack **£699**
- 3.5" External Drive **£99**
- Monitor Stand **£16**
- External Podule Case **£13**
- User/Analogue Port Upgrade **£42**
- Serial Upgrade **£17**
- Technical Manual **£60**
- SCSI Card **£149**
- Dust Cover Micro only **£5**
- Dust Cover for Micro + Monitor **£9**
- User port/MIDI upgrade **£45**
- UHF TV Modulator **£30**

### Unbeatable Sale Offers on Archimedes Micro

When you purchase an Archimedes Micro from Watford, look what you get FREE with it

Micro	Free Offer
A410/1	Upgraded to 2MB RAM & 44MB IDE Hard Drive
A420/1	Upgraded to 4MB RAM & 100MB IDE Hard Drive, MkII Learning Curve pack incl. Acorn DTP pack
A440/1	High Res 14" Multiscan Colour Monitor
540/1	High Res Multiscan Monitor & Panasonic KX-P1180 Printer
A3000	Upgraded to 2 Megabyte of RAM & a A3000 Monitor plinth.

+ 12 months FREE On-Site Maintenance (P.S. Instead of the above Hardware upgrades on A410/1 & A420/1, we will fit the 30MHz Turbo Board if required. Please specify your requirement when ordering.)

### Archi Accessories

- NEW Multitasking RISC OS **£29**
- 3.5" 800K 2nd Floppy Drive (305/310) **£118**
- 5.25" 800K external Floppy Drive **£85**
- I/O Podule (with Analogue port, User port, & 1MHz bus) **£76**
- MIDI add-on to I/O Podule **£27**
- MIDI Expansion Card **£65**
- Sound Sampler Mono (Armadillo) **£129**
- Sound Sampler Stereo /Midi (Armadillo) **£186**
- Chromalock Podule (Wild Vision) **£275**
- Econet Network Board **£44**
- Archimedes IEEE Interface Adaptor **£269**
- Dual RS232 Podule **£195**
- 16 bit parallel I/O Card **£195**
- Archi replacement mouse - New design **£32**
- PC Emulator NEW Faster Version **£62**
- Software Developers Toolbox **£149**
- Floating Point Unit **£455**
- SCSI Adaptor Expansion Card **£162**
- Keyboard Extension Lead **£6**
- 2 Podule Backplane **£25**
- 4 Podule Backplane **£38**
- Fan for above backplanes **£8**
- Risc Os Extras Software Disc **£5**
- Smoked Perspex Low profile Keyboard Cover **£8**
- Ethernet Card **£220**

### 8 Meg RAM Upgrades

- R810 - A410/1 upgraded to 8MB **£599**
- R820 - A420/1 upgraded to 8MB **£569**
- R840 - A440/1 upgraded to 8MB **£499**
- R814 - R140 upgraded to 8MB **£499**

### Turbo Charge Your Archimedes

Increase the speed of your Archimedes by a factor of THREE to SIX times (depending on the software you are running), with Watford's ARM3 Upgrades.

- ARM-3 Upgrade Board **£299**
  - MEMC 1A Upgrade **£42**
- (ARM 3 price includes a FREE Chip extraction tool) (Special Offer - If purchased together with an Archimedes Micro, then not only will we fit the card Free of Charge but we will also reduce the price by £25 i.e. You pay only £274 for ARM3 Board)

### Archimedes RAM Upgrade

All our memory upgrades are simple to fit. No soldering required. Fitting instructions supplied.

- R302-A3000 - to 2MB RAM Upgrade **£35**
- R303-A3000 - to 2MB RAM Upgrade (expandable to 4MB) **£69**
- R304-A3000 - to 4MB RAM Upgrade **£159**
- R311-A305 - to 1MB RAM Upgrade **£50**
- R312-A305/310 - to 2MB RAM Upgrade **£215**
- R314-A305/310 - to 4MB RAM Upgrade **£405**
- R412-A410/1 - to 2MB RAM Upgrade **£35**
- R413-A420/1 - to 4MB RAM Upgrade **£64**
- R414-A410/1 - to 4MB RAM Upgrade **£98**

### Archimedes Hard Disc

Watford's ST506 Hard disc drives for A310 & A410 series fit internally into the space provided. The 'simple to follow' fitting instructions supplied makes drive fitting very easy. All disc drives are auto parking. 40Meg & 53Meg drives are fast 24mS type, while 20MHz are 28mS.

P.S. A310 upgrades require a backplane and a fan.

- 3HDP - Hard Disc Podule only **£135**
- 3HD20 - 20Meg H' Disc + Podule for 310 **£235**
- 3HD40 - 40Meg H' Disc + Podule for 310 **£345**
- 3HD50 - 53Meg H' Disc + Podule for 310 **£474**
- 4HD20 - 20Meg Hard Disc for 410 **£129**
- 4HD40 - 40Meg Hard Disc for 410 **£215**
- 4HD50 - 53Meg Hard Disc for 410 **£335**
- A3000 20Meg Hard Disc + Podule **£299**
- A3000 40Meg Hard Disc + Podule **£429**

IDE HARD Disks: See page 14 of our advert.

### Convert your Archi 410 to a 420 or 440 with Watford's unique Upgrade Kits

- UP10 - to 2MB RAM + 20MB Hard Disc **£165**
- UP15 - to 2MB RAM + 40MB Hard Disc **£252**
- UP20 - to 4MB RAM + 20MB Hard Disc **£232**
- UP30 - to 4MB RAM + 40MB Hard Disc **£318**
- UP40 - to 4MB RAM + 53MB Hard Disc **£438**

### Silicon Vision

- Gerber Plot **£95**
- Solid CAD **£120**
- Super Plot **£28**
- Arc PCB Professional **£275**
- Realtime Solids Modeller **£136**
- Super Dump **£22**
- Solids Render **£120**
- Solid Tools **£279**

### Archi Mouse Port Splitter

Our handy little splitter unit eliminates the risk of damaging your micro due to constant plugging and unplugging of the mouse by allowing you to connect both, a joystick and a mouse simultaneously to your Archimedes. **£15**

## Stop Press

After months of secret development, Watford Electronics are proud to launch their highly desired ARM 3 Upgrade for the A3000 microcomputer at the BBC Acorn User Show, Wembley Conference Centre, in October 1991.

You are invited to preview this exceptional board on our stand. Our technical staff will be in attendance.

## Graphics, Art, Design & Games

GRAPHICS		Manchester United	
Atelier	£65	Nevryon	£14
Artisan II	£45	Olympics	£15
Artisan Gallery	£16	Pipe Mania	£17
Autosketch II	£65	Pirate	£16
Craftshop 1 & 2	£28	Power Band	£18
Euclid 2	£50	Puncman 1 & 2	£16
Graph Box	£59	Puncman 3 & 4	£16
HotLink Presenter	£40	Pysanki	£15
Kermit	£46	Real McCoy	£22
Mogul	£17	Real McCoy 2	£23
Poster	£79	Redshift	£14
Pro Artisan	£70	Return to Doom	£16
Render Bender	£58	Revelation	£54
Snippet	£21	Repton 3	£15
Tween	£21	Rotor	£19
		Splice	£25
		Sporting Triangles	£24
		Star Trader	£14
		Superior Golf	£15
		Talisman	£12
		The Pawn	£19
		Thundermonk	£11
		Timewatch	£24
		Trivial Pursuit	£22
		Twin World	£15
		U.J.M.	£23
		White Magic	£15
		White Magic 2	£15
		Wimp Game	£15
		Worldscape	£16
		<b>Miscellaneous</b>	
		Ancestry	£59
		Arccomm 2	£38
		Arcterm 7	£64
		Armadeus Sound	£60
		BBC DFS Reader	£6
		Broadcaster Loader	£65
		Equasor	£40
		FlexiFile	£98
		Genesis	£65
		Genesis 2	£113
		Hearsay Comms	
		Pack	£50
		Investigator 2	£22
		JX Archi Colour Printer	
		Driver for Citizen &	
		Star	£15
		Numerator	£66
		Presenter 2	£35
		Presenter Story	£145
		Revelation	£58
		Rhapsody in Blue 2	£45
		Speech!	£15
		Toolkit (Claires)	£35
		Touchtype	£40
		Tracer	£46

## LANGUAGES (Archimedes)

ISO-PASCAL; FORTRAN 77	£77 each
Assembler; LISP; Prolog X	£149 each
ANSI C Rel. 3	£125
Cambridge Pascal	£60
Macro Assembler	£40
Robo Logo	£69
BASIC Compiler	£77
Logotron Logo	£45
Risc Basic	£120
Risc FORTH	£110

## Minerva's Archimedes Software

Home Accounts*	£36	Sales Ledger*	£53
Stock Manager*	£53	Purchase	
Nominal Ledger*	£53	Ledger*	£53
Ancestry	£59	Reporter	£29
System Delta+	£55	Mailshot*	£29
System Delta + Reference Manual			£25
Order Processing/Invoicing*			£53
School Administrator			£118

\* Requires System Delta

### NEW Business Accounts Packages

Nominal Ledger, Order Processing/Invoicing,  
Purchase Ledger, Sales Ledger & Stock Control  
Price: £78 per Module or  
£299 for the complete Software Suite

## ULTIMUM – Archimedes A3000 Podule Racking System



### THE ONLY LOGICAL WAY TO EXPAND YOUR A3000 COMPUTER

The accepted standard for Archimedes computer expansion is the Acorn Podule, designed initially to fit the old 310, and also for the later A400 and A400/1 series micros. The podules fit inside these computers up to four at a time. The A3000 is the little brother of the family, but can only have one podule at a time, plugging into the back of the computer.

Other attempts have been made to expand the A3000 by trying to introduce a 'mini-podule'. This is impractical for many reasons, amongst which is the reluctance of manufacturers to produce them. Nobody wants to re-design podules already produced. Some cannot be produced on a 'mini-podule' as they are far too complicated and simply wouldn't fit.

Watford Electronics listens to the demands and requirements of its customers, and we are glad to say that we have come up with the only real solution to the A3000 expansion problem. The ULTIMUM Podule Racking System allows up to three FULL SIZE standard Archimedes 300/400 series podules to be fitted to the computer. In addition, there is also provision for a hard disc drive and a podule to be fitted internally.

Since the ULTIMUM Podule Racking System takes proper full size podules, you will be able to use any of the currently available peripheral equipment, from companies like Computer Concepts, Armadillo, Acorn and of course, our own brand. Fitting the podules to 'ULTIMUM' is simple. They are neatly fitted inside the metal case of the rack, avoiding the previously untidy method of hanging the podule off the back of the computer, risking damage to both, it and to the computer.

'ULTIMUM' has its own power supply, so no strain is put on the A3000 power supply. There is also an IEC mains output socket for an Acorn type monitor so reducing the number of plugs required to go to the mains. The ULTIMUM is rigidly clamped over the top and under the computer, and allows direct access to the floppy disc drive and reset button, rather than obstructing access as on other systems. The mounting method employed is so firm that the computer could even be safely transported without the assembly falling apart.

**Price: £125**

## Archimedes A300/A400 SCSI Hard Disc Offer (while stocks last)

100MB Hard Disc Upgrade  
complete with Controller card,  
Cables, Formatter and Manuals

RRP: £999

**Offer Price: £399**

## Archimedes to BBC Serial Link Mk 2

Using this simple data link, it is possible to solve all your BBC to Archimedes data transfer problems. The kit is supplied with a disk, and the necessary cable to connect the two computers.  
New RISC OS Version **Only £15**

## Archimedes External Disc Drive Interface

With this interface it is possible to connect almost any 5.25"/3.5" disc drive with its own power supply to the Archimedes. Upto 4 disc drives can be connected. Fully Buffered Board. NO SOLDERING is involved. Supplied complete with necessary lead.  
• A300/A3000 £21 • A400 £25

## Special Education Prices

All education establishments qualify for special education prices on micros, etc. Please write in or telephone (0923) 37774 or 50335 for written quotation.

## BBC MASTER

**MASTER 128K Micro incl. Acorn's View, Viewsheets, ADFS, BASIC Editor & TERMINAL plus FREE OFFER (see below) £399**

## FREE OFFER

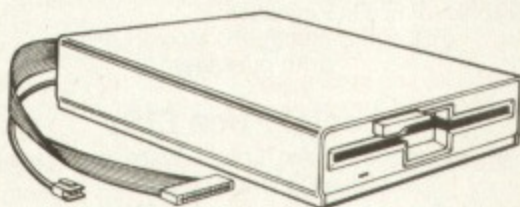

**A 5.25" Double Sided, 40/80 track switchable 400K Disc Drive complete with cables and a Utilities disc incl. 2 games, plus**

*Gemini's OFFICE MATE & OFFICE MASTER packages on Disc consisting of: Database, Spreadsheet, Beebplot graphics. Accounts packs: Cashbook, Final Accounts, Mailist, Easyledger, Invoice & Statements, Stock Control.*

**FREE with every BBC Master purchased from us during August**

## ADD-ONS & ACCESSORIES

Turbo 65C102 Add-on Module	£115
Econet Module for the Master	£45
Twin ROM Cartridge for Master	£9
Quad ROM Cartridge for Master	£14
Master Reference Manual I	(No VAT) £14
Master Reference Manual II	(No VAT) £14
Master Advance Ref Manual	(No VAT) £17
64K Upgrade Kit for B+	£32
Acorn 1772 DFS Kit complete	£49
ECONET Upgrade Kit for BBC B	£42
ALL ECONET UPGRADES Available	
ARIES' IEEE Interface for BBC B & Master	£238
Morley Teletext Adaptor with ATS Rom	£99
Ecolink	£270

## NEW LAUNCH for Archimedes

See Page 14 of  
our advert

## Desk Top Publisher

Acorn's Archi DTP Package	£108
Impression 2 DTP Pack	£135
Impression Junior	£76
Tempest DTP Package	£95

## Archi Wordprocessors

Pendown Archi	£48	Archie Spell Master	£25
Wordwise + Disc	£24	PD Spellchecker	£40
Image Writer	£25	View	£45
Interword Disc	£24	Graphic Writer	£19
1st Word Plus – 2	£63	EasyWord	£30

## Databases

AlphaBase	£36	Multistore	£195
Knowledge Organiser	£42		

## Spreadsheets

Intersheet Disc	£24	Viewsheets	£45
Sigmasheet	£39	Schema	£89

## Business Graphics

GammaPlot	£39	SigmaPlot	£39
Interchart Disc	£17		

## Integrated Packages

- Logistix £79 • Pipedream 3 £119
- Desktop Office – Database, Graphs & Charts, Wordprocessor Spreadsheet, Communications £98
- Desktop Folio – Wordprocessor, Desktop & Interactive Publishing. Ideal for school environment. £85



**CREDIT CARD 24 HOUR  
Ansaphone Hot Lines  
(0923) 50234 or 33383**

## A3000 BBC User, I/O Card, Analogue Port IIC Card

This NEW versatile I/O Card from Watford, fits inside the A3000 and includes an Analog to Digital Converter, a User Port, and an InterIC (IIC) connector.

The card allows many of the peripherals developed for the BBC to be used with the Archimedes A3000. The ADC and User Port have the same pin out and connectors as the BBC computers.

Extensive RISC OS software is supplied to provide BBC OSBYTE calls for support of the ADC and User Ports, including the BASIC keyword ADVAL. The software provides extended RISC OS support for separate interrupts from both the ADC and User Ports, permitting easy interrupt driven operation.

The card is provided with all the software in ROM and is automatically loaded when the machine is turned on.

Peripherals connected to the ports can obtain up to 500mA of power at +5V. A fuse is fitted to the card to protect the A3000 from damage arising from accidental short circuit of the power output.

The card is provided with an extensive manual explaining installation, all software commands, connector pin outs, hardware addresses and example programs.

### Features

- An 8 bit User Port with a standard 20 way IDC connector, compatible with the User Port on the BBC computers and the Archimedes I/O Podule.
- A 10 bit Analog to Digital Converter with a standard 15 way D type connector, compatible with the ADC on the BBC range of computers and the Archimedes I/O podule.
- An InterIC (IIC) Port with a 5 pin DIN socket to connect the A3000 to external IIC devices.

**£42**

Call or write in for our NEW 100 page  
Summer Catalogue

Continued → → → → → → → → → →

## Archi A4 Scanner



This new A4 image scanner from Watford Electronics is supplied complete with ROM based module software. Features provided include facilities for zooming in on an image and inverting the image in X and Y directions, saving and printing of the sprite created. Interactive help is supplied using the IHELP application on the Acorn applications discs.

The 216mm scanning width can cope with both desktop scanning of single sheets, photographs, diagrams, etc., with its fast ten page automatic document feeder, but it can also detach from the feeder to become a convenient hand-held full page scanner for larger documents or pictures.

Scanned image control can be freely adjusted in increments of 10 dots per inch from 100 up to 400 dpi resolution with 64 levels of grey scaling. A built in shading controller and manual brightness control achieve optimum image clarity.

Unlike some scanners, which use a red light source, the Watford scanner uses a yellow/green source which vastly improves the light/dark contrast, thus eliminating the effect where any red-based colours are faded down to white and so do not show up in the scanned image.

All these features and facilities combine to make the Archi Page Scanner the fast and convenient way in which to add that extra impact, interest and clarity to documents, reports, instruction sheets, manuals, news letters, etc., from your Archimedes DTP package.

### Introductory Prices:

Archi A4 Scanner	£349
Sheet Feeder for above	£95
Scanner + Sheet Feeder	£419

## Z88 Portable Micro

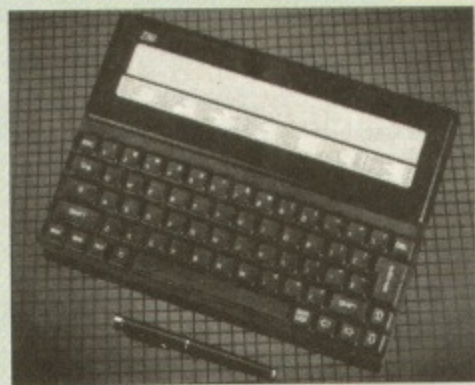

£185

### FREE

With every Z88 purchased from us, we are giving away absolutely FREE, a Z88 to BBC Interface Link, 4 rechargeable batteries and a compact Mains Battery Charger worth £38.

### Z88 ACCESSORIES

• 32K RAM Pack or 32K EPROM Pack	£18.00
• 128K RAM Pack or 128K EPROM Pack	£42
• 512K RAM Pack	£175
• Z88 Eprom Eraser Unit	£33
• Z88 Spellmaster for Pipedream	£45
• Z88 Carrying Case	£8
• Z88 Computing Book	£9.95
• AA Nicad Rechargeable Battery	£1.50
• Battery Charger Compact & Fast	£6
• Z88 Serial Printer Cable	£8
• Z88 Parallel Printer Cable	£25
• Z88 to Archi Link	£15
• Z88 to BBC Link	£20
• Z88 to PC Link II	£30
• Z88 to Macintosh	£52
• Z88 Mains Adaptor	£9
• Z BASE	£56
• Z TAPE	£42
• Z TERM	£42
• Z88 Modem	£149

## Archi Real-Time Digitiser

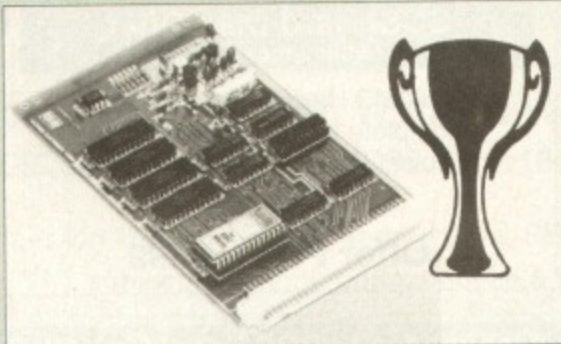

Now supplied with NEW RISC OS Version Software

Watfords' Archimedes Video Digitiser is the most sophisticated digitiser ever designed for a micro. It provides a fast and flexible means of capturing images from a video camera or recorder for display and manipulation on the Archimedes range of Micros. Off-air television signals may also be digitised via a video recorder or TV tuner. Please write for further details.

### Price £175

A Set of Colour Filters for colour image grabbing using a video camera	£16
New Risc-OS Software Upgrade	£39

## Archi Graphic Tablet

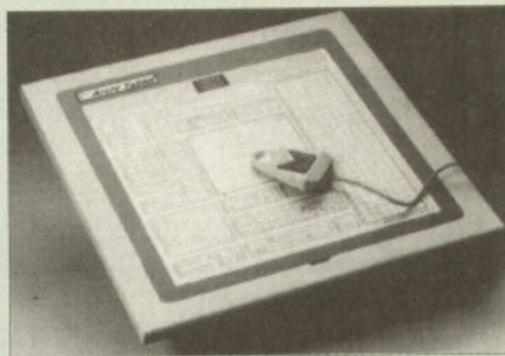

The Archi Graphic Tablet offers performance and accuracy comparable to other tablets priced at well over £400, and has the useful addition of a liftable cover, which can hold tracing material or menu templates securely. The package is supplied complete with sophisticated Archi software. (Now, fully LinCAD compatible. Recommended by Linear Graphic for use in Education).

(FREE this month, PC Mouse Drivers & Art package)

### Special Price £199

(Price includes Tablet, Leads, Software & Puck)  
Stylus Optional Extra £15

Archi Graphic Tablet Junior. Working area 9" x 6". Price includes Stylus £125

## Disc Plonker Rack

When using ones micro, there is a tendency to have more than one Disc on the desk. This exposes them to the hazards of fingerprints, scratches, dust, coffee and an untidy desk. Why not protect your valuable data from all these hazards with the help of our extremely handy and low cost DISC PLONKER RACK. Holds up to eight 5.25" discs.

Protection at Only: £2



## Acorn & Watford DFSs

• Watford sophisticated DFS ROM	£16.00
• Watford DFS Kit complete	£69.00
• We will exchange your existing ROM for Watford's ultimate DFS ROM at only	£12.00
• DFS Manual (comprehensive)	£6.95
• Acorn DNFS ROM	£17.00
• Acorn ADFS ROM only	£25.00
• Acorn 1772 DFS ROM Kit	£49.00

(The single Density DFS system is now old technology. Like Acorn, Watford too have decided to replace it with the their more up-to-date 1770 DDFS interface. We have informed most of the software houses of this decision in order that they can ensure compatibility with our highly sophisticated and fully Acorn compatible DDFS).

## Watford's MkII 1772

### Single/Double Density DFS

Many of our customers have wanted to use our superior DDFS and Acorn ADFS together. Now our Mk II DDFS Board with its 1770 Disc Controller, has been adapted to allow the use of Acorn ADFS as well. It also has all the commands of the Acorn's 1770 DF6, plus the added features.

Added features include:

- Acorn ADFS compatible – Use ADFS on our DDFS board.
- Tube host Code – No longer any need to have the DNFS in your machine to use Co-Processors, even the CoPro and Master 512.
- Auto 40-80 Track sensing – no need to fuss with 40/80 track switches (even works with protected disks).
- An extremely powerful 8271 emulation – ensuring compatibility with almost all software.
- New low profile – small footprint board.
- Fits with all third party ROM boards.
- Option to double the speed of file handling operations – BPUT and BGET.
- Operates in both single and double density modes.
- OSGBP has been recoded, increasing still further the speed of file handling.

Please note that not all DDFS's are capable of providing either the full 80% storage increase or of allowing a file the full size of the disk – Ours allows both of these!

If you already have a DDFS (any manufacturer), and wish to upgrade to our MkII version, then simply return your existing ROM and DDFS board and we will supply the new DDFS for only £39.00.

• SPECIAL PRICE	£44.00
• DDFS Manual	(No VAT) £6.95
• We will exchange your existing DFS Kit for our sophisticated DDFS for only	£30.00

Please note, as the MkII DDFS is a hardware and software upgrade, it is not possible for existing Watford DDFS users to simply exchange the ROM for the new version.

## 3M – Diskettes

3M – SCOTCH Diskettes with Lifetime warranty from Watford Electronics your 3M Appointed Distributor

• 10 x 5.25" S/S D/D 40T (744)	£5
• 10 x 5.25" D/S D/D 40T (745)	£5
• 10 x 5.25" S/S D/D 80 Track (746)	£7
• 10 x 5.25" D/S D/D 80 Track (747)	£7
• 10 x 5.25" 1.6M D/S D/D High Density for IBM XT and AT	£9
• 10 x 3.5" S/S D/D 40/80 Track	£7
• 10 x 3.5" D/S D/D 40/80 Track	£7
• 10 x 3.5" Double Sided High Density	£13

## Top Quality 3.5" & 5.25" Diskettes

To complement our range of Quality Discs and Disc Drives. WE are now supplying SPECIAL OFFER packs of 10 Lifetime guaranteed discs. Each disc has a reinforced hub ring. Supplied complete with selfstick labels and a Plastic Library Disc Box.

• 10 x M3 3.5" D/S D/D 80 Track	£7
• 10 x M9 3.5" D/S High Density	£12
• 10 x M4 5.25" S/S D/D 40 Track	£5
• 10 x M5 5.25" D/S D/D 40 Track	£5
• 10 x M7 5.25" D/S D/D 80 Track	£7
• 10 x M8 5.25" D/S H/D Hi-Density	£9
• M2 3" Double Sided	£2.50 each



CREDIT CARD 24 HOUR  
Ansaphone Hot Lines  
(0923) 50234 or 33383

## Quality Disc Drives from Watford

All our Disc Drives are Double Sided and will operate in both Single and Double Density modes. All 5.25" Disc Drives are 40/80 track switchable. For ease of use, the switches are front mounted. Various UK "manufacturers" of disc drives for the BBC micro (more accurately, "packagers" label other manufacturers drives with their own name). We buy the high quality NEC and Mitsubishi drives in large quantities directly from the manufacturers, package them and sell them at "dealer" prices direct to the public.

If you look around the popular BBC Micro press, you will find that the prices we quote for the top quality, new slimline disc drives are, virtually without exception, the best around. These prices, coupled with the backup of one of the country's largest distributors of BBC peripherals provides a superb deal.

Unless you anticipate using dual drives in a fully expanded BBC system for long periods of time with little ventilation, then we suggest that our range of "CL" disc drives without the PSU (Power Supply Unit) would be quite adequate (extensive tests within our workshops have confirmed this). All drives are supplied complete with a SPECIAL UTILITIES Disc, Cables and Plugs. The Drives with power supply have a mains moulded plug for safety purposes. **Ideal for Schools & Colleges.**

When using a BBC Micro, most people find themselves short of desk space. The Watford's BBC Micro plinths form an ideal way of recovering some of this precious space. Your BBC Disc Drive and Monitor can all occupy the same vertical footprint and still be comfortably situated. With the Watford Double Plinth, your Disc Drive is mounted vertically at one side, leaving a very valuable area directly in front of you for such useful items as spare discs, pen, paper, reference manuals, etc. Follow the trend with a Watford plinth. (Turn to the 6th page of our advert for the Plinths).

P.S. All our 5.25" Disc Drives with PSU are compatible with the Compact Micro. All you require is our special Compact Disc Drive cables designed by us.

**"Test Bureau Approved for Use in Education"**

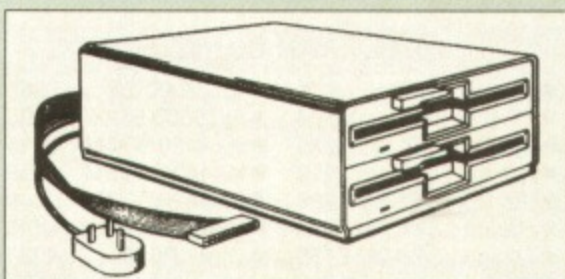
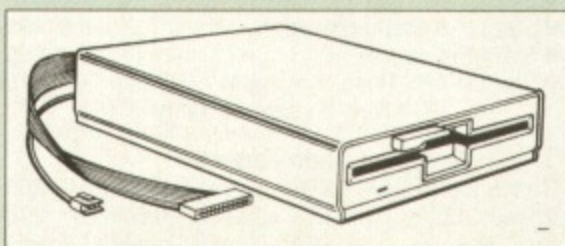

**Our Disc Drives conform to BS415**

Type	Description	
<b>Disc Drive without PSU</b>		
• CLS400S:	Single, 40/80 track 400K Double sided Drive	£72
• CLD800S:	Twin, 40/80 track, 800K Double sided Drives	£142
<b>Disc Drive with PSU</b>		
• CS400S:	Single, 40/80 track, 400K Double sided Drive	£82
• CD800S:	Twin, 40/80 track, 800K Double sided Drives	£155

Special Cable to connect both 3.5" and 5.25" Disc Drives simultaneously to the BBC Compact £13

## Disc Drive/DDFS Offer



- The popular CLS400S 40/80 track switchable disc drive.
  - Watford's popular Mk II DDFS Interface (allows up to 720K storage). Will run both in single & double density modes.
  - A comprehensive DFS Operating manual
- Bargain at Only £116** (Offer valid until stocks last)

## 3.5" DISC DRIVE



These top quality 3.5" Double sided, 80 track, are attractively finished in BBC beige. They are supplied complete with all cables and a Utilities Disc.

Type	Description	
<b>Disc Drive without PSU</b>		
• CLS35:	Single Disc Drive, 400K	£62
• CLD400S:	Twin Disc Drives, 800K	£109
<b>Disc Drive with PSU</b>		
• CS35:	Single Disc Drive, 400K	£83
• CD35:	Twin Disc Drives, 800K	£126

(P.S. CS35 is supplied in a twin case with a blanking plate to enable easy expansion to a dual drive at a later stage)

## Disc Drive Sharer

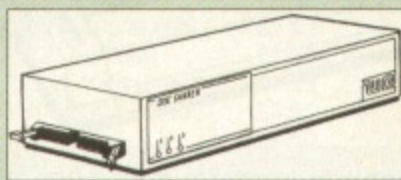

**(Ideal for educational establishments)**

A low cost alternative to the Econet system. Watford's Intelligent Disc Drive Sharer allows you to connect 3 BBC micros (model B, B+ and Master series) to a single or double disc drive. Running under any DFS or DDFS, this intelligent unit will automatically queue the computers. Each computer has a status light dedicated to it. If it is green you will get immediate access to the disk, and red means that you are next in line. The unit plugs directly into the disc drive socket on each computer and is powered by the mains. (N.B. Not for use with ADFS.)

Price includes 3 Cables **£55**

## Disc Drives in Monitor Stand

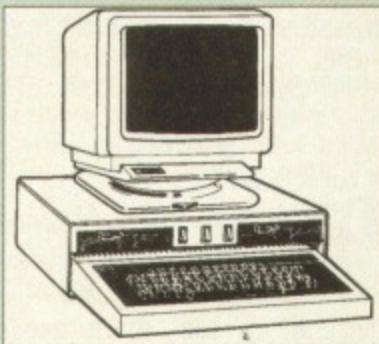

• **CDPM 800S** – Twin 5.25", 800K Double sided 40-80 track switchable disc drives mounted in an attractively finished Beige colour plinth for the BBC B & Master 128K micros. Supplied complete with integral power supply, cables and Utilities disc. The mains switch with neon On/Off light indicator, and the two 40/80 track switches are mounted on the front panel for ease of use.

**£165**

• **DP35 800** – Same as above except, one disc drive is a 5.25" and the other is 3.5".

**£154**

## Floppy Head Cleaner Kit

The heads in floppy drives are precision made and very sensitive to dirt. The use of Cleaner Kit is a sensible precaution against losing valuable data. It is recommended to clean the drive head once a week. It is very simple to use. Available in 3.5" & 5.25", please specify.

**Price £4**

## Antistatic Lockable Disc Storage Units

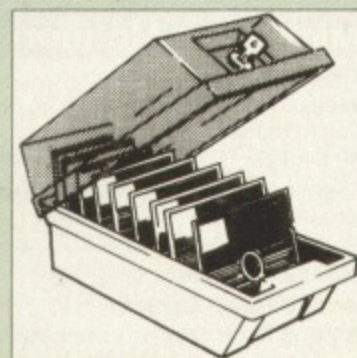

Gives double protection – Strong plastic case that affords real protection to your discs. Antistatic helps avoid data corruption whilst in storage. The smoked top locks down. Dividers and adhesive title strips are supplied for efficient filing of discs.

- **M35** – holds up to 50 5.25" discs **£4.95**
  - **M85** – holds up to 95 5.25" discs **£6.95**
  - **M25\*** – holds up to 25 3.5" discs **£4.95**
  - **M50** – holds 50 3.5" discs **£6.50**
  - **M10** – holds 8 of No. 10 Data Cartridges **£15**
- \* Not lockable

## Plastic Library Cases

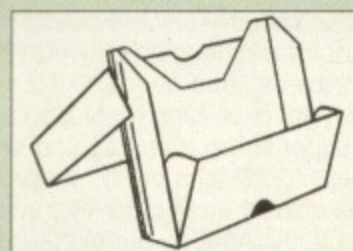

- Holds up to 10 x 3.5" Discs. **£1.50**
- Holds up to 10 x 5.25" Discs. **£2.00**

## Dust Covers (For our Disc Drives)

- Single CLS (without PSU) **£3.20**
- Single CS (with PSU) **£3.25**
- Twin CLD (without PSU) **£3.85**
- Twin CD (with PSU) **£3.90**

## Disc Albums

Attractively finished in black leather-look vinyl. Stores up to 20 discs. Each disc can be seen through the clear view pocket.

**£4**

## Special Bulk Offer on Discs

(Supplied packed in Anti-Static Lockable Storage Units)  
(Lifetime warranty on Discs)



## BULK PACK DISCS in lots of 100

Type	S-S 40T	D-S 40T	D-S 80T
• Without Sleeves 5.25"	£30	£35	£40
• With Sleeves 5.25"	£33	£38	£43
• 3.5" D/S D/D	£29 for 50	£52 for 100	

**Continued** → → → → → → → → → →

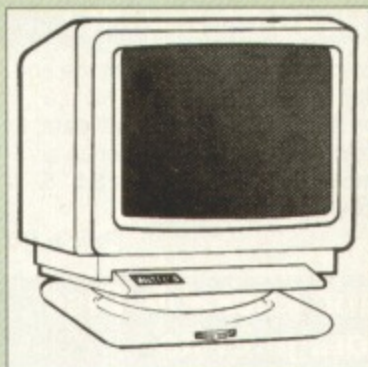

12 months  
FREE  
maintenance  
on site

### Microvitec Monitors

- 1431 - Standard Resolution Monitor £169
  - 1451 - Medium resolution, suitable for word processing in mode 0 £209
  - Cub3000 Medium Res for A3000 £189
  - 1441 - High res, exceeds the capabilities of the BBC Micro £359
  - 2040 CS 20" Hi Res £675
  - Dust Cover for Microvitecs £5.50
  - Touchtec 501 Touch Screen £239
- Now 3 years Parts & Labour warranty on all Microvitec Monitors

### Multiscan Colour

- |                           |                     |
|---------------------------|---------------------|
| ● Eizo 9060S £389         | ● NEC 5D £1299      |
| ● Eizo 9070S £579         | ● Taxan 770LR £379  |
| ● NEC 2A £255             | ● Taxan 775 £375    |
| ● NEC 3D £345             | ● Taxan 795-PC £425 |
| ● NEC 4D £679             | ● Taxan 875 £725    |
| ● VIDC Enhancer Board £25 |                     |
- (P.S. Taxan 795 monitor is supplied with a FREE VIDC enhancer board)

### Aries AlphaScan Monitor

Pound for Pound, the AlphaScan VGA Multiscan monitor provides the maximum performance and greatest flexibility of any 14" colour monitor.

Its multiscan circuitry provides automatic adjustment for frequencies between 30 and 60KHz horizontal, and 50 and 90Hz vertical. Its 0.28mm dot pitch high resolution tube provides super sharp text graphics, while a high speed (70/72Hz) refresh rate provides a flicker-free display easing the eye strain. The Multivideo VIDC Adaptor supplied (free) with the monitor allows high resolution operation in all screen modes.

£325

### Philips Monitors

- BM7502 12" Hi-res Green Monitor £70
  - BM7522 12" Hi-res Amber Monitor £67
  - CM8833 14" Med. Res Colour Monitor £178
  - TV Tuner for CM8833 Monitors £62
  - Dust Cover for Philips Monitors £6
- (Securicor carriage on Monitors £7)

### Spare Monitor Leads

- BNC Lead for Zenith or Philips £3
- Skart Monitor Lead £5
- RGB lead for TAXAN Monitors £3
- Archimedes Colour Monitor Lead £7.50

### Anti Glare VDU Screen

These extremely effective, easy to install, 12" & 14" VDU screens eliminate harmful glare, improves contrast on colour monitors. Increases productivity in offices. A must for wordprocessor users.

£12

### Canon Bubblejet Printers

- | Printer | CSF  | D'ble Bin | Ink Cart |
|---------|------|-----------|----------|
| BJ10E   | £205 | £54       | £18      |
| BJ300   | £354 | £88       | £12      |
| BJ330   | £399 | £110      | £12      |
- Spare Battery pack for BJ10E £33

### NEC Pinwriter Printers

- P20 £186
- P30 £250
- P60 £374
- P70 £475
- P90 £655

### Concept Keyboards

- Standard A3 Keyboard with BBC Software £143
- Standard A4 Keyboard with BBC Software £117
- Archi A3 Keyboard £144
- Archi A4 Keyboard £118

### FREE On-Site Maintenance

This month we are also offering at no extra cost to all our customers, 12 months, On-Site Maintenance on all Multiscan colour monitors, all Panasonic printers, and all Laser Printers, Roland Plotters and of course the full range of Archimedes micros. Should the machine fail, simply telephone the maintenance engineer, who will call in within 12 working hours. (Offer applicable only when bought at prices advertised in this advert. UK mainland only).

### Hewlett-Packard Printers

- |                          |                       |
|--------------------------|-----------------------|
| ● # Desk Jet 500 £299    | ● Paintjet XL £1092   |
| ● Desk Writer (Mac) £482 | ● Quiet Jet Plus £359 |
| ● Desk Jet Cartridge £15 | ● HP Think Jet £239   |
| ● Paint Jet Colour £589  | ● Rugged Writer £839  |
- # Now 3 years extended Parts & Labour warranty

- Paintjet Cartridges Black £19; Colour £25
  - Desk Jet 500 256K RAM cartridge £129
  - HP Epson FX Emulation Cartridge for Desk Jet £59
- HP Apple Talk Interfaces for
- Scan Jet £299
  - Desk Jet Unlimited (Book No VAT) £19.75
  - Paint Jet EPOA

### Panasonic Printers

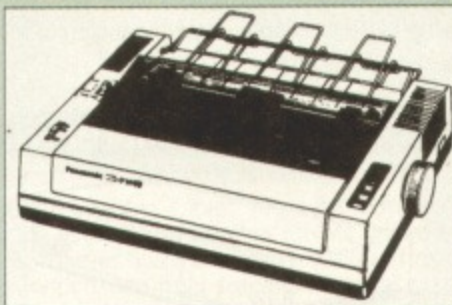

FREE with every KX-P1081 & KX-P1180 Printers: A printer lead (please specify type required) and a Dump Out 3 ROM for the BBC Micro or 1,000 sheets of paper for other micros (please specify)

- KX-P1081 9pin 80col. 144/28 cps £116
- KX-P1180 9pin 80col. 192/38 cps £119
- KX-P1123 24pin 80col. 192/63 CPS £158
- KX-P1124i 24pin 80col. 192/63 CPS £215
- KX-P1624 24pin 132col. 192/63 CPS £299
- KX-P1695 9pin 132col. 330/86 CPS £299
- KX-P1654 24pin 132col. £429

Above prices include FREE, Watford's 12 months on-site maintenance

### Panasonic Accessories

#### Cut Sheet Feeders

- |                          |                     |
|--------------------------|---------------------|
| KX-P1592/1595 (P32) £175 | KX-P1540 (P35) £175 |
| KX-1124 (P36) £79        | KX-P1180 (P37) £70  |
| KX-P1624/1695 (P38) £124 | KX-P1123 (P37) £70  |

#### Buffers

- |  |
|--|
| P12 4K buffer Board for 1081 £55           |
| P42 32K buffer Chip for 1592/1595 £16      |
| P43 32K Buffer Chip for 1540/1124/1180 £16 |

#### Serial Interfaces

- |                    |                    |
|--------------------|--------------------|
| P17 P1081/1592 £32 | P19 P1124/1180 £49 |
|--------------------|--------------------|

### Citizen Printers

- |                |                   |
|----------------|-------------------|
| 120D Plus £96  | 124D Printer £138 |
| Produt 9 £205  | Produt 24 £225    |
| Produt 9X £245 | Swift 24# £205    |
| Swift 9 £138   | Swift 24X £279    |
- Produt Cut Sheet Feeder £120
  - Swift 24 Colour Option £29
  - Swift 24 Ribbons Black £4 Colour £13
- # Special Offer this month - A FREE Colour option cartridge with every Swift 24 printer purchased from us.

### Star Printers

- LC10 9pin 80col. 144/36 CPS £112
  - LC15 9pin 136col. 180/45 CPS £180
  - LC24-10 24pin 80col. 180/60 CPS £150
  - LC24-15 24pin 136col. 200/67 CPS £295
  - \*FR10 9pin 300/76 CPS 31K 16 fonts £229
  - FR15 Wide carriage version of above £290
  - \*XB24-10 24pin 80col. 240/80 CPS £299
  - XB24-15 24pin 80col. 240/80 CPS £365
  - XB-24 Colour Kit £29
  - LC-200 Colour 9pin 80col. 180/45 CPS £158
  - LC-24-200 24pin 80col. 222/67 CPS £189
  - LC24-200 Colour 24pin 80col. 222/67 CPS £222
- \*FREE Colour Ribbon with these printers

### Star Accessories

#### Cut Sheet Feeder

- |                    |                   |
|--------------------|-------------------|
| LC10/200/24-10 £65 | LC15/LC24-15 £125 |
| XB24-10 £80        | XB24-15 £139      |

#### Serial Interfaces

- SPC-10 LC10; LC10-II; LC10-Col; LC15; LC24-10; LC24-15; LC-200; LC24-200 £49
- 8K Ser LC-200; LC24-200; FR10; FR15; XB24-10; XB24-15 £64

#### Paper Roll Holders

- LC-200; LC24-200; LC24-200 colour £29

#### Buffers

- 32K Ram Card for LC/XB24-10; 15; LC200 £55

#### Ribbons

- |                     |           |            |
|---------------------|-----------|------------|
| LC10; LC10-II; LC15 | Black £4; | Colour £6  |
| LC-200; LC24-200    | Black £5; | Colour £12 |
| XB24-10; XB24-15    | Black £5; | Colour £12 |

### Laser Printers

- Canon LBP-4 4ppm £655
  - Canon LBP-8 IIIR 8ppm £1505
  - Canon LBP-8 IIIT 8ppm £1389
  - Epson EPL7100 6ppm £689
  - HP Laserjet III 8ppm £1025
  - HP Laserjet IIID 8ppm £1819
  - HP Laserjet IIIP 8ppm £729
  - HP Laserjet IIIsi 16ppm £2599
  - Panasonic KX-P4420 8ppm\* £648
  - Panasonic KX-P4450i\* 11ppm\* £1025
  - Panasonic KX-4455 Postscript 11ppm\* £1699
  - Qume Crystal Print Publisher 2 £1899
  - Star LP-8 III £979
  - Star LP-8 Star(post)script £1195
  - Star LP-4 4ppm £705
  - Star LP-4PS Postscript 4ppm £875
- \* Now 2 years warranty

#### Laser Toners

- |                 |                          |
|-----------------|--------------------------|
| Canon 2 & 4 £54 | Laserjet IIP & IIIP £55  |
| Epson GQ £18    | Laserjet II/D, III/D £70 |
| Star LP-8 £69   | Qume Crystal £56         |
| KX-P4420/50 £22 |                          |

#### Laser RAM Upgrades

- |                      |                     |
|----------------------|---------------------|
| ● IIP & III 1MB £74  | ● EPL7000 2M £365   |
| ● IIP & III 2MB £109 | ● GQ5000 512K £95   |
| ● II & IID 1MB £76   | ● KX4420/50 1M £115 |
| ● II & IID 2MB £112  | ● KX4420/50 2M £159 |
| ● II & IID 4MB £299  | ● KX4420/50 4M £349 |
| ● Canon LBP4 1M £175 | ● Star LP8 1M £143  |
| ● Canon LBP8 2M £150 | ● Star LP8 2M £285  |

#### Laser Drum & Developer

- Epson Drum GQ5000 £93
- Panasonic 4420 Drum £60
- Panasonic 4450 Drum £93
- Qume Drum £76
- EPL7100 £129
- Developer £59
- Developer £80
- Developer £56

#### Jetpage Postscript Cartridge

- HP IIP/III £255
- IID & IIID £265

#### NEW - HP Laserjet

- Various Font Cartridges £45
- Superset Font £195

### Integrex Colour Jet

- Colour Jet 132 Printer £515
- Paper Roll £6.50
- BBC Screen Dump Software £10
- Colour Cartridge £19.50
- Black Cartridge £11.25
- 100 A4 OHP transparencies £55
- 8K Serial Interface Optional £123



## INCREDIBLE INKJET PRINTERS OFFER

Laser print quality at dot-matrix prices

HP Deskjet 500 Printer	£299
Canon BJ10E Printer	£199

(Offer Valid while the present stocks last)

### Epson Printers

DFX5000	£1089	LQ860 Colour	£465
DFX8000	£1999	LQ1050+	£475
EX1000	£456	LQ1060	£599
FX850	£283	LQ2550+	£709
FX1050	£358	LX400	£109
FX1060	£599	LX850	£150
LQ400	£166	SQ850	£439
LQ550	£209	SQ2550	£645
LQ850+	£385		

#### Cut Sheet Feeders for

LX400/800/850/LQ400/500/550	£69
EX800/FX800/850/LQ800/850	£130
FX/LQ 1000/1050/SQ850	£159
LQ 2550	£390
SQ2550	£390

#### Tractor Feed for

LQ800	£44;	LQ850/FX850	£69;	LQ1050/	
FX1050	£85;	LQ2500	£90;	LQ2550	£90.

#### Accessories

• EX800/1000 Colour Option	£45
• EX800/1000 Colour Ribbon	£14
• LQ2500 Colour Option	£65
• Multifont Card for LQ550/850/1050	£95

### Epson Printer Interfaces

All these interfaces fit inside the printer

RS232	£32	RS232 + 2K Buffer	£52
IEEE 488	£95	RS232 + 8K Buffer	£75

### Printer Leads

BBC Centronics 4' long	£5
BBC Centronics 6' extra long	£7
Compact's Special Centronics Lead	£7
Archimedes Printer Lead 6'	£6
Nimbus Centronics Lead	£6
IBM/Archimedes Parallel Lead 6'	£6
IBM/Archimedes Parallel Lead 5 metres	£13
IBM/Archimedes Parallel Lead 10 metres	£19
Double Ended 36 way Centronics Lead 4'	£7
Double Ended 36 way Centronics Lead 6'	£9
MSX Centronics Parallel Lead 4'	£12
RS232 Leads (Various)	P.O.A.
IBM Keyboard extension lead coiled	£5

### Plotters

• HP7440	£425	• HP7475	£599
<b>Roland Plotters</b>			
• DXY1100	£515	• DXY1200	£645
• DXY1300	£845	• DXY2500	£2375
• DPX3500	£3289	• Sketchmate	£333
• Roland plotter Pens, Fibre tip			£7.50

### Watford VIDC Enhancer

This unique VIDC add-on board for the Archimedes, caters for all types of Multiscan and VGA monitor and mode requirements. There are 2 versions to suit all requirements. The multimode software supplied, provides all the new modes for the selected monitor type, including the now standard Computer Concepts modes. With VGA monitor, you are no longer restricted to a few modes. A WIMP application supplied on disc, allows new modes to be designed and existing modes to be modified for particular monitors.

**Super VGA VIDC Card:** This provides support for both VGA and Multisync monitors. A unique electronic design allows the horizontal and vertical sync to be buffered and have the polarity changed under software control

£45

**MultiVideo VIDC Card:** As above but for MultiScan monitors only.

£25

### Listing Paper (Perforated)

• 1,000 Sheets 9.5" x 11" Fanfold Paper	£7
• 2,000 Sheets 9.5" x 11" Fanfold Paper	£11
• 1,000 Sheets 9.5" x 11" NCR 2 Part Fanfold	£21
• 1,000 Sheets 15" x 11" Fanfold Paper	£9
• 2,000 Sheets 15" x 11" Fanfold Paper	£16
• 1,000 Sheets true A4 Fanfold Paper 70gms	£11
• 2,000 Sheets true A4 Fanfold Paper 70gms	£21
• Teleprinter Roll (Econo paper)	£4

(All our Fanfold paper is Micro perforated leaving a smooth clean edge when the tractor feed strips are detached).

Carriage 1K Sheets £2.50, 2K Sheets £3.00

### Printer Labels

(On continuous fanfold backing sheet)

1,000 90 x 36mm (Single Row)	£6.00
1,000 90 x 36mm (Twin Row)	£6.25
1,000 90 x 49mm (Twin Row)	£7.50
1,000 102 x 36mm (Twin Row)	£6.75

### Special Offer

Hitachi/Acorn 12" High Resolution, ergonomically designed Colour Monitors. Supplied complete with a swivel base and a BBC lead.

**Only: £145** (While stocks last)

### Printer Ribbons & Various Dust Covers

Type	Ribbons	Dust Covers
Brother HR15/20	£6.00	-
BBC Micro	-	£3.50
BBC Master	-	£4.00
Archimedes Micro pair	-	£9.00
Citizen 120D	£2.75	£4.50
DMP2000	£2.75	£4.75
EX800/1000	£3.50	£5.00
RX/FX80/85/800/MX80	£2.95	-
FX/MX/RX100/1000	£3.95	-
Kagá/Taxan KP810/815	£3.25	£5.00
LQ400/500/550/800/850	£3.25	£6.00
LQ1050/LQ2500	£4.00	-
LX80/86/800/850	£2.75	£4.50
LX400	£3.50	£5.00
M1009/GLP	£2.95	£3.75
NEC P2200	£4.50	£5.00
Panasonic KX1080/81	£3.25	£4.75
Panasonic KX-P1124	£7.50	£5.00
SQ2500	£23.00	£5.50
Star LC10/NL10	£2.75	£5.00
Star LC24-10	£2.95	£6.00
Olivetti Ink Jet Cartridges (set of 4)	£9	

Our attractive Dust Covers are manufactured from translucent PCV. The seams are stitched and edges are taped to prevent splitting due to continuous use.

### Original Panasonic Ribbons

Guaranteed to last 3 million characters

P110 for KX-P1081, 1592 & 1595	£6
P115 for KX-P1180	£7
P145 for KX-P1124	£7
P140 for KX-P1540	£8
P155 for KX-P1624	£8
Colour Ribbons for KX-P1081, 1592 & 1595	
Brown, Blue or Red	£9 each

### Professional Printer Stand



The professional printer stand takes hardly more space than your printer. Due to the positioning of the paper feed and re-fold compartments i.e. one above the other, the desk space required for your printer functions is effectively halved. Its ergonomic design ensures smooth paper flow and automatic refolding.

80 Column version £24 (carr. £3)

132 Column version £29 (carr. £4)

### Universal Printer Sharers/Changer

Connect up to 5 Micros to 1 printer or 5 Printers to 1 Micro with our combined, Sharer/Changer. These Units are made to a very high standard. For extreme reliability, they all have Printed Circuit Boards mounted inside the case, (not a Spaghetti Junction of wires). Internal connection is made via high quality ribbon cables.

(Ideal for School environments)

Connects	Serial	Centronics
2 to 1	£16	£17
3 to 1	£22	£24
5 to 1	£32	£36

(Cables extra at £6 each. Please specify type required when ordering)

### 2 Way Compact Printer Switch

A handy 2 way printer switch. Enables one micro to be connected to 2 printers or vice versa.

Centronics £18; Serial £17

(Cables extra at £6 each)

### Auto Printer Sharer Switch

Connects	Serial	Centronics
2 to 1	£40	£45
4 to 1	£62	£59
8 to 1	-	£89

### 256k Multi Spooler

These Auto Centronics Printer Sharers have built-in 256K of Printer Buffers. They can be used as Auto Sharers, Printer Buffers or both.

• 2 In/2 out	£135	• 4 In/2 out	£169
• 8 In/1 out	£199		

### Compact Converter Units

Serial to Parallel £36 Parallel to Serial £37

### Plinths for the BBC B & Master 128K Micros

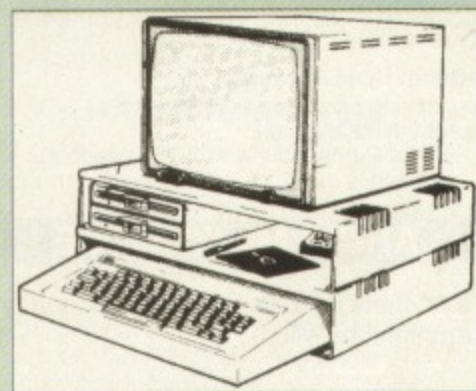

Protect your computer from the heat of your VDU. Our micro plinths have slots for maximum ventilation. The single plinth is suitable for a BBC and VDU, whilst the double height version provides enough room for our stacked disc drive and other peripherals like, Eprom programmer, music unit or simply discs & stationery. The computer slides neatly in the lower section allowing easy access to remove the lid. Colour: Matching BBC Beige.

Single BBC Plinth	420 x 310 x 105mm	£13
Double BBC Plinth	420 x 310 x 210mm	£24
Single Master Plinth	490 x 310 x 105mm	£14
Double Master Plinth	490 x 310 x 210mm	£26

(Carr. Single plinth £2; double plinth £3)

### Perspex Printer Stand

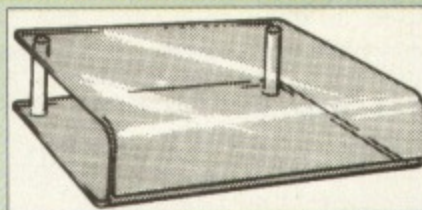

Give your Computer System a touch of Class with our elegant, smoke finished Perspex Printer stand.

80 Column version	£16 (carr £3)
136 Column version	£20 (carr £4)

Continued → → → → → → → → → →

## QUEST MOUSE Mk III



- Quest Mouse III & Quest Paint £59
  - Quest Mouse III, Quest Paint, AMX Stop Press & Pagefont £89
  - Quest Mouse III only £30
  - Quest Paint Software only £34
  - Quest Font Disc (22 Text Fonts) £15
  - Quest Mouse Mat (Red or Blue or Green please specify) £3
  - Quest Colour Dump Disc – This new software allows you to print direct from Quest Paint to your Integrex Colour Printer £18
- (P.S. Quest Paint is not compatible with BBC Compact)

Quest Paint is the winner of the BBC Acorn User 1990 Award for the Best Art/Graphics software

## ConQuest

Quest combined with ConQuest and Acornsoft GXR ROM make up THE MOST POWERFUL drawing packages available for the BBC range. Quest Paint is able to take advantage of almost any additions to your machine, such as Shadow or Sideways RAM. ConQuest takes this principal even further, by utilising the otherwise normally incompatible Sideways RAM facility by holding pictures in them.

**ConQuest ROM Package** £30  
(Price includes software in ROM and a comprehensive Manual).  
(Not Compatible with BBC Compact)

## ARCHI Mk II MOUSE

An extremely reliable replacement mouse for Archimedes Micro £32

## Quest – Tracer ball

An attractively finished, extremely reliable, mouse replacement, input device. Requires very little desk space. Connects directly to your BBC B, BBC Master or Archimedes Micro.

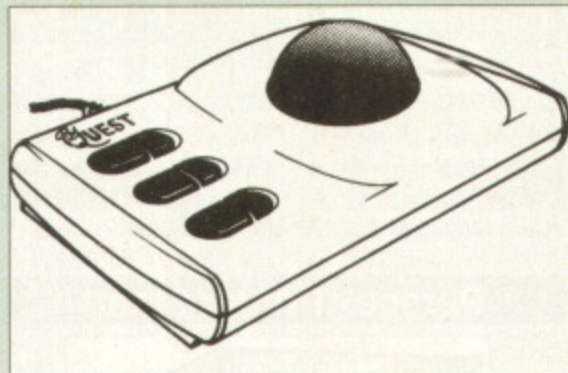

QT-10 BBC/Master Version £27  
QT-20 Archimedes Version £30

## RB2 Marconi TRACKER BALL

RB2 (AMX/Quest compatible) £45  
RB2 including Quest Paint £75  
RB2-A for Archimedes £46

## THE NEW Mk III AMX MOUSE

Inc. Super Art package

ONLY: £59 (carr £3)

(Please specify for BBC, Master or Compact)

MOUSE MAT	£3
AMX MOUSE ONLY	£29
AMX SUPERART Package	£34
AMX STOP PRESS – A Desktop publishing software. Works with Keyboard, Joystick or a mouse	£32
PAGE-FONTS – Over 20 Fonts for use with AMX Pagemaker	£13
AMX DESIGN (ROM)	£55
AMX XAM Educational	£15
AMX EXTRA EXTRA	£16
AMX MAX A gem of desktop (ROM)	£20

## WE Mouse House

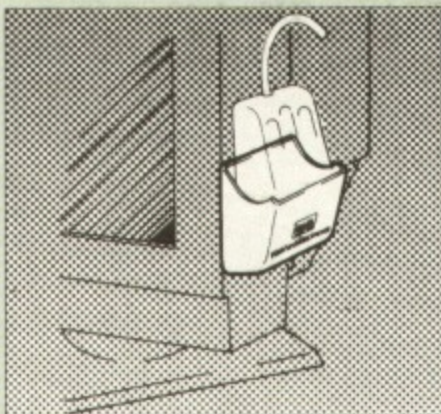

Treat your mouse to a cosy Mouse House. This handy little gadget solves the problem of where to store your mouse when it is having a rest. Made of sturdy plastic, the WE Mouse House attaches to the side of your computer, monitor, disc drive or desk.

It protects it from damage when not in use, yet within easy reach when you need it again. At £4 it does not cost a rodent's ransom.

Price £4



Our Mark II Light Pen is the very latest in light pen technology. It is totally insensitive to local lighting conditions and works with many different monitors. The pen only responds to the High Frequency light produced by your monitor/TV. An LED indicates when valid video data is being produced. A conveniently located switch is also fitted. (Price includes FREE software Disc and Operating Manual)

Only £21

## FLEET STREET EDITOR

Software pack for BBC Micro	£33
Software pack for the Master	£39
Admin Xtra Disc Utility	£13
Fonts N Graphics Disc Utility	£13

## BEEB VIDEO DIGITISER



"Test Bureau Approved for Use in Education"

Using any source of composite video (colour or monochrome) and the Watford Beeb Video Digitiser, you can convert an image from your camera into a graphics screen on the BBC Micro. This uses the full graphics capacity of the BBC micro in modes 0, 1 or 2. The video source may be a camera, video recorder or television, and is connected via the video output socket. The software supplied includes a sophisticated, fast screen dump routine.

Images produced can be compressed, stored to disc, printed on an Epson compatible printer, directly used to generate graphics, analysed for scientific and educational use or converted to other formats e.g. Slow Scan TV or receiving a picture from a remote camera using a modem. The output from the digitiser exactly matches the graphics capability in each mode, with up to 8 levels of grey in mode 2. The unit connects into the User Port and automatically scans a complete picture in 1.6 seconds.

£109 (Carr. £5)

(BBC B+ and Master compatible, except Master with Econet)

(Price includes) Digitiser Unit, Software in ROM & a Comprehensive Manual)

## The Beeb HandScan

Hand-held Scanner for the BBC Micro



Watford Electronics are pleased to announce the launch of the first hand held scanner for the BBC Micro. HandScan is a compact unit which will allow photographs, diagrams, or any other documents to be digitised quickly and easily, to then be used in a desk top publishing package, art program, or even in your own Basic programs! These useful devices have been available for faster and more expensive micros for some time, but only now is Watford Electronics able to offer the BBC Micro computer. The HandScan plugs directly into the 1MHz bus on the BBC while a comprehensive set of utilities provided by the sophisticated ROM firmware. The scanner has a resolution of either 100 DPI or 200 DPI when accuracy is essential. Pictures as wide as 4" may be scanned in mode 0 and various types of dithering may be selected to simulate the grey levels of a scanned picture.

All necessary software has been included in the firmware to allow the scanner to read images directly into our Wapping Editor with little more than the click of the mouse. The digitised picture may then be incorporated into your magazine, newsletter, report or any other document.

Beeb HandScan & Firmware £135



Winner of the BBC Acorn User 1990  
Award for the Best DTP/Word Processor

## The Wapping Editor

The Wapping Editor from Watford Electronics represents a breakthrough in Desktop Publishing for the Beeb. The package includes a 64K ROM containing ALL the software needed to get into print fast; a very sophisticated graphics module, professional quality typesetting software, a word processor, a comprehensive font editor for designing your own typefaces, and a variety of printer dumps. This mouse-driven system is designed for the BBC B, the B+ and Master computers and will take full advantage of any Sideways and Shadow RAM that may be fitted. It will run under DFS, ADFS and Network filing systems and requires as a minimum just a single 40 track drive.

Included with the system is a utility disc containing several high quality fonts, various utilities and a ROM image of a Support ROM. A comprehensive 100 page manual completes the package. The Support ROM contains routines to allow an area to be rotated to any angle or distorted to any four-sided shape. Also included are facilities to draw ellipses at any angle and sectors, segments and arcs (in Master or BBC B with Acorn GXR). Another of the features of the Support ROM is a 'Turbo DFS' which gives DFS access times comparable with those of ADFS.

## Page Layout Section

The Wapping Editor may be used to create pages of any size from an A6 to a full A3 page. If none of the eight default page types suit your purpose, the stand-alone page creation program may be used to create pages to your own requirements. By using proportionally spaced fonts and genuine microspacing it is possible to print over 150 characters across an A4 page. A unique feature of the Wapping Editor is the 'A5 x 2' page size allowing two A5 pages to be printed side by side onto a single A4 sheet.

The graphics module incorporates the facilities like: pencil, brush, airbrush, polygon, circle, eclipse, fill, cut & paste, etc.

Text may be typeset, either justified or unjustified, in any font anywhere on the page. Simply select which font and text document you wish to use, and pull out a rectangle on the page where you want the text to be - it's as simple as that! Multiple columns may be printed just as easily and a special 'expand' feature may be used to expand the microspacing so that the document exactly fits the space defined.

## Word-Processor

The integral word processor is the ideal tool for producing your text documents, although text can of course be read in from any of the other popular word processors such as View, Wordwise etc.

## The Font Editor

The font editor module will allow you to design your own typefaces or to modify the ones provided on the utility disc. This sophisticated editor has numerous functions designed to take the tedium and frustration out of producing good looking, well balanced fonts. Each character may be individually proportionally spaced and characters of any size up to 16 x 16 pixels may be defined.

Pictures may also be 'grabbed' from a video source by using the Watford BEEB Video Digitiser.

Wapping Editor Software Pack £69  
Wapping Editor plus Mouse £89

(Wapping Editor only works with Master Compact if a Mertec Expansion box is fitted)

NEW

At the request of many of our customers we are now able to offer training in the use of Wapping Editor DTP package. For further information please telephone 0923 37774 and ask for Tim or Shiraz

## Wapping Art Disc

Over 250K of clip art to cut and paste into your Wapping Editor pages. Pictures include maps, transport, people, media, sport, games etc. Two 'ratio' screens for use with hi-res and rotated A5 pages to ensure images are not distorted when printed out.

Music writing symbols in the form of pattern and brush for quick production of manuscripts are included together with staves.

There are two prepared hi-res pages laid out for printing labels, both single and double width. Ready made label designs are included but these can be easily replaced with your own designs.

A Mode 0 screen dump routine is also included. To pack such a large amount of data onto the discs the screens have been compressed and routines to compress and expand Mode 0 screens are included on both discs. Using the packing routine you can archive large numbers of screens onto a single disc.

£15

## Wapping Font Disc 1

Sixteen additional fonts, including smaller version of Oberon and Daisy and two new sizes of the standard font for the Wapping editor. Also included are three Mode 0 screens containing giant 'headline' fonts to cut and paste to create extra smooth headlines. Supplied complete with instructions.

£12

## Wapping Font Disc 2

This new addition to our Wapping range of DTP software provides you with additional 23 fonts for the Wapping Editor DTP pack. (80 track discs only).

£13

## Laser Direct



By using the power of the Archimedes RISC processor, it offers the best of both worlds - print speed up to 5 times faster than typical Laserjet compatibles - uses outline fonts so that any font can be scaled to any size - works with all programs that use RISC OS printer drivers. Ideal for use with Genesis, !Draw, Acorn DTP, Impression, etc. Includes 50 sheet paper tray and a single sheet/envelope tray. Requires one expansion slot and at least a 2Mbyte Archimedes. A very compact printer, a very low initial cost and very low running costs.

Special Price: £849

- Special High Res Laser Direct Card 600 DPI for Canon LPB4 Laser Printer £325
- LPB4 Printer plus High Res Card £1025

(For demonstration, call in at our retail shop)



CREDIT CARD 24 HOUR  
Ansaphone Hot Lines  
(0923) 50234 or 33383

All prices are exclusive of  
VAT

## Archi Mk II Hand Scanner

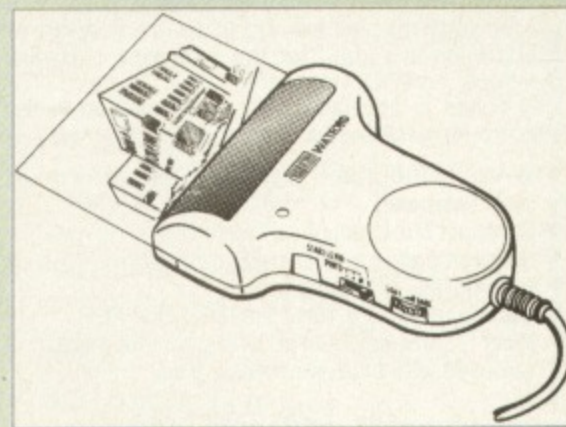

Watford Electronics is now able to offer a complete hand held scanning package, possibly the most essential addition to any desk top publishing system, for only £149. The package includes the most comprehensive utility software available for the Archimedes, a high quality hand held scanner, and all necessary documentation to get you going straight away.

## SCANNER

The scanner is capable of scanning up to an amazing 400 dots per inch (DPI)! The scanning area is 4" wide, and the height is only limited by the maximum amount of memory available. The dot resolution may be switched to 100, 200, 300 or the maximum 400 dpi. One of four operating modes may be selected offering either pure monochrome scanning, or one of three grey level modes. The grey level modes use different size dither patterns to represent up to 16 shades of grey. There is also a dial to allow the "brightness" to be adjusted over a wide range, in order to optimise the quality for any specific image. The scanner interface is a standard, single width, expansion card (podule) which plugs into the Archimedes' backplane. The socket on the rear panel connects the scanner by 1.8 metres of cable.

## SCANNER SOFTWARE

Full use is made of the windowing and the multi-tasking facilities of RiscOS. The software is supplied in a 64Kbyte ROM located on the interface board. The scanner appears as a small icon on the desktop icon bar, and the software is retrieved from the ROM simply by clicking on that icon. As you scan a page, the image appears in the scanning window on the screen, scrolling up in real time. The other facilities included in the software are:

Cropping and scaling to any size including stretching and squashing in X and Y direction separately.

Colour tinting.  
X and Y flip.

Edge detection which turns solid objects into outlines.

Selective directional copying which allows features (i.e. lines or text) to be made thicker or thinner.

Scanned images may be saved as sprite files or transferred directly into other RiscOS applications (DTP, Draw, Paint) simply by dragging the sprite file into the application's window. Sprites may also be generated using anti-aliasing. This greatly improves picture quality and is particularly effective when scanning material with a range of grey tones, such as photographs. Images can be printed on any printer that is supported by a RiscOS printer driver, with optional settings for portrait or landscape modes, image scale and positioning. Images are printed using the full resolution of the printer and are not limited to the screen resolution.

On-screen help is provided via the RiscOS interactive help facility. Calls are also provided in the ROM for users wishing to write their own software, incorporating the use of the scanner.

AHS-4 Archi 300/400 Version £149

AHS-3 Archi A3000 Version £175

Continued → → → → → → → → → →

## 16K Disc Ram Module

(16K Sideways RAM Module)

Complete with such features as read and write protection, these new modules from Watford Electronics are ideal for the hobbyist, software developer and ROM collector.

Key points to note about this new addition to the Watford range of products are:

- Write protection (useful in a variety of circumstances)
- Compact construction
- No overheating or overloading problems.
- Free utilities disc supplied
- Can be used as a 16K PRINTER BUFFER.
- Ideal for professional software development.
- Supplied with utilities software disc.

Only: £29 (carr £2)

Optional Battery back-up fitted

£3

## Solderless Sideways ROM Socket Board

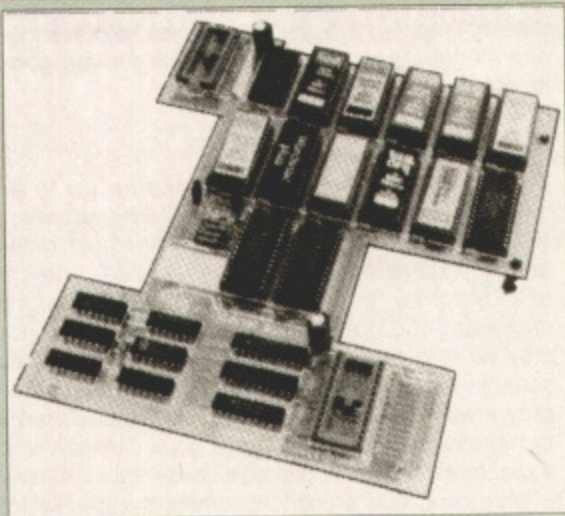

The key features of this new, no fuss, easy to install quality product from BBC leaders Watford Electronics are as follows:

- Increase your BBCs capacity for ROMs from 4 to 16.
- **No soldering required.**
- Very low power consumption.
- Minimal space required.
- Compatible with Torch, DDFS, RAM Card, 2nd Processor, etc.
- Socket 14 takes two 6264 RAM chips.
- Read protect to make RAM "Vanish") allows recovery from ROM crashes.
- Battery backup option for RAM chips.
- Supplied ready to fit with comprehensive instructions.

Price: Only £35

Battery Backup fitted £39

Battery Backup only £3

16K Sideways RAM £8.50

(carriage £3)

- Sideways RAM Utilities Disc for Solderless ROM Board. Includes the options to load and save ROM Images and the facility to use Sideways RAM as Printer Buffer.

Only: £8

## User Port Splitter Unit



Gone are the days when you had to plug and unplug devices from the User Port. This extremely useful little device allows two units to be connected to the User Port simultaneously, and select between them simply by toggling a switch. This device is particularly useful for those people using Quest Mouse and the Watford Video Digitiser or any similar combination

Excellent Value at £22 (carr £2)

## Sideways ROM ZIF Socket System

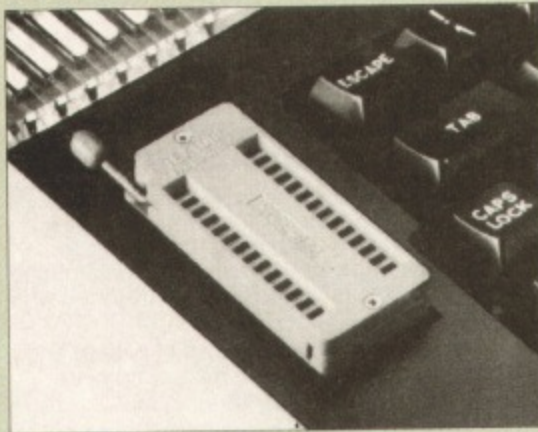

Allows you to change your ROMs quickly and efficiently, without opening the lid. The ZERO INSERTION FORCE (ZIF) socket is located into the ROM Cartridge's position.

- Very simple to install. NO SOLDERING required. The ZIF (Zero Insertion Force) eliminates the possibility of damage to your ROM pins when inserting & extracting.
- The low profile of the socket allows unrestricted access to the Keyboard.
- All data and address lines are correctly terminated to ensure correct operation of suitable ROMs with the BBC micro. We also supply a purpose designed see-through storage container with anti-static lining, allowing you to store up to 12 ROMs, protecting them from mechanical and static damage.
- This versatile hardware solves the problem of running out of socket space. Simply lift the ROM from the ZIF & insert a different one (No pulling or pushing of Cartridges. It is a must for professionals and Hobbyists alike.)
- BBC, B and B+ compatible.

ONLY £18 (carr £3)

## BBC B Low Profile Cartridge System

Complete System consists of: Low profile ROM Cartridge, Socket housing, Cable assembly, 5 labels and a library storage rack for the BBC B.

- Complete System £11
- Spare Cartridges £2.75
- Spare Rack £1.65

## ROM Cartridges for the BBC Master

Will accept the new larger Piggy Back ROMs like: Interword, Interbase, Quest, Conquest, etc

Twin £9; Quad £14

## Commander Joystick

Watford Electronics' new Commander Joystick for the BBC B and Master 128K has a unique dual mode of operation giving selective free floating or self centring fully variable control in both X and Y axis directions. Commander is particularly good for flight simulation and drawing programs.

Features:

- Direct connection to BBC Analogue input port – no interface needed.
- Fully compatible with all BBC Joystick controlled games programmes.
- Switchable springs allow selection of floating or centring operation.
- Trim adjusters for both X and Y axes for fine centre adjustment.
- Convenient stick mounted fire button with additional base buttons.

Launch Price: £15



## ARIES CORNER

### B-32 Shadow RAM Card

Like the BBC B+, the B32 provides 20k of shadow screen RAM and 12k of sideways RAM. Unlike the B+, the B32 has simple software commands which allow the user to reconfigure the RAM as 16k of shadow RAM and 16k of sideways RAM, or all 32k as sideways RAM.

With the B32, the programmer gets up to 28k of RAM available for Basic, Logo, Cobal, Forth, Lisp and BCPL programs in any screen mode. The business user gets extra memory for View, ViewSheet, Wordwise Plus, Interword and many other applications. For advanced applications, the scientific user gets access to a massive 47k of data storage using the Acorn approved ★FX call.

Sideways RAM enables you to load sideways ROM images from disc, allowing you to have a large library of sideways ROMs (subject to the copyright holder's permission) stored on disc. The B32's sideways RAM can also be used to extend any operating system buffer (such as the printer buffer) or to load tape programs into a disc system.

The B32 simply plugs into the 6502 processor socket on your BBC micro – no flying leads to connect and no soldering. Provision of the onboard ROM socket means that the Aries-B32 control ROM does not use up one of your existing ROM sockets.

- Recommended by Computer Concepts for use with their Inter series of ROMs.

Price: £69 (carr. £3)

### Aries B-12 Sideways ROM Board

The B-12 provides a total of twelve sideways ROM sockets (the four in the original machine are replaced by the twelve on the board), all fully accessible by the MOS sideways ROM system. In addition, there are two sockets for sideways RAM, giving up to 16k of RAM using 6264 static RAM chips.

If you do not have a B32 or B20, a small adaptor module (the Aries-B12C) is available at a nominal cost

Price: Aries B-12 £36  
Aries B-12C £5

### Aries B-488 IEEE-488 Interface Unit

The Aries-B488 is an interface unit to enable the BBC micro to control and monitor IEEE-488 bus systems. The IEEE-488 bus (also known as the 'GPIB' or 'HP IB') is the standard method of interconnecting programmable laboratory instruments and control equipment. Using the B488, up to 15 devices may be connected in a single high-speed data network.

£238 (Carr £3)

### Voltmace Joysticks

Delta 3B Single Joystick	£10
Delta 3B Twin Joysticks	£15
Delta 3C Joystick for Compact	£10
Delta 14B Single Joystick	£11
Delta 14B/1 Adaptor Module	£12
Transfer Software Disc-Tape	£7
Delta-Cat A mouse eliminator Joystick for the Archimedes	£24

### Delta Base B



Analogue aircraft style yoke Joystick to run in the analogue port of the BBC B & Master 128

£25

## ROM/RAM Card

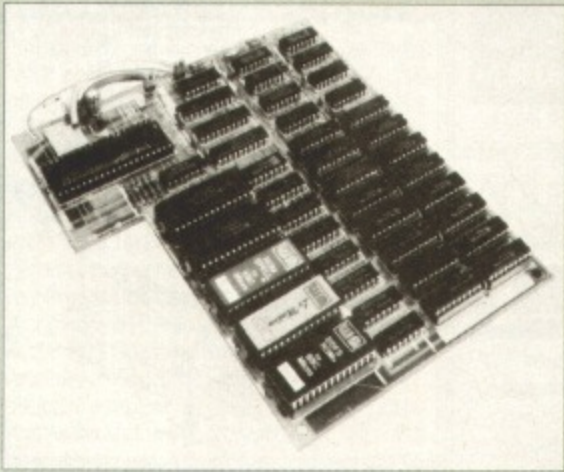

Watford Electronics announced the first ever commercial ROM board for the BBC micro, the Watford Electronics 13 ROM Socket Board 7 years ago. Following the success of this board, we have designed what probably represents the ultimate in expansion boards, the new Watford Electronics ROM/RAM board. This highly versatile and sophisticated board represents the latest in "2nd generation" sideways ROM technology for the BBC micro, designed to satisfy the serious BBC user.

- NO SOLDERING required to fit the board.
- NO User Port corruption (avoids problems with the mouse, modems, Eprom Programmers, etc.)
- Fully buffered for peace of mind.
- Compatible with BBC micros (not BBC+ or Master).
- Total number of ROMs increased from 4 to 8.
- Up to 8 banks of sideways RAM (dynamic).
- Option for 16k of battery backed CMOS RAM (CMOS RAM needs one ROM socket).
- Software Write protect for ALL RAM.
- Read protect for CMOS RAM (ALLEVIATES crashes during ROM development).
- Separate RAM write register (&FF30 to &FF3F).
- Automatic write to currently selected RAM socket for convenience.
- FREE utilities disc packed with software.
- Compatible with our DDFS board, 32k RAM Card, Delta Card, sideways ZIF, etc.
- Large printer buffer.
- UNIQUE fully implemented RAM FILING SYSTEM (similar to the popular Watford DFS).
- ROM to RAM load and save facilities.

The SFS (Silicon Filing System) can utilise up to the full 128k of RAM (with the SFS in any paged RAM) as a SILICON DISC. This behaves as a disc drive, with all the normal Watford DFS features (including OSWORD &7F for ROMSPELL, etc.) to provide an environment that looks like a disc but loads and saves MUCH faster.

The ROM-RAM Board plugs into the 6502 CPU socket. This leaves free all the existing ROM sockets, which can still be used normally.

Any ROM that can be plugged into the BBC micro's own ROM sockets may be used in the ROM-RAM Board.

The ROM-RAM Board is supplied with all ordered options fitted as standard. Upgrade kits (with full instructions) are available for all of the options, for later.

### PRICES:

- ROM/RAM card with 32k dynamic RAM **£48**
- ROM/RAM card with 64k dynamic RAM **£65**
- ROM/RAM card with a massive 128k dynamic RAM **£109**  
(carriage on ROM-RAM Card £3)

### OPTIONAL EXTRAS:

- 16k plug-in Static RAM kit **£9**
- 16k Dynamic RAM for Upgrade **£13**
- Battery backup **£3**
- Read and Write protect switches **£2 each**
- Complete ROM-RAM board **£115**
- All options installed **£115**

### P.S.

IS your existing ROM Board overflowing with ROMs? Do you need more Sideways RAM? Is your Board unreliable? Then upgrade to Watford, ROM/RAM Board and pay £5 less.

## 32K Shadow RAM/Printer Buffer Card Expansion Board

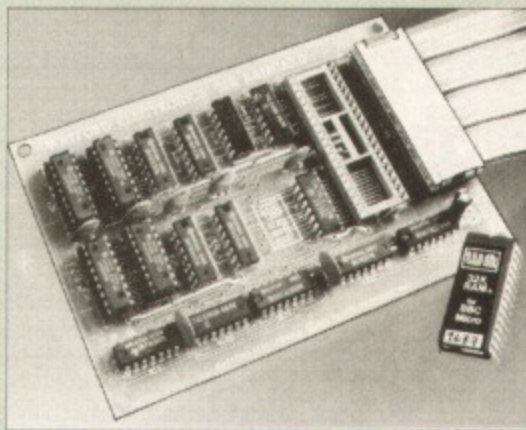

### A MUST FOR WORD PROCESSING

Don't throw away your BBC B for a BBC B Plus or BBC Master. Just plug the ribbon cable into the 6502 processor socket, and fit the compact board inside the computer. Immediately you will gain not 16k or even 20k, but a massive 32k of extra RAM!!!

• IMPROVE your WORD PROCESSING system, whether disc or cassette based. Don't wait for a slow printer - type in text while printing. TWO JOBS DONE SIMULTANEOUSLY and £100+ saved on a printer buffer.

• "VIEW" Wordprocessor users can now type in letters in 80 columns and have up to 28,000 bytes free - 5 times as much as normal.

• In WORDWISE (or WORDWISE-PLUS), preview in 80 columns with the full 24k of text in memory. This product is recommended as an ideal complement by Computer Concepts.

• Combine GOOD GRAPHICS and LONG PROGRAMS. Use the top 20k of the expansion RAM as the screen display memory, leaving all the standard BBC RAM free for programs. Benefit from MODE 0/1/2 graphics and 28k of program space.

• Use the FULL 32k or the bottom 12k of the expansion RAM as a PRINTER buffer for PARALLEL or SERIAL printers, sound channels, RS432 etc. Print large text files while running long graphics programs, and have all your buffer options available as well (\*FX15,21,138, 145,ADVAL etc). Please note only a 12k printer buffer can be used with Wordwise or Wordwise-Plus, due to the way they are written.

• Unique facility to turn ROMs off and on again. Unlike all other ROM managers, this feature does not use 'unofficial' memory. Two bytes of normally user-inaccessible memory on the RAM card are used to ensure ROMs are disabled WHERE OTHER ROMS FAIL.

**Only £59** (carr £3)

(Price includes a comprehensive manual and the ROM)

## BBC SOFTWARE'S Popular Educational Software

- Maths with a Story 1 (Disc). 4 primary level maths programs **£20.00**
- Maths with a Story 2 (Disc). 4 further maths programs. **£20.00**
- Picture Craft (Disc) 6-14 age group. Pack consists of flexible geometrical design & colouring programs. **£17.00**
- ECOLOGY O-Level program. **£20.00**
- POLYMERS O-Level program. **£20.00**
- Classification & Periodic Table O-Level. The suite is supplied with its own database of chemical elements which can be classified according to your own rule. **£20.00**
- ADVANCED TELETXT SYSTEM **£8.65**
- PERIOD TABLE SOFTWARE **£20.00**
- Computers at Work - Primary **£17.35**
- Introducing Geography 11-17 years **£17.50**
- Electric Fields 6-14 years **£11.25**
- Espana Viva - 3 Discs **£19.95**
- WHITE KNIGHT Chess game **£16.00**
- A Vous La France **£29.00**

## More Educational Software

- **FUN SCHOOL 2 - Red:** Under 6 yrs - 8 programs on Discs, Shape Snap, Find the Mole, Teddy Count, Write a Letter, Colour Train, Pick a Letter, Spell a Word & Teddy Bears Picnic. **£12.00**
- **FUN SCHOOL 2 - Green:** 6-8 yrs - Eight programs on Disc, Number Train, Shopping, Maths Maze, Treasure Hunt, Bounce, Packing Caterpillar, 3 Number jump **£12.25**
- **FUN SCHOOL 2 - Blue:** Over 8 yrs - Eight programs on Disc, Build a Bridge, Passage of Guardians, Unicorn, Logic Doors, Souvenirs, Code Boxes, Mystery Machine & Escape. **£12.50**
- **FUN SCHOOL 3 - Red** **£19.95**
- **FUN SCHOOL 3 - Green** **£19.95**
- **FUN SCHOOL 3 - Blue** **£19.95**
- Six French Games - Aimed at pupils in their first year of French, but also useful as revision for more advanced students 11 years+ **£26**
- More French Games - Another 6 games 12 years+ **£26**
- Au Restaurant and Accident de Route 12 years+ **£26**
- Boulogne and Oh-Les - 2 programs for beginners **£26**
- Letters to French Penpals - 11 years+ **£26**
- French Programs with Henri Beret - The programs in this series present vocabulary, grammar and role-play phrases in the form of animated games. 11-16 **£22**
- Six German Games - Aimed at pupils in their first year, but useful as revision for more advanced student of German. 12 years+ **£22**
- More German Games - Aimed at pupils in their 2nd year of learning German. 12 years+ **£22**
- The Cloze Program - Using context clues to predict is much more than a gap filling exercise. All ages **£26**
- An Introduction to Electronics - Brings together all the basic electronics required for a GCSE Physics or CDT course. 14-16 years **£26**
- Computer Control - This is a package of 3 programs simulating control of a greenhouse, a robotic arm & a chemical plant. 14-16 years **£26**
- The Nuclear Reactor - An interactive, menu driven program for GCSE pupils. Demonstrates & explains nuclear fission & the chain reaction. 14-16 years **£22**
- PUNCMAN Learning punctuation  
Puncman 1 & 2 for 7 - 13 years **£15**  
Puncman 3 & 4 for 8 - 14 years **£15**  
Puncman 5 & 6 for 8 - 15 years **£15**
- Yes Chancellor - A chance to take over number 11 at Downing Street. 12 years+ **£18**
- Letters & Pictures - Introduces phonic skills to Infants 6-8 years **£15**
- Numbers & Pictures - Early number learning is a great fun (4-6 years) **£15**
- Note Invaders - Budding musicians can learn the notes on the Clef with this elegant game 3 programs (7 to Adults) **£15**
- Maps & landscapes No. 1 (9-14 years) **£18**
- Help Your Child learn Basic Map work No. 2 (9-14 years) **£18**
- Pirate - Educational Adventure (8-14 years) **£15**
- Spelling Week by Week (6-14 years) **£18**

## Archimedes Software

- Bookbinder **£43**
- BUMPER DISC **£14**
- Bumper Disc 2 **£14**
- Craftshop 1 **£26**
- Craftshop 2 **£26**
- Desktop Stories **£27**
- Fun School 2A Red (up to 6 years) **£12**
- Fun School 2A Green (6-8 years) **£14**
- Fun School 2A Blue (8 years +) **£14**
- Gate Array Teaching System **£68**
- DigiSim **£35**
- Droom **£17**
- Jiglet **£27**
- Jigsaw **£28**
- Numerator **£60**
- Snippet **£26**

Continued → → → → → → → → → →

### Computer Concept's ROMS

Communicator	£49
Disc Doctor	£28
Inter BASE	£49
Inter CHART	£25
Inter SHEET	£37
Inter WORD	£36
Mega-3 ROM	£76
Spell Master	£42
TERMI	£25
Wordwise	£24

### Wordwise plus

£40

We are giving away absolutely **FREE**, the superb Word-Aid ROM worth £24, with every WORDWISE PLUS package bought from us.

### Word-Aid

The most comprehensive utilities ROM for Wordwise-Plus

Extend the power of your Wordwise Plus word processor with this most advanced ROM from Watford. By utilising the powerful Wordwise Plus programming language, WordAid provides a whole host of extra features, all accessed via a special new menu option. This ROM has been personally approved by Mr Charles Moir, the author of WORDWISE PLUS.

- Alphabetical sorting of names and addresses.
- Text transfer options.
- Chapter marker.
- Epson printer codes function key option.
- Search and display in preview mode.
- Embedded command removal.
- Print Multiple copies of a document.
- Multiple file options for print and preview.
- Address finder.
- Label printer.
- Mail-merger.
- Number/delete/renumber.
- Clear test-segment area.
- BBC B, B+ and Master compatible.

Only £24

(N.B. Word Aid requires a Disc interface in your Micro)

### Acorn ROMS

View 3.0 ROM	£45
View Professional	£50
Viewsheets (Acornsoft)	£36
Viewstore	£36
Viewspell with 80 track disc	£25
Viewplot Disc	£20
(Please specify for Master 128 or Compact)	
View-Index	£12
Overview packs 1 & 2	£65
Hi-View	£38

### MINI OFFICE II

DISC Version for BBC B & B+	£14.00
DISC Version for BBC Master	£16.00
DISC Version for the Compact	£18.00

(When ordering please specify for which Micro & 40 or 80 track Disc)

All prices are exclusive of VAT

### View Printer Driver Discs

Epson FX & RX 80	£10
Juki & Brother HR	£10

### View Printer Driver ROM

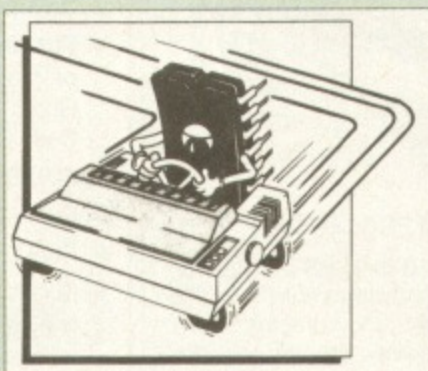

View is a powerful word processor, but it seriously lacks in terms of printer driver support. With the View Printer Driver ROM, the View users will find themselves in the realms of advanced word processing.

The VPD extends View's printer command with a series of mnemonic commands. All standard highlight sequences are also supported. A large range of printers are supported by drivers contained within the ROM (the drivers can be downloaded and customised). Printers supported include: Epson's MX, RX, FX, LX, JX80 range, HI80, KP810/910, PW1080, JP101, HR15, M1009, GLP, Panasonic KX-P1081/2, JUKI 6100, etc.

Other printers are readily supported by defining a Printer Driver using the built-in Printer Driver Generator. The features mentioned below are available to both the built in Printer Drivers and user defined drivers (assuming the printer supports the features).

NLQ control, Underline, Bold, Proportional Spacing, Microspacing, Italic, Superscript, Subscript, Condensed, Enlarged, Double Strike, Set lines per inch numerically (e.g. LPI 6), Set characters per inch numerically (e.g. CPI 5), Select printer font, Select printer ribbon colour, Translation sequences, Emulation of BBC Character Set, Simple numeric expressions for certain operations, Full printer setup, Send control codes, Print prompt on screen, Redefinable Pad character, Pause for key press, Prompt to change daisywheel, and Execute ★ command when printing.

Other features include a very powerful on-screen preview, with bold, italic, underline, super/subscript, enlarged highlights, and a special printer driver to allow memory-based text to be previewed by View 1.4. Of course, View 1.4, 2.1 and 3.0 are all supported, as is Shadow RAM and 6502 Second Processors. The BBC B series and Master series of micros are supported. A comprehensive manual is supplied. All in all, a very professional product for the discerning user who wants power at their finger tips.

Price: Only £33



CREDIT CARD  
24 HOUR



Ansaphone Hot Lines  
(0923) 50234 or 33383

### OFFICE MASTER



**CASHBOOK** – A complete "Stand Alone" accounting software package for the cash based sole trader/partnership business. It is designed to replace your existing cashbook system and will provide you with a computerised system complete to trial balance.

**FINAL ACCOUNTS** – Will take data prepared by the Cashbook module and produce a complete set of accounts as following: Trial Balance with inbuilt rounding routine; Notes to the accounts; VAT Summary; Profit & Loss A/C; Balance Sheet.

**MAILIST** – A very versatile program. Enables you to keep records of names and addresses and then print, examine, sort and find them, all with special selection techniques.

**EASILEDGER** – A management aid software tool designed to run alongside an existing accounting system. Essentially a Debit/Credit ledger system which can handle sales, purchase and nominal ledger routines to provide instant management information.

**INVOICES & STATEMENTS** – Greatly reduces the time and cost of preparing Invoices and Statements by storing essential information like customer names, addresses and account numbers. Has VAT routines and footer messages facility.

**STOCK CONTROL** – Allows you to enter stock received, stock out, summary of stock items and current holdings together with details of total cost, total stock to minimum level, units in stock ordering, quantity and supplier detail.

All this for only £21 (Disc)

### OFFICE MATE



- DATABASE
- BEEBCALC SPREADSHEET
- BEEBPLOT GRAPHICS

**DATABASE** – Set up a computerised card index system with powerful search facilities.

**SPREADSHEET** – Offers many calculation and editing features

**BEEBPLOT** – Provides visual representation from Spreadsheet data.

Only £10 (Disc)

Acorn Speech Synthesizer package complete, for the BBC B Microcomputer

Special Offer £14

### Copy Holder

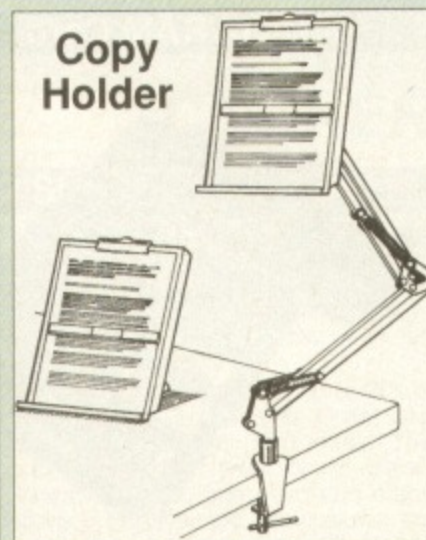

Whether you want to type in your latest program or the draft of a new trilogy, Watford's manuscript holders are superb for holding your paper at the ideal height and angle to allow you to read and type in ease and comfort.

Available in 2 full A4 versions, desk resting and shelf clamping. Paper is held firmly by means of a plastic retaining ruler and a clip grip. (for resting books or magazines, the desk top version is recommended).

Desk Top £7 (carr. £3)

Angle poise £12 (carr. £3)

### The Epson RX/FX/KAGA Printer Commands Revealed Handbook

#### Printer Commands Revealed

So you bought yourself a new printer, because the salesman in the shop showed you how clever it is and impressed you with all sorts of printouts to show its capabilities – he may even have offered you a special price.

However, now that you have got it home and connected it to your BBC microcomputer, you are wondering how to make it perform these magical tasks. The manual seems to give no clues, and when you type in the example programs, the computer throws the LPRINT statements back in your face.

Now what do you do, when this £400 piece of high technology refuses even to move its head, and you have stayed up until 2 in the morning with copious supplies of coffee, desperately trying to print something out? Once again, Watford Electronics comes to your help with our new book entitled 'THE EPSON FX-KAGA PRINTER COMMANDS REVEALED'.

This book describes in plain, easy to understand English, how to use and make the most of your KP810, PW1080A or any other Epson FX80 compatible printers like Panasonic KX-P1080/1, etc., with the BBC Micro, both from Basic and Wordwise.

It describes in detail how to obtain the maximum in graphics capability from your printer and includes full indexes allowing you to cross index the numerous commands. Every command is explained in detail, with an accompanying BBC Basic program and an example of its use from Wordwise.

£5.95 (No VAT)

ALL PRICES EXCLUDE  
VAT

## BOOKS (No VAT on Books)

15 Hr Wordprocessing BBC/View	£6.95
15 Hr Wordprocessing BBC/WW & WW+	£6.95
30 Hour BASIC (BBC Micro)	£12.95
1st Word Plus Rel. 2 Manual	£10.00
A3000 Technical Manual	£29.00
Acorn DTP A Guide to	£17.00
<b>Advanced User Guide for BBC</b>	<b>£10.95</b>
Archimedes 1st Step - Beginners Guide	£9.95
Archimedes Assembly Language	£14.95
Archimedes BBC Basic Guide	£20
Archimedes DTP Manual	£10.00
Archimedes Operating System	£14.95
Archimedes Risc-Os Programmers Reference Manual	£79.00
Arm Assembly Lang. Prog. Manual	£15
Assembly Language Quick Ref.	£21.95
BASIC 2 - User Guide	£2
Basic V - A Dabhand Guide	£9.95
BBC Basic Guide (Archimedes)	£19.95
<b>BBC Computer Handbook - The Complete</b>	<b>£14.95</b>
BBC Micro - Within the	£11.95
BCPL User Guide	£9
C Big Red Book of	£8.95
C - A Dabhand Guide to	£14.95
C Programming Lang. 2nd Edition	£24.95
COMAL - Introduction to	£9.50
Deutsch Direkt! (Book only)	£5.95
<b>DISC FILING SYSTEM (DFS) Operating Manual for BBC</b>	<b>£6.95</b>
FORTH on the BBC Micro	£9.95
Hackers Handbook - New	£9.95
ISO-PASCAL Reference Manual	£9.95
Mastering Interpreters & Compilers	£14.95
Master 512 Guide - Dabs Press	£9.95
Master Operating System	£12.95
Master Reference Manual Part 1	£14
Master Reference Manual Part 2	£14
Master Reference Manual - Advanced	£17
Mathematical Programs in BBC BASIC	£9.95
MINI OFFICE II - A Dabhand Guide	£9.95
Mouse User Guide to BBC Micro - the Complete	£5.95
Example Programs on Disc for above	£4.95
PASCAL on the BBC Micro	£9.50
PASCAL Programming	£10.95
RISC Technical Manual 260 pg	£14.95
<b>The Epson FX-KAGA PRINTER Commands REVEALED</b>	<b>£5.95</b>
Understanding Interword - A Beginners Guide	£6.50
View 3.0 User Guide	£10
View Guide (View 2.1)	£5.00
View, Viewsheets & Viewstore - Mastering	£12.95
Viewsheets & Viewstore Dabhand Guide	£12.95
VIEW Dabhand Guide	£12.95
Viewsheets User Guide	£10
Viewstore User Guide	£10
Z88 - A Dabhand Guide	£14.95
Z88 Computing	£9.95
Z88 Magic	£14.95
Z88 Using Your	£9.95

## BOOKS for IBM PC & Compatibles

1-2-3 For Business	£25.95
1-2-3 Mastering Release 3	£22.95
1-2-3 Mastering - 2nd Ed.	£20.95
1-2-3 Quick Reference	£7.95
1-2-3 Special Edition (QUE) - Using	£22.95
1-2-3 Using - Rel. 3	£25.95
8086/8088 Ass. Language Quick Ref	£8.45
8086/8088 Programming the	£17.95
Ability - Using	£12.95
Accountancy software in Business - Using	£14.95
Agenda - Using	£21.95
Aldus PageMaker - Using	£21.45
Amstrad 1512/1640 Step by Step - Using the	£POA
Amstrad Basic 2 User Guide	£9.95
Amstrad PC Programmers Ref Guide	£7.50
Amstrad PC1512-1640 Step by Step - Using	£10.95
Assembly Language - Quick Ref.	£7.95
Autocad 4th Ed - Mastering	£31.50
Autocad - Mastering Through Rel. 10	£28.95
Autocad - Using Release 10	£27.95
C Introducing	£12.95

C Programming Language 2nd Ed	£26.95
Clipper - Using	£22.95
Computer Users Dictionary	£9.95
Corel Draw Quick Ref Thru V1.2	£7.95
Corel Draw made easy	£24.95
dBase III Plus - Complete Reference	£19.95
dBase III Plus Handbook 2nd Edition	£22.95
dBase Instant Reference (III & III+)	£10.95
dBase IV - Handbook	£21.95
DOS & BIOS Function - Quick Ref Guide	£7.95
DOS Instant Reference (up to 3.3)	£6.95
DOS Power Tools (includes a disk)	£45.95
DOS - Programmers Ref. Manual 2nd Ed	£25.95
Excel IBM Version - Using the	£22.95
FAX - Managing with	£12.95
Framework III - Mastering	£22.95
GW Basic - Quick Prog. Ref	£8.95
GW Basic Users Guide & Ref	£12.95
Hard Disc management - Quick Reference Guide to	£4.95
Hard Disc - Using Your	£27.45
IBM PC & PS/2 3rd Ed	£21.70
Microsoft GW BASIC	£12.95
Microsoft Windows 3 - Using 2nd Ed	£20.95
Microsoft Word 5 - Using	£20.45
MS-DOS - ABC's of 2nd Ed.	£17.95
MS-DOS Bible 3rd Edition	£24.95
MS-DOS First Book	£15.50
MS DOS for Beginners	£14.95
MS-DOS Quick Prog Ref Guide	£8.95
MS-DOS Masters - Tricks of 2nd Ed	£24.95
MS-DOS - Running 4th edition	£19.95
MS-DOS - Supercharging 2nd Edition	£17.95
MS-DOS Users Guide 3rd Edition	£27.95
MS-DOS - Using	£19.95
MS Windows 3 2nd Ed - Using	£22.95
Netware User Guide	£22.95
Networking Personal Computers 3rd Ed.	£20.95
Norton Utilities - Inside the	£21.95
Novell Network - Mastering	£27.95
Novell Network - The ABC of	£21.95
Novell Network - Using	£22.95
PageMaker on IBM PC - Using	£22.95
Pagemaker - Using	£22.95
PCs & Compatible Computers for Beginners	£14.95
PC Crash Course 2.0 2nd Edition	£19.95
PC Tools - Quick Ref	£7.95
Programming Guide to EGA & VGA Cards	£24.95
Quattro - Mastering	£21.95
Quattro Pro VI - Using	£22.95
Smart - Using	£21.45
Smartware II - Using	£22.95
Smart, tips, tricks and traps (QUE)	£22.95
Supercalc 5 - Using	£27.50
Supercalc Professional	£17.95
Symphony Made Easy	£19.95
Symphony - Using Special Ed.	£27.45
Symphony 4th Edition - Mastering	£24.95
Timeworks Publisher Companion	£12.95
Turbo C Bible	£27.95
Turbo C++	£22.95
Turbo Pascal 5 - Using	£22.95
Turbo Pascal - Advance Techniques in	£20.85
Unix - Using	£27.45
Upgrading & Repairing PC's	£27.45
Ventura Mastering - 2nd Ed.	£22.95
Ventura Publisher - Using	£22.95
Ventura - Instant Reference	£10.95
Ventura - Tips & Tricks 2nd Ed.	£24.95
Window Programming 2nd Ed	£27.95
Window 3.0 Programming	£27.95
Window 3.0 Quick Ref.	£7.95
WORD for Windows - Using	£22.95
Wordperfect 5 - Using	£24.95
Wordperfect - Quick Reference V5	£8.95
Wordperfect 5.1 - ABC's of	£18.95
Wordperfect 5.1 - The ABC of	£7.50
Wordperfect 5.1 - 1st Book of	£14.95
Wordperfect 5.1 - Mastering	£24.95
Wordperfect 5.1 Quick Start	£18.45
Wordperfect 5.1 - Using Special Ed	£22.95
Wordstar & CPM Made Easy	£15.75
Wordstar Using 5.5 & 6 3rd Ed	£25.95
Wordstar 6.0 Made Easy	£19.95
Wordstar 6.0 - Using	£25.95

Carriage on Books vary between £2 to £3.50, depending on their weight

## New Release ACORN TO PC Stop the Confusion!

Do you have to use both Acorn computers and PC's? Would you like to use your Archimedes or A3000 in PC-emulation mode but are unsure of the new commands?

Although Acorn machines (such as the BBC B, the Master, the Archimedes and the BBC A3000) are mainly used in education, most commercial computers use other operating systems, particularly MS-DOS. As a result school computer users are at a disadvantage when moving into 'business' computing. PCs and other commercial computers use MS-DOS as the operating system, so commands for formatting, copying, backing up, printing and the modem are not the same. Even file names are written differently! And did you know that there is one Acorn command which, if used in MS-DOS, wipes everything in the current directory?

'ACORN TO PC' enables you to change over painlessly. It shows clearly and quickly how, why and where the two systems (Acorn and MS-DOS) differ. As with a foreign language dictionary, you can use the book to transfer either way - from Acorn to MS-DOS, or from MS-DOS to Acorn. 'ACORN TO PC' also acts as a handy reference guide to all Acorn star commands and their MS-DOS equivalents. It also has an extensive and readable explanation of the directory tree and hierarchical filing systems in general. Both DFS and ADFS Acorn systems are covered.

'ACORN TO PC' is written clearly and concisely by Dr. John Lockley, who has wide experience of writing and broadcasting. He is currently appearing as a regular contributor on Radio 5, and is co-author of 'The Complete BBC Computer User Handbook'.

**Price: £15.95 (No VAT)**

## The Complete BBC Computer User Handbook

If you own a BBC B, B+, Electron, Master 128 or Master Compact, or Archimedes, then this is the book for you. It shows how to get the best from your machine, and how to make it work for you. The general style and level of presentation means that both the expert and beginner alike will feel comfortable with the quality and quantity of the material. Subjects covered include the general use of computers, hardware design and peripheral devices like printers, disc drives, etc., and Networking. Programming hints and tips and various disciplines for making a better program are discussed in some detail, including debugging of specific errors. Standard programs are covered, such as wordprocessors, spreadsheets, databases, graphics, communications, etc., which brings you neatly on to the subject of using computers in the office or at work - even giving advice on writing and marketing your own programs.

A book you will enjoy to use as a reference, or read from cover to cover, over and over.

**Only: £14.95 (No VAT)**

## The Complete Mouse User Guide to BBC Micro

This manual has been written to reveal the secrets of the mouse. It explains all the principles required by the hardware and associated software, and also example listings for inclusion into custom programs. The manual first details the basic principles of the mouse and a simple program which uses these principles. This information should be adequate for most applications. However, it is possible to improve the performance of the mouse by expanding on the principles already used in the software. This is again fully explained and an example program given.

It is possible to gain a full understanding of the mouse from this manual. For those not interested in exactly how the mouse functions, complete example programs are also included. These may be typed directly into the micro, without the need for any understanding of the hardware or software involved, enabling the mouse to be used for custom applications.

**Price £5.95 (No VAT)**

**Example programs on Disc £4.95**

## Beeb PC (BASIC)

Beeb PC Basic is designed for program authors wishing to convert programs so that they will run on IBM personal computers. To convert BBC BASIC programs manually can waste days of valuable time with every occurrence of common statements such as PROC, DEFPROC, TAB, having to be changed.

Beeb PC (BASIC) automates many of these changes, and will convert majority of BBC statements that are invalid for IBM BASIC into equivalent acceptable statements. In addition BBC BASIC data files can be converted to IBM BASIC format, with support provided for all BBC data formats: - INTEGER, REAL & STRING.

**Price: £38**

## Beeb DOS 3.0

**(Now reads Archimedes Discs)**

The BBC and IBM PC's are the most popular micros in the UK. The BBC is firmly established in the education sector and the IBM is the industry standard in the business world. The pools of information and applications held on these computers are immense, yet the means of passing information between them are very limited. Beeb DOS provides a practical method of transferring information between these two micros.

Beeb DOS is a collection of utilities which run on the PC's and enable it to read and write information on BBC discs. You can transfer files between your PC's 360K floppy, high density floppy or hard disc and your BBC discs. In addition Beeb DOS allows you to catalogue, format and compact BBC discs and delete, re-name, lock and unlock BBC files, all on PC's. Each Beeb DOS utility is written in IBM assembler and is run directly from PC or MS-DOS. The Beeb DOS utility can be run from floppy disc, hard disc or RAM drive.

Beeb DOS is supplied on an IBM 5.25", 360K disc complete with a comprehensive operating manual. (Will only work on 360K Disk Drives & read only ADFS and Watford DDFS - not DFS).

**Price: £39**

(Please write in for technical literature)

**Continued → → → → → →**

## Panafax Facsimile

Top quality Panasonic Fax machines, at Watford's budget prices. Ideal for Schools, Colleges, Home & Offices. Supplied complete with telephone handset & 12 months on-site maintenance warranty.

- UF120 £339
  - UF121 £349
- (P.S. We stock full range of Panafax)

### Watford Electronics are:

- Acorn Qualified Dealer & Econet Referral Centre
- ARIES PC Dealer/Distributor
- Canon Authorised Printer Dealer
- Cambridge Computer Dealer
- Computer Concept Premier Dealer
- EIZO Monitor Dealer
- Microvitec Appointed Dealer
- NEC Appointed Dealer
- Panasonic Premier Dealer
- Roland Plotter Official Dealer
- Star Printer Premier Dealer
- Taxan Appointed Monitor Dealer
- 3M Media Premier Distributor

## ADDER

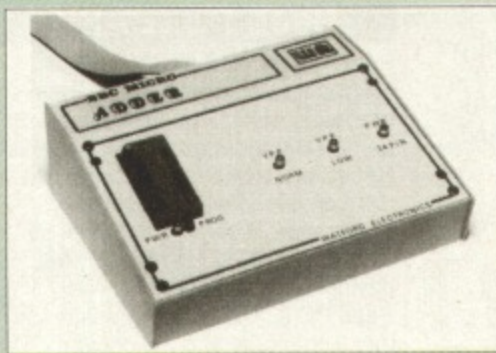

The Adder unit connects to the User Port and draws its power from there too. The EPROM is mounted in a top quality ZIF socket. There are no switches or controls as Adder is entirely software controlled.

The Adder software provides sophisticated facilities for programming EPROMs from a RAM image produced by loading disc files. The software is menu driven and designed for ease of use.

#### Features:

- Two ultra fast programming algorithms or standard slow algorithm.
- Supports standard 21V programming and newer 12.5 volt EPROMs. (Software switched).
- The RAM image to be programmed can be built up in many ways. Sections of image can be loaded separately. Part programming. Read EPROM. Edit data in memory.
- Automatic processing to handle a list of files to program into the EPROM.
- Automatic disc buffering to allow programming of 32K 27256 devices from a 32K file without extra effort.
- Verification gives detailed error list and checksums are maintained. There is also a blank check facility.
- Works with all standard filing systems. Generates header code for RFS ROMs to allow Basic programs etc. to be stored in EPROM. More than one file per ROM permitted.
- Programs the following EPROMs: 2516, 2716, 2532, 2732, 2764, 27128, & 27256.

**£65 (£5 Carr)**

## TEX EPROM ERASERS

EPROMs need careful treatment if they are to survive their expected lifetime. Over erasure of EPROMs very rapidly turns them into ROMs! The TEX erasers operate following the manufacturers specifications to give the maximum possible working life by not erasing too fast.

- **ERASER EB** - Standard version erases up to 16 chips. **£32(carr £3)**
- **ERASER GT** - Deluxe version erases up to 18 chips. Has automatic safety cut-off to switch off the UV lamp when opened. **£35 (carr £3)**
- Spare UV tubes. **£12**



**CREDIT CARD 24 HOUR  
Ansaphone Hot Lines  
(0923) 50234 or 33383**

## Servisol Foam Cleaner

This king size multipurpose foam cleaner spray is ideal for cleaning Keyboard, Monitor, Disc Drive & Computer furniture surfaces.

**£2.50**

## Antistatic Aerosol Spray

Ideal for cleaning and preventing static build-up on TV/Monitor Screens.

**£2.50**

## Aerosol Dust Spray

Ideal for removing dust & dirt from Keyboard & similar inaccessible spaces.

**£3**

## Spares for BBC Micro

UHF Modulator	£4	16MHz Crystal	£2
Speaker Grill	£1	17.734 MHz Xtal	£2
Speaker	£3	32.768MHz Xtal	£1
Keyswitch	£1.50	BBC B Refurbish	
Master PSU	£59	Casing	£25
Master Keyboard	£62	Keyboard	£46
Master Casing	£49	Power Supply	£59
Replacement Flexible 17 way Keyboard Connector			£4

## Surge Protector Plug

Fitted in place of your normal mains plug, this device protects your equipment (and data from corruption), against mains high voltage transient spikes/surges caused by lightening or thermostats switching.

Protection for only **£8.50**

## 4 Way Mains Distribution Socket

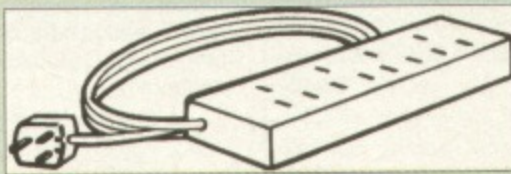

4 way top quality mains trailing sockets. Supplied wired up with mains plug ready for use. Can be screwed to floor or wall if required. Very useful for tidying up all the mains leads from your peripherals.

**£9.50**

## Aries Spike Cleaner Unit

A 4 way mains distribution unit as above with a built-in Surge Arrester, providing protection for your complete Computer/Hi-Fi System

**£14.95**

## ROM Extraction Tool

This extremely useful tool allows you trouble free chip insertion and removal from your computer by distributing the removal force over the whole body of any 24 or 28 pin chip.

**£2**

Metal Chip Extractor **£3**

## 28pin DIL Header Plug

SOLDER type **£1.50** IDC CRIMP type **£1.95**

## 8 Way DIP Switch

Increase the speed of your Disc Drives by soldering this switch to your BBC B or B+ keyboard

Only **£1.00**

28 pin ZIF SOCKET (Textool) **£6.95**

## Connecting Leads

(All ready made and tested)

CASSETTE LEADS 7 pin DIN Plug to 3 pin DIN Plug + 1 Jack Plug	<b>£2.50</b>
to 7 pin DIN Plug	<b>£3.00</b>
to 3 Jack Plugs	<b>£2.50</b>
6 pin DIN to 6 pin DIN Plug (RGB)	<b>£3.00</b>

## Disc Drive Power Leads

Supply from BBC power supply to standard Disc Drive Connection: Single **£3.00**; Dual **£3.75**

## Disc Drive Interface Leads

BBC to Disc Drives Ribbon Cable  
Single **£4** Twin **£6**

## Miscellaneous Connectors

	Plugs	Sockets
RGB (6 PIN DIN)	50p	75p
RS423 (5 pin Domino)	70p	80p
Cassette (7 pin DIN)	40p	95p
ECONET (5 pin DIN)	35p	50p
Paddles (15 pin 'D')	150p	250p
Disc Drive Plug 4 way	100p	-
6 way Power Connector	120p	150p

## Watford DATA DUCK

Convert two single Disc Drives into one Dual Drive with this simple external unit (Suitable for Disc Drives with PSU. For Disc Drives without PSU, you will also require Watford Power Duck, see below).

**£14**

## Watford POWER DUCK

**£8**

## CHIP SHOP

1 MB-10 DIL D-RAM	£4.50
1 MB ZIP D-RAM	£4.90
256K x 4-8 DIP	£4.75
256K x 4-8 ZIP	£4.80
DS3691	£4.50
DS88LS120	£5.25
LM324	£0.45
SN76489	£5.50
SAA5050	£8.75
UPD7002	£6.00
2764-250nS	£3.00
27128A-250nS (12V5)	£2.50
27128-250nS (21V)	£4.00
27256-2	£3.00
27512-2	£4.50
27C101G (1 Meg)	£7.00
4013	75p
4020	£1.00
4164-10	£1.55
4464-10	£3.50
4816 RAM	£2.00
41256-8	£2.00
41256-10	£1.50
6264LP-8K	£4.00
6502A CPU	£5.00
65C02 3M	£9.75
65C12	£9.00
6512A	£10.00
6522	£4.00
6522A	£5.00
62256ALS-15	£10.00
62256P-12	£8.50
6818	£4.00
6845SP	£6.00
68B50	£2.95
68B54	£7.50
7438	50p
74LS00	50p
74LS04	50p
74LS10	50p
74LS123	£1.00
74LS163	£1.00
74LS244	£1.00
74LS245	£1.00
74ALS245	£2.75
74LS373	£1.00
74LS393	£1.00
75453	£1.00
75159	£3.00
9637	£2.00
ICL7673PA	£3.00

## Assorted ROMS



ACORN ADFS	£25
ACORN BASIC 2 plus User Guide	£22
Acorn BCPL	£42
ACORN DNFS	£17
Acorn FORTH	£32
Acorn Graphics	£25
Acornsoft C Disc	£36
Acorn LISP	£19
Acorn OS B+	£25
Acorn OS 1.2	£14
Basic Editor	£24
BBC PCB Designer	£49
Beebmon	£22
Buffer & Backup	£20
Communicator	£49
Dump Out 3	£25
EPSON NLQ ROM	£25
Graphics Extension Rom	£10.00
GXR-B	£21
GXR-B+	£22
ICON Master	£28
Logotron LOGO	£43
MASTER OS ROM	£38
Master ULA (47)	£15
Master ULA (60)	£10
Micro Prolog	£25
Microtext Disc	£46
Microtext Rom	£199
NLQ DESIGNER	£25
Numerator - Archi	£69
Numerator - BBC	£39
Pendown ROM	£32
Rom Manager	£20
ROMIT	£29
SERIAL ULA	£13
TED	£35
Termulator B, B+	£28
Termulator Master	£32
Video ULA	£14
ULTRACALC II	£26
1Mb OS ROM	£39



## Hi-Speed, Low Cost IDE Hard Disk Drives for Archimedes

Watford's NEW Innovative IDE interface card brings the latest advances in PC hard disc technology to within reach of the Archimedes user. Over the last few years PC hard disc manufacturers have been working towards the goal of integrating the drive controller onto the hard disc, eliminating the need for an expensive controller card.

Now this has been achieved and drives are available under names such as IDE (Integrated Drive Electronics) or ATA (AT Attachment). These drives require only simple interfacing to a PC motherboard and reduce the overall cost of installing a hard disc. Because of the integration of the controller and drive electronics onto one compact board, manufacturers have been able to include extra features into the drive, such as Caching, where tracks are buffered in fast memory, reducing access times and increasing throughput. All these benefits make IDE drives far more attractive than conventional ST506 drives or SCSI. Watford's advanced interface allows IDE drives to work on any Archimedes machine, speeds in excess of SCSI devices can be obtained at a fraction of the cost of a SCSI drive.

Up to four drives are supported by the IDE filing system IDEFS, up to two drives can be attached to each expansion card, up to four cards can be installed in a machine. An optional 20Mb or 40Mb hard disc can be supplied on the podule expansion card itself, with its fast transfer rate and power saving modes the drive is ideal for storing commonly used software such as the IFonts application.

A powerful security feature has been provided with the two unique commands \*IDELock and \*IDEUnlock, ideal for educational establishments where hacking or tempering may be prevalent that may lead to loss of data. Once locked, the configuration can not be changed until a secret password is used. The IIDEForm Write Protect option is particularly useful in conjunction with \*IDELock as it will prevent any unauthorised deletion of data.

By an innovative use of on-board memory, the card will remember its configuration, even if moved to another slot or even a different machine, this also includes the unique security features.

### Hardware

- Single width EuroCard
- Supports proposed ANSI ATA (IDE) specification
- Fast 16 bit MEMC interface interrupt driven to support background disc operations
- 5 Mbytes per second peak transfer rate
- Built in Non Volatile RAM to hold configuration
- LED activity indicator
- 37 way D type socket for external drives
- Optional on-card 20Mb or 40Mb hard disc
- Up to two drives (master and slave) per card
- Multiple cards per machine (up to four)

### Software

- Conforms fully to the Acorn IDE Specification
- All software supplied in ROM
- Filing system 'IDEFS'
- Desktop filer with drive ready detection and disc name under icon

cont./-

- IIDEForm, WIMP based configuration and formatting software
- Drives can be individually write protected
- Up to four drives over multiple cards
- Power saving standby modes supported with configurable timeout
- Drives can be used without translation in native mode for minimum overhead
- IIDEFSDisk, creates PC emulator hard discs

### \*Commands

- \*IDELock
- \*IDEUnlock
- \*IDEFS  
Selects the IDE filing system 'IDEFS'.
- \*IDEDrives  
Displays the configuration and native characteristics of installed drives.
- \*Configure IDEFSDirCache
- \*Configure IDEFSBuffers
- \*Configure IDEFSDrive

### Typical transfer speeds

Prairie Tek	20Mb	650K bytes per second
Seagate	43Mb	800K bytes per second

### Prices

Part No.	Capacity	Access Speed	Price
ADA 0520	44Mb	28mS	£249
ADA 0530	89Mb	19mS	£395
ADA 0540	130Mb	19mS	£599
ADA 0550	142Mb	15mS	£699
ADA 0570	200Mb	15mS	£790
ADA 0580	330Mb	15mS	£TBA
ADA 0590	670Mb	15mS	£TBA

All the above drives are supplied complete with Controller Card, cable & Software on ROM. (Internal fitting)

Ideal for use with A300/A400/A500 Series machines.

For A3000 users an additional external Case and PSU will be required.

AAA 0300 External Case & PSU for Above £85

### Internal Hard Disc Drives for A3000

ADA 0700	21Mb	23mS	★£315
ADA 0720	44Mb	28mS	Available Soon £TBA
ADA 0730	89Mb	18mS	£TBA

Supplied complete with Podule, Fan, Cable & Fitting instructions.

★ Tentative Launch Price

### Hard Cards

#### Hard Disc on Cards for Archimedes

2.5" Hi-Speed Hard Disc Drive on a controller card.

"Simply plug and play"

For Archimedes A300 and 400 series machines

ADA 0650	21Mb	23mS	£345
ADA 0660	44Mb	28mS	£495
ADA 0670	89Mb	18mS	£TBA

(Can be used as a Removable Hard Drive)

## NEW Archimedes Cordless Mouse

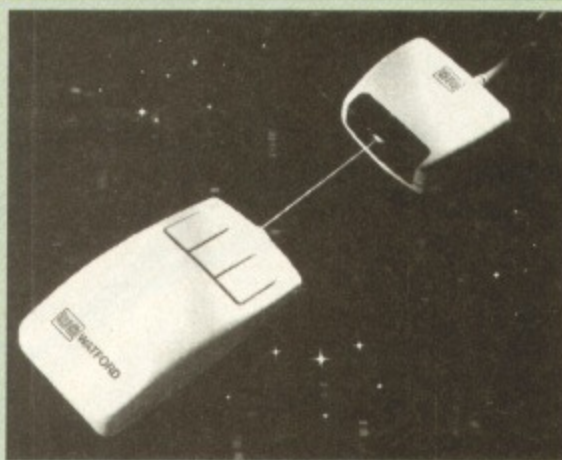

Ever found that using a mouse on a busy desktop has its problems? The cable is always being caught up in papers, tangled round equipment and other cables etc, and what about that cup of coffee spilled over your work!

Watford Electronics' new Cordless Mouse solves these problems by removing the cause for concern - replacing the cable with a simple infra red link. It still provides all the speed and easy control of a conventional mouse, but with complete freedom. In use, there are no operating differences between the standard mouse and the new cordless mouse so all mouse functions and mouse driven RISC software will be fully compatible. Pinpoint accuracy is ensured by a unique Accelerator button, which, when pressed, moves the pointer by just a tiny amount for a large slow movement of the mouse, but by a large amount for a quick wizz of the mouse.

#### Features

- Infra Red Signal Transmission
- High Resolution 200 DPI
- High Tracking Speed of 600mm/s up
- Anti-static Silicon Rubber Coated Ball
- Low Friction Teflon Footpads
- Power - by two AAA size batteries (not included)
- Automatic Standby Mode after 5 seconds inactive
- Auto Power Shut-Down after 20 seconds inactive

Price £79

# Watford Electronics

250 Lower High Street, Watford WD1 2AN, England  
Tel: 0923 37774/240588 Fax: (0923) 33642 Telex: 8956095

Prices subject to change without notice and available on request. ALL OFFERS subject to availability. Mail Order and RETAIL SHOP. Trade and Export inquiries welcome. Government and Educational Establishments' OFFICIAL ORDERS Accepted. Shop Hours: 9.00am to 6.00pm, Monday to Saturday. Thursdays 9am to 8pm. (Free Customer's Car Park). VAT: UK customers please add 17.5% VAT to cost incl. Carriage. CARRIAGE: Unless stated otherwise, minimum £2 on all orders. £3 on Larger items. On bulkier items, £7 Securicor charge applies (UK mainland only). Overseas orders, carriage is charged at cost. Specifications of all products are given in good faith but are subject to change without notice. Some items vary in their availability. Watford Electronics Terms and Conditions are available upon request. Please ring for latest delivery situation.



# AW POWER

*Rob Walmsley presents another great game for the Acorn machines*

**T**HE aliens are on the march and it's up to you to stop them. You must fly into the caves, through the defense screens and knock out their pulsating power pods. Sounds easy? Well not really, because those caves get more and more complex and gravity is a force to be reckoned with. So, good luck. You're going to need it.

The ship controls are:

- A Rotate anti-clockwise
- S Rotate clockwise
- Shift Fire thrusters
- Return Fire missile

The two listings shown here are for the 8 bit BBC Micros and Electron. You can run the program on the Archimedes by changing line 110 in Listing I to just:

```
110 NEXT
```

You'll have to set up the appropriate current directory so that Listing I chains Listing II properly. A better solution is contained on this month's subscription disc for the Archimedes.

Type in each listing in turn and make sure you've made no typing errors using the checksums. Save them as Thrust1 and Thrust2, to start just CHAIN"Thrust1".

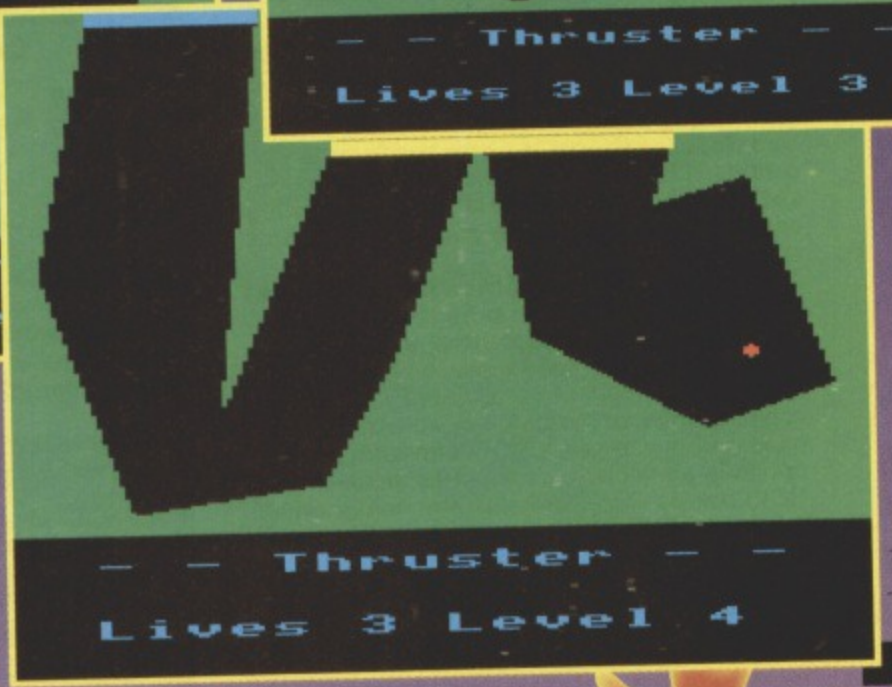
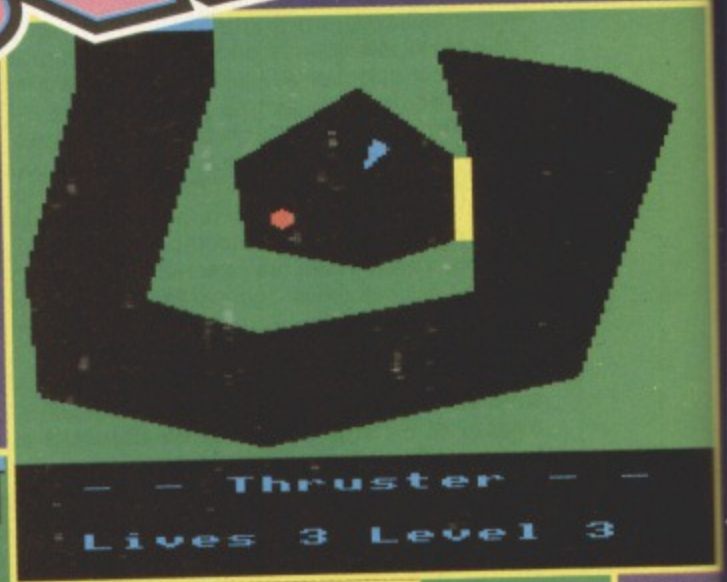

```

10 REM Thruster Part 1
20 REM by Rob Walmsley
30 REM (c) The Micro User
40 MODE2
50 VDU23;8202;0;0;0;
60 XX=36:YY=992:RX=28
70 FORIX=0TO11
80 CLS:PROCDraw(IX*30)
90 PROCConvert(0,0,224+IX*2)
100 PROCConvert(0,1,225+IX*2)
110 NEXT:PAGE=81100
120 CHAIN"Thrust2"
130 :
140 DEFPROCDraw(AX)
150 LOCAL A,B,C:A=RADA%
160 B=RAD(AX+145):C=RAD(AX+215)
170 VDU29,XX;YY;
180 MOVESINA*R%,COSA*R%
190 MOVESINB*R%,COSB*R%
200 PLOT85,SINC*R%,COSC*R%
210 ENDPROC
220 :
230 DEFPROCConvert(XX,YY,C%)
240 VDU26:XX=XX*64
250 YY=1024-YY*32
260 VDU23,C%
270 FORJX=0TO7:NX=0

```

```

280 QX=1:ZX=YY-JX*4-1
290 FOR KX=0 TO 7
300 IFPOINT(XX+(7-KX)*8,ZX)
NX=NXORQX
310 QX=QX+QX:NEXT:VDU NX
320 NEXT:ENDPROC

```

```

10 = 0 0
20 = 0 0
30 = 0 0
40 = DA59 9
50 = F716 9
60 = D5BE 6
70 = 7E90 5
80 = B94A 9
90 = 99C5 4
100 = F9ED 0
110 = B09A 1
120 = D1DC A
130 = 9719 9
140 = F110 E
150 = 44B9 F
160 = 4852 B
170 = 3208 9
180 = 47DD 6
190 = 6DCE 0

```

*Get it right ✓*

```

200 = 651A 1
210 = EDOF E
220 = 9719 9
230 = 2C8A C
240 = 373F 1
250 = 9BA8 7
260 = 6E9C 7
270 = 6598 4
280 = 1C67 E
290 = C35D 9
300 = D1CD 9
310 = D448 6
320 = E531 B

```





```

10 REM Thruster Part 2
20 REM by Rob Walmsley
30 REM (c) The Micro User
40 ON ERROR MODE7:REPORT:PRINT" at ";
ERL:END
50 MODE2:VDU23;8202;0;0;0;
60 PROCInit
70 REPEAT
80 PROCResetGame
90 REPEAT
100 PROCResetScreen
110 PROCInfo
120 PROCScreen
130 PROCStatus
140 PROCEntrance
150 REPEAT
160 IFTWIX PROCTwiz
170 PROCWalls:PROCMain
180 UNTIL Dead% ORYX>1080
190 IFDead% GCOL3,C1X:PROCDrawShip(A%,
X%,Y%):PROCExplosion(X%,Y%):Lives%=Lives
%-1 ELSEScreen%=Screen%+1:SOUND2,3,180,1
200 PROCDelay(150)
210 UNTILLives%=0
220 PROCGameOver
230 UNTILO
240 :
250 DEFPROCMain:IFTIME<mt%ENDPROC
260 OAX=A%:OXX=X%:OYX=Y%
270 VDU19,C1%,6;0;19,C2%,0;0;
280 IFEN% GOTO340
290 IFINKEY-74 IF Fire%=0 SOUND3,2,2,2
:Fire%=TRUE:FXD=S(A%)*28:FYD=C(A%)*28:FX
%=X%+36+FXD:FYX=Y%-32+FYD:FMX=6:GCOL3,7:
PLOT69,FX%,FY%
300 IFINKEY-66 AX=AX-1:IFAX=-1 AX=11
310 IFINKEY-82 AX=AX+1:IFAX=12 AX=0
320 IFINKEY-1 PROCT1 ELSE PROCT2
330 IFFire% PROCFire
340 IFTX=2 VDU19,12,TH%;0;
350 XD=XD+THX*S(A%)
360 YD=YD+THX*C(A%)
370 XD=XD*.97
380 IFXD>-.3 IF XD<.3 XD=0
390 IFTX=1 YD=YD+GR ELSEYD=YD-GR
400 X%=X%+XD
410 Y%=Y%+YD
420 GCOL3,C2%
430 PROCDrawShip(A%,X%,Y%)
440 VDU19,C1%,0;0;19,C2%,6;0;
450 GCOL3,C1%
460 PROCDrawShip(OAX,OXX,OYX)
470 IFC1%=1 C1%=2:C2%=1 ELSE C1%=1:C2%
=2
480 PROCCheckDead
490 mt%=TIME+mi%:ENDPROC
500 :
510 DEFPROCT1:THX=2
520 IFFX=1 SOUND0,-1,6,-1:F%0
530 ENDPROC
540 :
550 DEFPROCT2:THX=0
560 IFFX=0 F%=1:*FX21,4
570 ENDPROC
580 :
590 DEFPROCCheckDead:U%=X%+36:V%=Y%-32
600 P1%=POINT(U%+S(A%)*28,V%+C(A%)*28)
610 P2%=POINT(U%+S((AX+5)MOD12)*28,V%+
C((AX+5)MOD12)*28)
620 P3%=POINT(U%+S((AX+7)MOD12)*28,V%+
C((AX+7)MOD12)*28)
630 IF(P1%>3 ANDP1%<12 ORP2%>3 ANDP2%<
12 ORP3%>3 ANDP3%<12) ANDD%=-4 ENDPROC
640 IFP1%>3 ORP2%>3 ORP3%>3 Dead%=TRUE
650 ENDPROC
660 :
670 DEFPROCDrawShip(I%,X%,Y%)

```

```

680 MOVEX%,Y%:VDU 224+I%*2
690 MOVEX%,Y%-32:VDU 225+I%*2
700 ENDPROC
710 :
720 DEFPROCFire
730 GCOL3,7:PLOT69,FX%,FY%
740 FMX=FMX-1
750 FXX=FXX+FXD
760 FYX=FYX+FYD
770 Col%=POINT(FXX,FYX)
780 IFCol%>12 PROCHitBlob
790 IFCol%>3 IF Col%<12 IF D%=-4 GOTO8
10
800 IFCol%<>0 ORFMX=0 Fire%=FALSE:ENDP
ROC
810 GCOL3,7:PLOT69,FX%,FY%
820 ENDPROC
830 :
840 DEFPROCInit:F%=0
850 TWX=0:THX=-1
860 Fire%=FALSE:Dead%=FALSE
870 XD=0:YD=0:GR=1:THX=0
880 DIM S(11),C(11),EdX(7,1),GTS(2)
890 GTS(0)=" "
900 GTS(1)="Inverse Gravity"
910 GTS(2)="Invisible Landscape"
920 FORI%=0TO11:J%=I%*30
930 S(I%)=SINRADJ%
940 C(I%)=COSRADJ%
950 NEXT:
960 ti%=10:wi%=300
970 mi%=10:ENDPROC
980 :
990 DEFPROCEntrance:LOCAL GTX
1000 EN%=TRUE:X%=224:Y%=1088
1010 VDU4:COLOUR134
1020 PRINTTAB(2,0)SPC4
1030 COLOUR128:VDU5:EN%=FALSE
1040 tt%=TIME+30:wt%=TIME+30
1050 FORi%=0TO15:mt%=TIME-1
1060 PROCMain:NEXT
1070 ENDPROC
1080 :
1090 DEFPROCCircle(X%,Y%,R%)
1100 VDU29,X%,Y%;
1110 FORK%=0TORX%STEP4
1120 Q%=SQR(R%*R%-K%*K%)
1130 MOVE-Q%,K%:DRAWQ%,K%
1140 MOVE-Q%,-K%:DRAWQ%,-K%
1150 NEXT:VDU26:ENDPROC
1160 :
1170 DEFPROCBase
1180 FORJ%=0TO2:GCOL0,15-J%
1190 PROCCircle(BX%,BY%,24-J%*8)
1200 NEXT:ENDPROC
1210 :
1220 DEFPROCScreen
1230 FORI%=0TO15:VDU19,I%,0;0;:NEXT
1240 GX%=64:GY%=32:GCOL0,12
1250 RESTORE (2470+((Screen%-1)MOD10)*3
0)
1260 READ NX%
1270 FORI%=1TONX%:READ AS
1280 X1%=FNC(AS,1)*GX%
1290 Y1%=1024-FNC(AS,2)*GY%
1300 X2%=FNC(AS,3)*GX%
1310 Y2%=1024-FNC(AS,4)*GY%
1320 X3%=FNC(AS,5)*GX%
1330 Y3%=1024-FNC(AS,6)*GY%
1340 MOVEX1%,Y1%:MOVEX2%,Y2%
1350 PLOT85,X3%,Y3%:NEXT
1360 PROCDrawWalls
1370 READ BX%,BY%:PROCBase
1380 VDU4:COLOUR3
1390 PRINTTAB(2,26);"- - Thruster - -"
1400 PRINTTAB(10,29);"Level "
1410 PRINTTAB(2,29);"Lives "

```

```

1420 VDU5
1430 FORI%=3TO11:VDU19,I%,6;0;:NEXT
1440 VDU19,4,3;0;19,8,3;0;19,12,2;0;
1450 ENDPROC
1460 :
1470 DEFFnc(AS,NX%)=ASCMI$(AS,NX%)-65
1480 :
1490 DEFPROCDrawWalls
1500 READ NX%:IFNX%=0 ENDPROC
1510 FORi%=1TONX%
1520 READ WX%,WY%,WTX%,WLX%
1530 IFWTX% GOTO1600
1540 FORJ%=0TO1
1550 GCOL0,4+J%*4
1560 MOVEWX%+J%*8,WY%:DRAWWX%+J%*8,WY%+
WLX%
1570 MOVEWX%+24-J%*8,WY%:DRAWWX%+24-J%*
8,WY%+WLX%
1580 NEXT
1590 GOTO1600
1600 FORJ%=0TO1:GCOL0,4+J%*4
1610 MOVEWX%,WY%+J%*8:DRAWWX%+WLX%,WY%+J
%*8
1620 MOVEWX%,WY%+J%*8+4:DRAWWX%+WLX%,WY%
+J%*8+4
1630 MOVEWX%,WY%+20-J%*8:DRAWWX%+WLX%,WY
%+20-J%*8
1640 MOVEWX%,WY%+16-J%*8:DRAWWX%+WLX%,WY
%+16-J%*8
1650 NEXT
1660 NEXT:ENDPROC
1670 :
1680 DEFPROCWalls:IFTIME<wt%ENDPROC
1690 IFD%=4 VDU19,C%,0;0; ELSEVDU19,C%,
3;0;
1700 IFCX%+DX%=0 OR CX%+DX%=12 DX%=-DX%:wt%=T
IME+wi% ELSECX%=CX%+DX%
1710 ENDPROC
1720 :
1730 DEFPROCTwiz:IFTIME<tt%ENDPROC
1740 QX%=QX%+1:IFQX%<1 ENDPROC
1750 IFTD%=1 VDU19,TWX%,1;0; ELSEVDU19,T
WX%,0;0;
1760 IFTDX%+TWX%=12 ORTDX%+TWX%=16 TD%=-TD%
ELSETWX%=TWX%+TDX%
1770 QX%=0:tt%=TIME+ti%:ENDPROC
1780 :
1790 DEFPROCExplosion(EX%,EY%)
1800 LOCAL IX%,J%:*FX21,4
1810 SOUND1,1,150,45:SOUND0,-15,7,35
1820 GCOL3,7:VDU19,7,7;0;
1830 FORI%=0TO2
1840 EDX(I%,0)=RND(3)-2
1850 EDX(I%,1)=RND(3)-2
1860 NEXT
1870 FORI%=16 TO60 STEP4
1880 IFI%=60 GOTO1920
1890 FORJ%=0TO2
1900 MOVE EX%+EDX(J%,0)*IX%,EY%+EDX(J%,1
)*I%
1910 VDUASC".":NEXT
1920 IFI%=16 GOTO1960
1930 FORJ%=0TO2
1940 MOVE EX%+EDX(J%,0)*(IX%-4),EY%+EDX(
J%,1)*(IX%-4)
1950 VDUASC".":NEXT
1960 NEXT
1970 VDU19,7,6;0;

```

```

1980 ENDPROC
1990 :
2000 DEFPROCHitBlob:TWIX=0
2010 VDU19,13,0;0;19,14,0;0;15,0;0;
2020 GCOL0,0
2030 PROCCircle(BX%,BY%,24)
2040 PROCExplosion(BX%,BY%)
2050 VDU4:COLOUR128
2060 PRINTTAB(2,0)SPC4
2070 VDU5:ENDPROC
2080 :
2090 DEFPROCResetGame
2100 Screen%=1:Lives%=3
2110 GR=.7:GTX=0:ENDPROC
2120 :
2130 DEFPROCResetScreen
2140 TWIX=TRUE
2150 CX%=8:DX%=-4:TX=0
2160 TDX%=1:TWX%=13
2170 AX%=0:C1%=1:C2%=2
2180 XD=0:YD=0:THX=0
2190 Dead%=FALSE
2200 ENDPROC
2210 :
2220 DEFPROCInfo:VDU4:CLS
2230 COLOUR7:VDU19,7,7;0;19,8,8;0;
2240 PRINTTAB(1,10);"Entering level - "
;Screen%
2250 GTX=Screen%DIV10
2260 IF(Screen%MOD10)=0 COLOUR8:PRINTTA
B(1,12);GTS(GTX) :GOTO2280
2270 IF(Screen%MOD5)=0 COLOUR8:PRINTTAB
(1,12);"Increased Gravity":GR=.8
2280 IFTX=1 AX%=6
2290 PROCDelay(300)
2300 CLS:VDU5:ENDPROC
2310 :
2320 DEFPROCDelay(TX)TX=TIME+TX
2330 REPEATUNTILTIME>TX:ENDPROC
2340 :
2350 DEFPROCGameOver:VDU4
2360 COLOUR7:VDU19,7,7;0;
2370 PRINTTAB(0,29)"Hit spacebar to pla
y"
2380 REPEATUNTILGET=32:CLS
2390 VDU5:ENDPROC
2400 :
2410 DEFPROCStatus
2420 VDU4:COLOUR3
2430 PRINTTAB(8,29);Lives%
2440 PRINTTAB(16,29);Screen%
2450 VDU5:ENDPROC
2460 :
2470 DATA 10,AACAAQ,AKDZAZ,BRDZIZ,ISHZU
Z,PXUJUZ,MKUJUV,SKUAUJ,UDUAPA,MDSAGA,INJ
BGA
2480 DATA 2,508,448,0,172,540,688,1,232
2490 DATA 1084,900
2500 DATA 12,AACAAZ,AGCACG,OKCGPH,OKBLB
F,AZCZBK,AZLZHV,IPLZHV,IPLZUQ,UZLZUM,UQR
QUA,UFMAUA,RDGA

```

**SUBSCRIBE NOW!**  
If you prefer to save the wear and tear on your fingers you'll find this listing - together with all the others from this issue - on this month's disc, sent free if you subscribe to *The Micro User*.

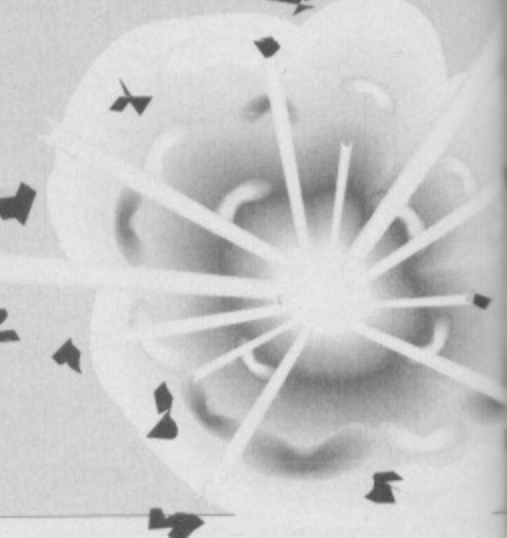



2510 DATA 1,504,540,0,148  
 2520 DATA 172,320  
 2530 DATA 14,CECAAA,CEAAAS,BZAEAZ,BZIZA  
 V,UZGZQV,UZUAQV,TGUANA,REGANA,OCGAGE,ERG  
 EHS,GNNQHS,IQNQNN,GDGMJC,JDNJMC  
 2540 DATA 1,808,604,0,144  
 2550 DATA 500,650  
 2560 DATA 13,AUCAA, AZDZAJ, AZUZH, GAJAF  
 T, JRNZHY, JRNZLH, JAPAHF, JAPAUH, UAPAUH, QEP  
 KUH, UXRIUH, UZUSLY, UZLPLY  
 2570 DATA 1,488,788,1,500  
 2580 DATA 1100,480  
 2590 DATA 14,AZCAA, AZCZAB, AZFZAV, AZUZO  
 X, RZUZUU, SAUZUU, SAUAUU, UGUANA, UDGANA, MBG  
 AGD, FHLIEU, KGPJEU, KVPJEU, KVPJSP  
 2600 DATA 1,104,388,1,144  
 2610 DATA 1100,360  
 2620 DATA 18,AZAACA, DGAZCB, DGDZAZ, DMFMD  
 Z, FZFMZ, FZFHQ, FZHZHQ, HWHZUZ, UTQYUZ, UAP  
 PUY, UAJTPP, UAJTJO, UAHJO, UAHOK, UAFKHK, U  
 AFKFG, UAGBFG, UAGBGA  
 2630 DATA 0  
 2640 DATA 1100,360  
 2650 DATA 8, AACACE, GCUEUA, GAGCUA, AAAUIN  
 , KNUAUV, URUKZ, ATDZAZ, AXOZAZ  
 2660 DATA 1,508,600,1,140  
 2670 DATA 124,380  
 2680 DATA 13, AACAAJ, CACJAJ, CHCJQJ, CHQHJ  
 J, UAGAGC, UAUAGC, UASAUZ, SZSAUZ, SZSOEO, AZC  
 JAJ, AZCJCZ, AZSZCV, AZSZQV  
 2690 DATA 8,396,804,0,154,596,804,0,154,  
 796,804,0,154,996,804,0,154,396,580,0,1  
 54,596,580,0,154,796,580,0,154,996,580,0,  
 154  
 2700 DATA 650,360  
 2710 DATA 14, AZAACA, CFAQCA, JJASCF, GAUAH  
 E, HEUAMG, LFPDMM, NTEUMK, NYAZAW, QXUZAZ, QXU  
 ZQM, ULUZQM, ULUATM, ULUASB, UFUAOC  
 2720 DATA 3,800,556,1,216,800,588,1,216,  
 792,620,1,224  
 2730 DATA 1100,800

10 = 0 0	410 = 18E6 D	810 = 815A F	1210 = 9719 7	1610 = B00F 7	2010 = 11AA 8
20 = 0 0	420 = CF54 8	820 = ED0F E	1220 = C0B1 4	1620 = BEAD 9	2020 = 130E 6
30 = 0 0	430 = 5AB9 5	830 = 9719 E	1230 = 6E33 3	1630 = 3BC5 B	2030 = 6B8C 4
40 = 693D D	440 = 200 2	840 = 2853 B	1240 = D11A D	1640 = 7C4E 4	2040 = 205B B
50 = D861 6	450 = 9A07 1	850 = 5D85 1	1250 = 236E 7	1650 = 2C83 A	2050 = 560C 0
60 = E9F5 9	460 = CDF2 8	860 = D306 1	1260 = D853 D	1660 = E531 B	2060 = 96D3 D
70 = BFBA 0	470 = 1E9A 4	870 = 4E9B A	1270 = 7F33 5	1670 = 9719 3	2070 = 7900 2
80 = EC9C 6	480 = 6A69 C	880 = FE6E 3	1280 = 86CF 5	1680 = 2B82 D	2080 = 9719 F
90 = BFBA 9	490 = 5D3E 6	890 = 9686 A	1290 = DD5F A	1690 = 9308 0	2090 = 5F5E F
100 = F9B2 0	500 = 9719 0	900 = F4DC 7	1300 = EEAA A	1700 = 2969 5	2100 = B5A0 7
110 = 5A91 5	510 = AB63 B	910 = 307C 8	1310 = E6B 2	1710 = ED0F C	2110 = 74F0 4
120 = A030 0	520 = DCC 8	920 = 7BC C	1320 = CDB7 1	1720 = 9719 8	2120 = 9719 0
130 = F779 A	530 = ED0F 2	930 = 7A7D 6	1330 = B098 5	1730 = 94D4 9	2130 = 4BE2 8
140 = 3ABC 3	540 = 9719 3	940 = 7BFF 5	1340 = 866B C	1740 = 4F2 0	2140 = B135 0
150 = BFBA 4	550 = 53A3 7	950 = F1F7 1	1350 = 1D95 E	1750 = 78B3 2	2150 = 721D 4
160 = C2E5 7	560 = A9D0 F	960 = FA79 2	1360 = 2C3C C	1760 = ED24 D	2160 = 306E A
170 = ACES A	570 = ED0F 7	970 = 803E 3	1370 = 8FB9 7	1770 = 3847 5	2170 = 8561 5
180 = 54DF 7	580 = 9719 7	980 = 9719 C	1380 = 7382 3	1780 = 9719 5	2180 = FED6 F
190 = 715F 5	590 = D92C C	990 = 5F58 3	1390 = A016 5*	1790 = 546D B	2190 = BBEB 1
200 = 9608 0	600 = 2CD2 B	1000 = F29 3	1400 = 6E9D 4	1800 = B352 7	2200 = ED0F 3
210 = 3618 5	610 = D3EE E	1010 = A4B1 8	1410 = 1511 4	1810 = 7FC1 5	2210 = 9719 F
220 = B9BD F	620 = 3A5A 0	1020 = 96D3 4	1420 = 667A 5	1820 = 735 D	2220 = C31C C
230 = 53CE 6	630 = AABF 0	1030 = ACB8 8	1430 = 7812 E	1830 = 980F 0	2230 = 11E E
240 = 9719 B	640 = 6ECD 6	1040 = 805D 9	1440 = B261 1	1840 = 833E 9	2240 = 1C5E 4
250 = 3851 D	650 = ED0F 9	1050 = 59A4 F	1450 = ED0F 1	1850 = 681D D	2250 = 9C78 1
260 = 5030 B	660 = 9719 3	1060 = 34B7 6	1460 = 9719 B	1860 = 2C83 0	2260 = 4DB9 8
270 = F3F2 5	670 = 9145 A	1070 = ED0F 9	1470 = 6B3E 8	1870 = 78 7	2270 = A90C 0
280 = 7642 C	680 = 1EB1 A	1080 = 9719 3	1480 = 9719 E	1880 = 1904 B	2280 = 21B A
290 = 7CF3 0	690 = 377C 1	1090 = 7C23 7	1490 = 9FFE F	1890 = 56EF 7	2290 = 9090 9
300 = 3A16 6	700 = ED0F 3	1100 = 3208 A	1500 = 365E 4	1900 = 5329 A	2300 = 5456 A
310 = 1F1F F	710 = 9719 5	1110 = D7C3 A	1510 = 2C00 8	1910 = 63B7 B	2310 = 9719 4
320 = 979A 2	720 = 8FE5 7	1120 = 9B1B C	1520 = A209 A	1920 = F076 7	2320 = A59C 3
330 = 25C3 0	730 = 815A 4	1130 = 44A0 0	1530 = F043 6	1930 = 56EF 2	2330 = 5D4E C
340 = A70 7	740 = 6372 8	1140 = 9CE8 E	1540 = 668C D	1940 = 37B1 E	2340 = 9719 1
350 = 3006 0	750 = FA98 7	1150 = B447 2	1550 = 5EC3 C	1950 = 63B7 0	2350 = CE50 0
360 = 99D5 B	760 = E34C 5	1160 = 9719 0	1560 = COEF B	1960 = 2C83 E	2360 = D706 9
370 = B1C1 4	770 = C7BB 6	1170 = DF84 D	1570 = 1CFA 6	1970 = 1020 1	2370 = 5EE6 D
380 = 8EB4 3	780 = 889 F	1180 = 171E 5	1580 = 2C83 D	1980 = ED0F B	2380 = C3A4 D
390 = 9E3B A	790 = 2667 4	1190 = C535 9	1590 = 58BE 4	1990 = 9719 5	2390 = 7900 7
400 = C655 D	800 = 85D4 E	1200 = E531 C	1600 = 5593 F	2000 = 3F7A 0	2400 = 9719 7

Get it right ✓

2410 = 97F8 D  
 2420 = 7382 E  
 2430 = EAAA 3  
 2440 = 8AEB 0  
 2450 = 7900 0  
 2460 = 9719 0  
 2470 = 4E44 9  
 2480 = 4C5B C  
 2490 = A010 6  
 2500 = 9C3B 5  
 2510 = E567 9  
 2520 = 828C 9  
 2530 = 6964 F  
 2540 = 7F59 E  
 2550 = BDEF E  
 2560 = 4200 D  
 2570 = 3745 0  
 2580 = 5ACD 6  
 2590 = B7CB 5  
 2600 = 5385 4  
 2610 = FC52 8  
 2620 = C8E0 B  
 2630 = 2040 1  
 2640 = FC52 E  
 2650 = A5E4 6  
 2660 = 1FDE D  
 2670 = E3C3 F  
 2680 = 6D48 D  
 2690 = C551 8  
 2700 = 98CF D  
 2710 = 8D7A C  
 2720 = 9EF6 8  
 2730 = A605 7

# Want a dirt cheap Archimedes Computer?...

## ...don't come to us!

*However, we can offer you...*

- Expert advice on the best Archimedes hardware and software for your needs
- Fast, courteous mail order service, once you have decided what you want to buy
- After sales service from people who know what they are talking about
- A magazine which we publish, called "Archive", to keep you up-to-date
- Special discounts for Archive subscribers on both hardware and software

*Why not give us a call and talk to Paul or Adrian?*

### *...Remember, price isn't everything!*

## **Norwich Computer Services**

96a Vauxhall Street, Norwich NR2 2SD. Phone 0603-766592. Fax -764011



# Ace Computing



**RISC OS Euclid** is the best multi-tasking 3D graphics and animation system for the Archimedes. It is effectively a 3D version of Draw.

**Mogul** makes full use of **Euclid's** unique hierarchical data structure to generate animations of 3D objects with articulated motion and simultaneous camera motion.

**ArcLight** is a multi-tasking ray-tracer which will generate a realistic Euclid picture, or a complete Mogul film, while you are free to get on with other work.



**Tween** produces films from Draw files. It uses techniques similar to **Mogul** and generates a film by calculating intermediate frames from a set of key positions.

**Splice** allows you to edit films produced by **Mogul** or **Tween**. You can even produce hand-drawn cartoons by converting sprites from any source.

Such is the enthusiasm for **Euclid** there is a user group called **Elements**, now in its second year, which provides a quarterly disk containing hints, tips, animations and user pictures.

**ArcLight** £50  
**Euclid** £70  
**Mogul** £20  
**Splice** £30  
**Tween** £30  
(inc.VAT)

Ace Computing  
27 Victoria Road,  
Cambridge,  
CB4 3BW.

Tel: (0223) 322559  
Fax: (0223) 69180





# In symmetry

**INTERLOCKING** tiling patterns are fascinating – the number of ways complex shapes can be interlocked is quite staggering. The study of tiling also is an important introduction to the rules of symmetry.

The theory of tiles is quite complex, however there are only a few ways in which you can arrange them regularly and symmetrically. In fact there are only three such methods.

If you take a point you can surround it with six triangles, three hexagons or four squares. Of these, the triangular symmetry is the most versatile.

If the grid you are working on is triangular you can have basically eight different shapes. In other words there are eight different ways to draw over the grid lines: You can draw in one triangle side or leave it open, for each of the three sides.

In addition two other patterns can usefully be drawn in the grid space. While strictly speaking they are not on the triangular grid, they do add flexibility to the design.

Now if you number each of these triangles you can specify any pattern by the sequence of numbers defining what grid lines to draw. As any symmetrical pattern will repeat, you need only specify a short repeating rule. However this only covers one row of the pattern. In order to specify the repetition in the vertical direction you need a sequence of numbers to use on each line.

All this sounds more complex than it is. The listing will allow you to type in the rules and watch the resulting pattern, and the best way to understand what's happening is to see it in action.

Type in the listing and make sure that you've made no errors by using the checksums. Run the program and you will see, numbered, all the different shapes you can draw. The simplest pattern is produced by drawing on all the grid lines, in other words triangle 7.

So type 7 and press Return, then press Return again and the screen will

## Mike Cook shows how tiling patterns can produce quite complex shapes

fill with triangles. Typing S will allow you to change the scale – try it with a scale of 8. Now press the spacebar and go for a more interesting pattern. If we want a grid of hexagons we need two rules, the first is 241 and the second 412.

To make a specific pattern it's probably best to print out a grid of triangles and draw over the top the required pattern. Then you can write inside each triangle its type number to find the repeating rules. The table shows some patterns to try.

The one labelled Islamic art is not quite right. I was trying to copy it from a reference book on patterns, and it turns out that it has a lot more rules due to the fact it has an odd number of rules before a repeat.

However, it is a good starting point for some complex patterns. If you come up with a good set of patterns why not send them in to the Letters page?

```
10 REM > Tile
20 REM by Mike Cook
30 MODE 0
40 PRINT "Tiling Patterns"
50 PRINT "Using triangular six point s
ymmetry"
60 PRINT "By Mike Cook"
70 DIM T$(30)
80 NS=12
90 DX=4*NS
100 DY=SQR(.75)*DX*2
110 DSX=(INT(DY*0.7) DIV 4)*4
120 MOVE 0,800
130 VDU 5
140 FOR A=1 TO 9
150 PLOT 0,1.5*DX,-DSX
160 PRINT ;A;
170 PLOT 0,-1.5*DX,DSX
180 PROC_DTS("7")
190 PRINT SPC(2);
200 NEXT
210 MOVE 16,800-3*DY
220 FOR A=1 TO 9
230 PROC_DTS(STR$(A))
240 IF A=8 THEN PRINT SPC(4); ELSE PRI
```

```
NT SPC(3);
250 NEXT
260 TL=0
270 VDU 4
280 PRINT TAB(0,18);"Pattern tiling"
290 PRINT "Type in the Rules"
300 PRINT "Press return to end"
310 PRINT "Then :- "
320 PRINT "S to change scale"
330 PRINT "P to print out"
340 PRINT "Any other key for another pa
ttern"
350 PRINT "Now what are the rules ?"
360 REPEAT
370 INPUT T$(TL)
380 TL=TL+1
390 UNTIL T$(TL-1)=""
400 TL=TL-1
410 DX=4*NS
420 DY=SQR(.75)*DX*2
430 LF=0:Y=0:L=0
440 CLS
450 REPEAT
460 TC=0
470 BS=1
480 IF LF=0 THEN MOVE 0,Y ELSE MOVE -D
X,Y
490 LF=LF EOR 1
500 REPEAT
510 TD=VAL(MID$(T$(L),BS,1))
520 PROC_TD(TD)
530 TC=TC+1
540 BS=BS+1
550 IF BS>LEN(T$(L)) THEN BS=1
560 UNTIL TC*DX > 1280
570 Y=Y+DY
580 L=L+1
590 IF L=TL THEN L=0
600 UNTIL Y>1023
610 AS=GET$
620 PRINT TAB(0,31)
630 IF AS="P" OR AS="p" THEN PROC_DUMP
640 IF AS="S" OR AS="s" THEN INPUT "New
Scale ",NS:GOTO 410
650 CLS:GOTO 90
660 END
670 DEF PROC_DTS(C$)
680 FOR B=1 TO LEN(C$)
690 TD=VAL(MID$(C$,B,1))
700 PROC_TD(TD)
710 NEXT
720 ENDPROC
730 DEF PROC_TD(T)
740 LOCAL A
750 IF T=8 THEN PROC_CT1:ENDPROC
```

### Triangles and Hexagons

Rule 1 = 430546430546  
Rule 2 = 120012120012  
Rule 3 = 546430546430  
Rule 4 = 012120012120

### Cubes

Rule 1 = 261  
Rule 2 = 053  
Rule 3 = 040  
Rule 4 = 000

### Stars

Rule 1 = 506434  
Rule 2 = 200121  
Rule 3 = 434506  
Rule 4 = 121200

### Islamic art

Rule 1 = 50624344210200181190  
Rule 2 = 20018119450624344212  
Rule 3 = 43442122001811945062  
Rule 4 = 81194506243442122001  
Rule 5 = 21220018119450624344

### Patterns to try

### Tulips

Rule 1 = 89  
Rule 2 = 98

### Pyramids

Rule 1 = 456  
Rule 2 = 543

### Chips

Rule 1 = 0000261  
Rule 2 = 0261222  
Rule 3 = 2222220  
Rule 4 = 2220530  
Rule 5 = 5300400  
Rule 6 = 0400000

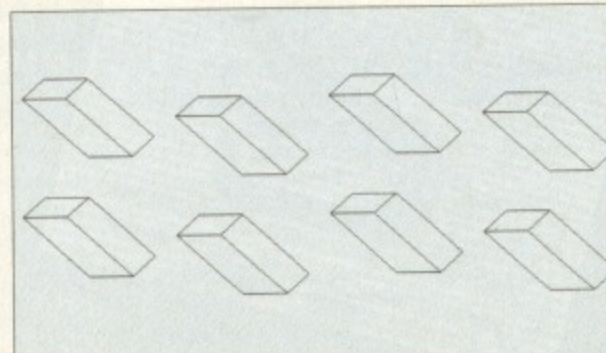
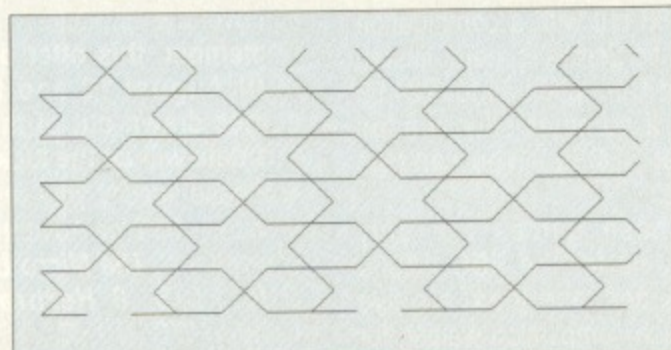
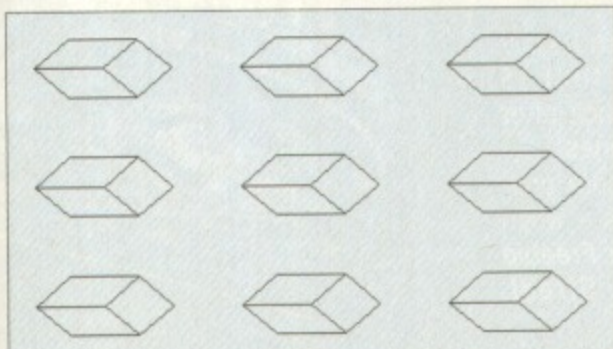



FEATURE

```

760 IF T=9 THEN PROC_CT2:ENDPROC
770 IF (T AND 1)=0 THEN A=0 ELSE A=1
780 PLOT A,DX,DY
790 IF (T AND 2)=0 THEN A=0 ELSE A=1
800 PLOT A,DX,-DY
810 IF (T AND 4)=0 THEN A=0 ELSE A=1
820 PLOT A,-2*DX,0
830 PLOT 0,2*DX,0
840 ENDPROC
850 DEF PROC_CT1
860 A=DY DIV 2
870 PLOT 1,DX,A
880 PLOT 1,0,A
890 PLOT 0,0,-A
900 PLOT 1,DX,-A
910 ENDPROC
920 DEF PROC_CT2
930 A=DY DIV 2
940 PLOT 1,0,A
950 PLOT 1,-DX,A
960 PLOT 0,DX,-A
970 PLOT 1,DX,A
980 PLOT 0,-DX,-DY
990 ENDPROC
1000 DEF PROC_DUMP
1010 PRINT"Insert your dump routine her
e"
1020 REPEAT UNTIL GET
1030 ENDPROC
1040 REM Archimedes/BBC A3000 machines
change:
1050 REM 1010 ss%=ss%+1
1060 REM 1020 OSCLI("ScreenSave Pattern
"+STR$ss%)

```

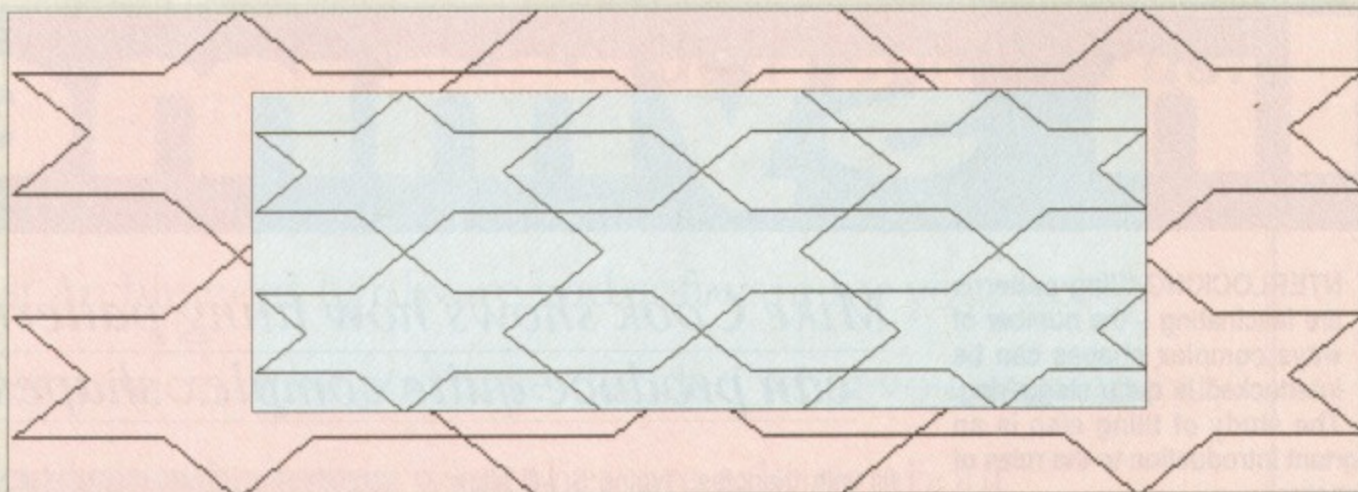

10 = 0 0	180 = 5891 7	350 = B67 9	520 = 8CE 3	690 = AEB7 A
20 = 0 0	190 = A53 B	360 = BFBA 4	530 = A56C 2	700 = 8CE 2
30 = 6075 5	200 = 2C83 6	370 = 3AFB 0	540 = 56EB 4	710 = 2C83 3
40 = AF55 8	210 = B2A6 5	380 = 4C5E C	550 = AF6B 4	720 = ED0F 2
50 = 85F9 F	220 = 72CA 8	390 = 1A1F 6	560 = 850B 0	730 = C2C B
60 = FC23 F	230 = 6399 5	400 = E6F8 7	570 = EF4D D	740 = 39F3 3
70 = AF23 E	240 = F266 E	410 = AF22 3	580 = 1B8E 3	750 = 5931 7
80 = 9766 B	250 = 2C83 7	420 = 864A A	590 = 4940 0	760 = D828 5
90 = AF22 2	260 = 929C B	430 = BD71 4	600 = 7410 6	770 = BD12 5
100 = 864A 4	270 = FC31 0	440 = 7A16 B	610 = 77F2 4	780 = A582 D
110 = 342 A	280 = EB26 C	450 = BFBA 2	620 = 5D02 4	790 = 555F 0
120 = 54D0 0	290 = 93AA 0	460 = BEAD D	630 = F9CF 8	800 = DC46 0
130 = EC10 2	300 = FB61 C	470 = D1D1 0	640 = D16E F	810 = 95E4 7
140 = 72CA D	310 = 91FD E	480 = 17AC E	650 = 667 D	820 = 9DE0 9
150 = 3F8A 9	320 = 414E 5	490 = D0AB 2	660 = F02E B	830 = 2A04 F
160 = 2ED8 0	330 = F9EA 0	500 = BFBA 7	670 = 5281 B	840 = ED0F 0
170 = 9AAB A	340 = 8FA C	510 = 39B F	680 = 9942 3	850 = E498 F
				860 = F8A8 F
				870 = 82A4 3
				880 = 1A98 3
				890 = 7879 7
				900 = 368 5
				910 = ED0F E
				920 = D4FB C
				930 = F8A8 5
				940 = 1A98 1
				950 = D1A4 1
				960 = BB09 7
				970 = 82A4 8
				980 = DC85 3
				990 = ED0F 1
				1000 = 5476 2
				1010 = 6EDD 3
				1020 = 69E5 5
				1030 = ED0F E
				1040 = 0 E
				1050 = 0 E
				1060 = 0 E

Get it  
right ✓

**F**rom now on each month we'll be featuring a special offer made exclusively to readers of *The Micro User*, highlighting one company or product and giving you the chance to lay your hands on some super free software or hardware.

This time CIS are offering samples of their games Minipacks. All you have to do is to write directly to CIS at the address below – not to *The Micro User* – and the first 15 names and addresses received after August 12 will receive a sample product:

**MiniPack 6** comprises *Fireball 2*, *Memory Magic* and *Quasar* and is a must for arcade players who enjoy the cut and thrust of fighting off aliens with the brain teasing concentration needed in *Memory Magic*.

**MiniPack 7** is another mix of games with something for everyone. Holed



# It's FREEBIES Time!

Out lets you tee off from the best golf courses in the world without leaving your computer screen, while *Star Trader* takes you on a mission to save the universe, leaving *White Magic* to transport you to a time of magic and arcade adventure.

The **Adventure Pack** is reviewed on Page 88 but with a combination of *Magnetic Scrolls'* superb *Jinxter*, *Fish* and *Corruption* all for £24.99 – with a summer silly season offer of £14.99 – you can't go wrong.

These games are only available for the BBC A3000 and Archimedes, and there are five copies of each compilation waiting for

you – worth £24.99 each though a limited offer of £14.99 each is in operation over the summer.

**Remember, this offer doesn't start until August 12 and the first 15 entries drawn out of the sack after this date will be the lucky ones.**

● Please specify your mini-pack preference – 6, 7 or Adventures – when you write to: **The Micro User Freebie Offer, CIS, 8 Herbrand Street, London WC1N 1HZ.**





# Memory Expansion

- A310** - Low power consumption  
 - Larger OS ROM option  
 - ARM3 compatible  
 - Includes MEMC1a upgrade worth over £80  
 - 2Mb - £225 4Mb - £350

Phone for educational and quantity discounts

We have been upgrading 300 series computers for nearly two years, and established a reliability record second to none. Our 2Mb and 4Mb upgrades use quality components and fully tested circuit boards. We offer a no quibble money-back guarantee and a professional back-up service.

Send for our free information sheet. Then decide.

- A3000** - Only 8 RAM chips - low power consumption  
 - User fittable - no soldering required  
 - Available as a "bare board" (ie sockets, but no RAM)  
 - 4Mb - £175 2Mb - £65 Bare board - £30

All prices include VAT.

Contact us for competitive prices on hard discs, ARM3 upgrades, backplanes, and all Acorn products.



Further information and price list from:



**IFEL**

36 Upland Drive, Derriford, Plymouth  
 PL6 6BD. (0752) 847286

# VOLTMACE

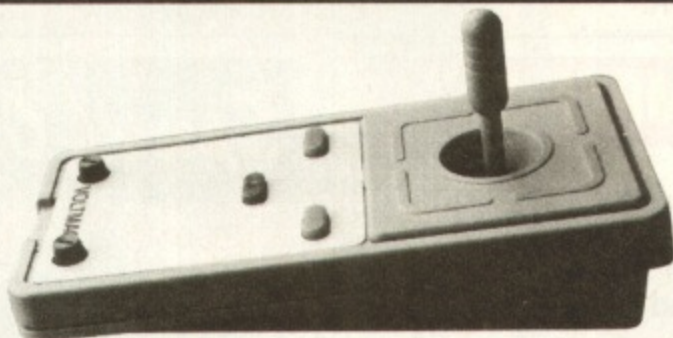

## DELTA-CAT ARCHIMEDES JOYSTICK

The lowest cost and most versatile of the joysticks for the Archimedes. Needs no interface - just plugs into the mouse port. With no software changes it will immediately run any mouse driven software. With specially written software it can be made to act as an analogue joystick or a digital joystick. All good software should have this joystick as an option where relevant.

The Delta Cat costs just £34.95 inclusive.

## MOUSE PORT SPLITTER BOX

Almost a necessity on an A3000 to save keep lifting the computer up to change from mouse to Delta-Cat. The Splitter Box has two mouse sockets on it and a switch to select which socket is in use. Can also be used for other items such as trackballs. Even on an A300/400 series it can pay for itself by saving damage to your keyboard socket or mouse plug.

The Mouse Port Splitter Box retails for £19.95 inclusive.

## DELTA 3B SINGLE AND DELTA 3B TWIN

The true analogue joystick for either the BBC B, BBC Master, or Archimedes range of computers. Accessed by Basic Advial commands. The Delta 3B series joysticks will plug straight into the Analogue Port of a BBC B or Master. To work on an A300/400 Archimedes you will need a backplane and I/O module. To work on an A3000 you will need an A3000 BBC Analogue + User Port Module.

- Delta 3B Single Joystick** £16.95  
**Delta 3B Twin (Dual) Joystick** £24.95  
**Deltabase B Yoke Style Joystick** £34.95



Unit 9, Bondor Business Centre, London Road,  
 Baldock, Herts, SG7 6NG. Telephone (0462) 894410



# WeServe of Hampshire Best for service

## Panasonic

### KXP4420 Laser

512k ram 8 pages per minute  
 2 years on Site warrantee

**£648 + VAT**

- KXP1081** £145.00  
**KXP1180** £149.23  
**KXP1123\*** £185.65  
**KXP1124i\*** £252.63

prices inc VAT, cable & paper  
 \* 24 pin printers

### Philips BM7502

Green Screen Monitor with cable  
**£69.00 + VAT**

### Philips CM8833 Mk2

Colour Monitor with cable  
**£225.00 (£195.65 + VAT)**

### Taxan 775

Multisync Monitor with cable  
**£369.00 + VAT**

### Taxan 795-A

Trinitron Multisync + VIDC  
**£419 + VAT**

## PRINTER RIBBONS

	Ex VAT	Inc VAT
LX800 & FX800 Print Ribbon	£2.29	£2.69
LC10 Print Ribbon	£4.00	£4.70
120D Print Ribbon	£4.00	£4.70
Taxan/Canon Ribbon	£3.22	£3.78
Juki 6100 Print Ribbon	£1.60	£1.88

Phone for full range 100 + original & Compatible ribbons - Bulk discounts

## UPGRADES/8271

	Ex VAT	Inc VAT
27128A 250nS 12.5v	£3.00	£3.52
8271 controller	£38.26	£44.95
6264 LP 150nS	£3.00	£3.53
Acorn 8271 DFS	£44.26	£52.00
Acorn 1770 DFS	£45.11	£53.00
A3 Concept Keyboard	£139.00	£163.32
Master Keyboard	£50.21	£59.00
Acorn Tracker Ball	£38.30	£45.00

**A410 + 4M + 40M HD**  
**£1410.00 (£1200.00 + VAT)**

**20M Hard Disc**  
**£139.83 (£119.00 + VAT)**

**A420LC + Colour**  
**£1492.25 (£1270.00 + VAT)**

**A540 + Multisync**  
**£3290.00 (£2800.00 + VAT)**

**A3000 + 2m RAM**  
**£658.00 (£560.00 + VAT)**

**A3000 LC + 2m RAM**  
**£775.50 (£660.00 + VAT)**

## Star

LC10	£149.00
LC200	£199.00
LC2410	£188.00
LC24200	£244.40
LC24200Col	£299.00

prices inc VAT, cable & paper

## Swift 24

2 year warrantee

**£245.00 inc VAT**  
 Colour kit with printer £24.00

### Citizen 120D+

with cable and paper  
**£128.00 (£108.94 + VAT)**

### Canon LPB-4

300dpi Laser with cable & paper  
**£639.00 + VAT**

### Canon BJ10e

360dpi Ink jet with cable & paper  
**£199 + VAT**

## ROMS/SOFTWARE

	Ex VAT	Inc VAT
Inter-Word Rom	35.75	42.00
Spell Master Rom	40.00	47.00
View 3 Rom	40.00	47.00
DTP-Acorn	106.38	125.00
Impressions II	134.47	158.00

Phone for BBC/Archimedes Software catalogue 100's of titles inc. Educate

**A3000 1M Upgrade**  
**£57.58 (£49.00 + VAT)**

**A3000 TV Modulator**  
**£39.90 (£33.96 + VAT)**

## DISKETTES

SONY branded

(100% certified error free)

	Inc. VAT
10 3.5" DS/DD 135 tpi	£27.50
50 3.5" DS/DD 135 tpi	£32.31
100 3.5" DS/DD 135 tpi	£59.93
1k 3.5" DS/DD 135 tpi	£540.50

**DISKETTES**  
 (lifetime warranty) SONY bulk  
 (100% certified error free)

	Inc. VAT
10 3.5" DS/DD 135 tpi	£5.95
50 3.5" DS/DD 135 tpi	£19.80
100 3.5" DS/DD 135 tpi	£37.95
250 3.5" DS/DD 135 tpi	£82.25
1k 3.5" DS/DD 135 tpi	£309.03
50 x 3.5" Disk Box with lock	£5.99
100 x 3.5" Disk Box with lock	£7.50

	Exc VAT
10 3.5" DS/DD 135tpi	£7.00
10 3.5" DS/HD	£13.50
10 5.25" DS/DD 48tpi	£5.00
10 5.25" DS/HD	£9.00

Phone for our 40 page catalogue

EDUCATIONAL AND GOVERNMENT ORDERS WELCOME

All products have a 30 day money back & 12 month warranty.

Prices subject to variation without prior notification.

Established 6 years. We are closed Saturday afternoons.

Free parking. 2 minutes from M27 Junction 11.

Postage 94p (80p + VAT) Securicor £7.05 (£6.00 + VAT).

**WeServe**



Larger items delivered  
 by Securicor



Micro Dept  
 40-42 West Street,  
 Portchester, Hants.  
 PO16 9UW  
 Tel: 0705 325354

# FUN SCHOOL!

TAPE 5.25" DISC  
£9.95 £12.95  
3.5" Master £24.95

### Ages 2-5

- Alphabet
- Colours
- Counting
- House
- Magic Garden
- Matchmaker
- Numbers
- Pelican
- Seaside
- Snap

### Ages 5-8

- Balance
- Castle
- Derrick
- Fred's Words
- Hilo
- Maths Test
- Mouser
- Number Signs
- Seawall
- Super Spell

### Ages 8-12

- Anagram
- Codebreaker
- Dog Duck Corn
- Guessing
- Hangman
- Maths Hike
- Nim
- Odd Man Out
- Pelmanism
- Towers of Hanoi

## Educational Bundle

- Use your BBC Micro to teach and amuse your children at the same time.
- Three packages crammed full of educational programs – and so easy to use!
- Each program has been educationally approved after extensive testing in the classroom

## NURSERY RHYMES 5

fun-packed educational programs... for young children everywhere

This delightful collection of programs is based around children's favourite Nursery Rhymes. There's plenty of sparkling colour, sound and captivating animation to keep them riveted – and as they play they'll be learning all the way.

- ★ Tell the time with Hickory Dickory Dock.
- ★ Assemble the jigsaw in Humpty Dumpty.
- ★ Learn to spell with Jack and Jill.
- ★ Match the animals in See Saw Marjory Daw.
- ★ Play an exciting game in Hey Diddle Diddle.

It's Amazing  
It's Radical  
It's the Rolling Ruler



A complete drawing board in one simple unit. With a rolling ruler you can draw:

- ★ Horizontal parallel lines
- ★ Vertical parallel lines
- ★ Perfect right angles with ease
- ★ Any other angles from 1° to 359°
- ★ Clever circles

Available in two sizes 22cm (8in) and 30cm (12in) this great offer gets you both rolling rulers for just £6.50 (RRP £9.99)

It's innovative design gives the new rolling ruler the ability to draw vertical and horizontal lines without lifting it off the paper, parallel lines, angles, circles, musical staves and graphs with ease, making it ideal for the home, the office, schools, workshops and 3D design work.

## THE PERFECT PAIR

The best-selling, award-winning BBC software is now joined by THE definitive guide



### The Program

Mini Office II is the highly-acclaimed suite of integrated programs which turn your computer into a versatile business machine.

It's the perfect package to increase your personal productivity – with more than 400,000 satisfied users across the complete Mini Office range.

### The Book

The Dabhand Guide to Mini Office II is a brand new book to help you get the most out of the software. It not only contains the facts, but also the kinds of hints and tips that can only be built up through years of computer use.

More than a manual, the guide assumes nothing. Beginning with the first sentences typed into the editor, you are led through all aspects of using the system, up to the most advanced techniques.

All the examples are also on an accompanying disc which even includes a very useful routine to print out large spreadsheets sideways.

## CLASSIC GAMES COMPENDIUM

We've brought together some of the most popular compilations ever to have appeared in *The Micro User* for this special offer. For a limited period, we are offering them on four 5.25" discs for the give-away price of £14.95!

### WHAT YOU GET:

- ★ 9 Classic Card and Board Games Volume 1
- ★ 9 Classic Card and Board Games Volume 2
- ★ Ten of the Best Games
- ★ Classic Arcade Games



## Special Offer

SAVE £40



Acornsoft  
Forth Rom

~~£49.95~~

£9.95

Reduced to clear while stocks last



**Product:** ArcComm 2  
**Price:** £63.45  
**Supplier:** Longman Logotron, Dales Brewery, Gwydir Street, Cambridge CB1 2LJ.  
**Tel:** 0223 323656  
**Requirements:** BBC A3000 and Archimedes range

**T**HE ability to talk via computer link to anyone anywhere in the world is an ideal that only seems to exist in theory. In practice people sometimes don't access their mailboxes for weeks on end, modems play up and software systems change.

Computer world jargon proliferates when given the additional gadgetry needed for Email. All in all, electronic communications is a world strewn with the corpses of the uninitiated.

Both Longman Logotron and The Serial Port have released software aimed to make our lives easier, but will either be the definitive answer to communications? Let's see.

ArcComm 2 is aimed fairly and squarely at schools. Fully multi-tasking, according to Longman Logotron it has been designed to "offer easy access to the first-time user, while still

preserving sophistication for the seasoned communicator".

With the built-in access to France's Teletel and Germany's BTX systems, as well as the more usual Prestel, the initial planning seems to have been well thought out.

The ArcComm 2 manual plunges in at the deep end with a MakeCampus utility allowing first time users to create a procedure containing their own Campus 2000 ID and phone number.

This tutorial is simple to follow and for many schools it will be as technical as they need. The fact that the Curriculum Guide precedes the Technical Manual underlines this point. However, true to their promise Logotron have made additions for the more adventurous.

The Curriculum Guide is essentially practical, using instances and examples of how to print and save text for a project from Campus 2000. Making good use of illustrations, it should reassure even the most fearful Email user.

These chapters show how to download information and share it with other schools, acquire information from the more formalised Prestel and specific Neris systems as well as how to acquire telesoftware.

From a more technical point of view, ArcComm 2 differs from the origi-

nal BBC Micro program with its procedure language allowing a greater say over the running and presentation of the software and the results.

A system can be configured to grab and save mail automatically when Telecom Gold is accessed for instance, while its multi-tasking attributes lead to easy integration of information from one system to another. As to be expected from a full

Risc OS program, you can always access the icon bar, and it is nice to see the inclusion of modes which allow a full 80 x 24 text screen.

The user interface is friendly and the standard use of protocols such as X and Y-modem is what you'd expect. However, I wasn't too keen on the two icons - one for software and one for hardware. A reasonable idea but unnecessary.

# Speak to me

*Is Email a dream come true or a nightmare? Pam Turnbull seeks the answer in two new packages*

**Product:** ArcTerm VII release 1.26  
**Price:** £79.95 inc VAT  
**Supplier:** The Serial Port, Burcott Manor, Wells, Somerset BA5 1NH.  
**Tel:** 0243 531194  
**Requirements:** BBC A3000 and Archimedes range

ArcTerm is a meatier package, not so specifically geared towards the education market but extremely powerful. As with ArcComm, I used my oldish 1200/1200 modem and it seemed equally happy with both pieces of software, though ArcTerm was improved when working on my 310 with a hard drive rather than on a 1Mb A3000.

When loaded, ArcTerm pops a stylish 7 on the icon bar, checks the modem and loads in the phone lists.

Opening the applications gives access to an array of options concerning file transfer, configuration, terminal emulation plus a host of other options.

The menus are self-explanatory with the dialling procedure a matter of highlighting diamonds.

However simple this is for the experienced user and its intuitive nature, I would have to recommend a through reading of the manual before committing yourself to the mercies of British Telecom and the indications of tone or

pulse dialling. There is a redial facility and the ability to deal with baud rates from 50 to 19200. Saving the screens as a sprite file is standard and easy to use.

Moving on to file transfer, the formats supported are very impressive as are the terminal emulations. I was glad to see a straightforward way of presetting procedures for calling favourite bulletin boards and the like.

The manual is extensive and well written. You'll find some useful information in the appendices whether you want to buy a modem, understand the Ascii control codes or get to grips with smileys, CyberPunk or a well researched glossary.

It is very difficult to compare these two packages, which are horses for very different courses. If you just want to access bulletin boards for information transfer then ArcComm is for you. The manual is especially easy to follow.

However, if you can see yourself wanting more, perhaps to set up a bulletin board or access a wide range of facilities with different compatibilities and formats, I would plump for Serial Ports ArcTerm.

The menus and sub-menus on the ArcTerm program are a lot easier to follow, as well as giving a much wider choice than the simpler ArcComm 2 ones.

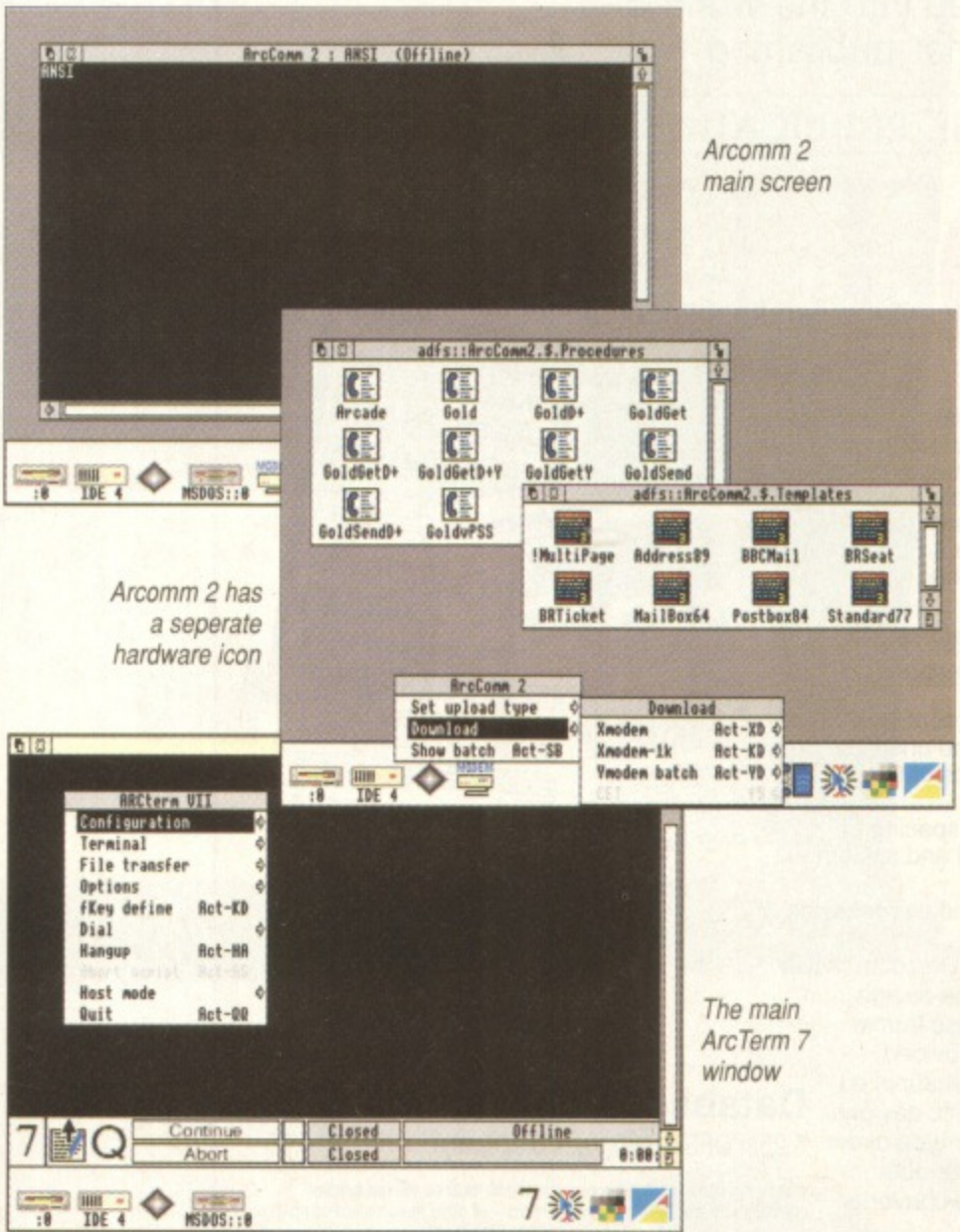

ArcComm 2 main screen

ArcComm 2 has a separate hardware icon

The main ArcTerm 7 window

# Personal Sound System



**Comprising:-**

- A cleverly designed interface and the latest high-velocity lightweight headphones
- Crystal clear sound reproduction
- Can be used in three different ways: headphones sound only, monitor sound only, sound on both headphones and monitor
- Interface features a tough plastic case with volume control
- You can also use the headphones with your personal stereo or hi-fi system
- Full instructions supplied to help you get the most out of this superb accessory

## Passing an exam . . . applying for a job . . . whatever you want to do in life you need to be able to SPELL!

There's mounting alarm about the appalling standards of spelling among Britain's schoolchildren. MPs, teachers, parents and employers are all stressing the vital importance of being able to spell correctly.

Yet most homes have what could be the ideal means of teaching spelling - the computer.

Instead of zapping aliens it could be turned into the best weapon of all to deal a body blow to bad spelling. With the help of a brilliant new software package that not only makes practising spelling painless

but also loads of fun as well.

SPELL! is unique. It lets the user learn at his or her own pace. They can take as long as they like - or take on the computer in a high-speed challenge!

And this one package is ideal for everyone - with the lowest age group suitable for under-5s, while the more advanced words will stretch even the most able students.

*It includes five different tests, each making use of more than 5,000 words - so much variety that you'll never get bored.*



- 5 DIFFERENT TESTS
- OVER 5,000 WORDS
- FOR AGES 5 TO 15

**SPELL! only costs £8.95. It is now available on disc and tape for six of the most popular home computers.**

PLEASE USE THE ORDER FORM ON PAGE 112

# FontStyle

Fontstyle is a versatile system for creating professional looking printouts. It comes with two ready-made fonts and a designer so you can create your own.

Plus you can now get a set of four discs containing an extra 64 fonts!

Fontstyle is so easy to use. You just type in your text using your favourite word processor - enter the easy-to-remember formatting codes and save it. Then just load in the FontStyle program and you'll have superb results within minutes.

**Some of FontStyle's features**

- Professional-looking results from 9 pin printers
- Simple to use
- Fast draft mode
- 64 fonts available
- Up to 8 fonts in any paragraph
- Print any font in different dimensions
- Temporary or hanging indents
- Dynamic control over page layout
- Flexible and easy-to-use font designer
- Ideal for letterheads, invoices, newsletters, memos and so on
- All popular word processors supported

<b>FontStyle</b>	
5.25in disc	£9.95
3.5in disc (BBC ADFS)	£10.95
Archimedes (Using emulator)	£11.95

<b>Set of 64 Fonts (4 discs)</b>	
5.25in disc	£14.95
3.5in disc (BBC/Archimedes)	£19.95

Take a step into the world of professional publishing with

## DATABASE PUBLICATIONS

# DTP

This is an easy-to-use and flexible page design system for producing high-quality printouts through your Epson compatible printer. It comes with four of its own fonts to get you started plus a Font Designer to keep you going.

**Some of the features of Database Publications DTP**

- Independent control of bold, italic, 'thin' and underline characteristics of the system font
- Proportional spacing of both external and system fonts
- Stretching and compressing of any area
- Pixel editing via zoom facility
- Up to A5 page design
- No special disc format
- Four fonts provided
- Font Designer supplied
- Built-in Graphic designer
- Import text or type direct
- Can import cut-outs
- Built-in Mode converter



**Database Publications' DTP**  
5.25in DFS 40/80 track disc (only) £14.95

Due to the complexity of the program the fill routines will not function correctly with the B+, Master or Compact - all other features are compatible



# Mastering the incompatible

*Martin Reed plunges into the swirling waters of PC emulation*

**C**OMPUTERS are almost indispensable in the modern world. They can perform all kinds of tasks from the simplest to the most complicated, quickly and efficiently. They have made a staggering difference to almost all aspects of life: Entertainment, business and saving lives.

The BBC Micro sets the standard in the classroom and throughout the education market, but in the business sector the ruler of the roost is the IBM PC and its clones.

Although the PC's operating system is based on one designed more than 10 years ago – an age-and-a-half in the computer world – and therefore lacks the finer points that we have come to expect from today's machines, its software base is almost limitless.

Businesses buy PC-compatible machines because there is software available to fit their requirement and software houses write for the machine because there is such a large number of users. It's a circle that has all but squeezed all other machines out of this market.

Many hardware manufacturers have tried to break the PC's grip on

this market but none has been more than marginally successful.

Moreover, it appears that this is the shape of the future: With the exception of, say, the Acorn Archimedes or the Apple Macintosh which have carved out their own niches, a machine that is not PC-compatible is likely to falter through a lack of suitable software appropriate to business applications.

It is, therefore, good business sense for any new machine – or an existing machine that wants to broaden its appeal – to offer the option of PC-compatibility, because it means that its software library is immediately widened.

Both the Archimedes family and the Master 128 offer the option of PC-compatibility, albeit in rather different formats.

The PC Emulator for the 32-bit Archimedes is a disc-based software package, because a machine as powerful as the Archimedes has no trouble emulating every aspect of the 16-bit PC.

The emulator for the Master 128, known as the Master 512 upgrade, is a board that fits inside the machine and is activated at the metaphorical flick of a \*CONFIGURE option.

**M**ANY Master 128 owners will be quite familiar with the Master 512 Upgrade, an internally-fitted co-processor board that offers a degree of compatibility with PC machines. This flexibility is ideal for someone who already uses a PC in the office and wants to take work home to be continued on the BBC Micro.

However, the Master 512 doth not a PC make, and there are a number of major and minor differences between the two systems.

The Master 512 User Guide  
Price: £9.95  
Supplier: Dabs Press, 5 Victoria Lane, Whitefield, Manchester, M25 6AL  
Tel: 061-766 8423

Not the least of these is that the Master 512 system uses its own special customised version of an operating system called Dos+, as opposed to the MSdos system used on conventional PCs and compatibles. This may be a major



difference, but in theory it need not be a major problem. Unfortunately, however, the standard Master 512 package suffers from the serious problem that has so unnecessarily dogged so much of the software bundled with the various Acorn machines – that of being released with little or no accompanying documentation.

A Master 512 owner who is already familiar with the world of PCs will soon work out the differences, but an absolute newcomer to this world can easily be left floundering.

Although there is quite a lot of information available about the way in which the emulated PC operates, for the newcomer it can be very difficult to find.

However, help is here at last in the form of the **Master 512 User Guide** – not from Acorn, but from Dabs Press, well-known supporters of the Acorn machines.

It is packed with so many tips and features, facts and advice, that the reader will quickly wonder how he ever managed to do without it.

One particular aspect is that the 8-bit BBC Master has a pretty tough time emulating the 16-bit PC, and not all IBM software will run on this configuration.



Acorn strongly recommend any Master 512 owner looking to buy software for this combination to try out the program before purchasing it, just to make sure that it is compatible with the 512.

This aspect is comprehensively dealt with by a software package by the name of Problem Solver (see below), but for the owner of the standard 512 system, compatibility is still a problem.

The Master 512 User Guide's answer to this is a list of PC software packages that were known to be com-

patible with the 512 at the time of going to press.

It is based strongly on one produced by Acorn themselves that I came across when the Master 512 system was first released, but it is useful to have it where it can be easily found when needed.

In fact, that statement can be applied to the whole book, because all the information contained therein falls so easily to hand that the reader quickly understands why the book has

been given such a definitive title – Acorn's manual of the same title just isn't in the same league.

Every aspect of the Master 512 co-processor and its emulation of a *real* PC that the Acorn manual attempts to cover, the Dabs Press equivalent explains in the fullest detail such that a novice can understand it but not such that an experienced PC user will find it long-winded or patronising.

### Summing up

To be fair to Acorn's book on the subject, it states that it is not pretending to be a definitive manual for the 512, but I can't help questioning the logic of offering for sale goods of such a technical nature without proper accompanying documentation.

In short, whether you're new to the PC game or an old hand who mainly wants to know the differences between the 512 and a conventional PC, there's almost certainly something in Dabhand's *The Master 512 User Guide* to help you along.

#### Problem Solver

Price: £25 (for PC format disc)  
Supplier: Shibumi Soft, R. Prof.  
Camara Sinval 138, 4100 Porto,  
Portugal.

**T**he Master 512 co-processor is ideal for any Master owner who needs to run programs written for the PCs. Many of the better-known programs work perfectly on this combination but some, however, do not.

Owners of the BBC B+ and Master 128, whether first-time buyers or ones who have upgraded from a Model B, will be familiar with the concept of software (in-)compatibility, when a new program will not load or existing programs suddenly fail to function correctly. In the PC world the problem is worse.

Anyone familiar with the PC area of computing will know that only IBM's own machines are truly PC-compatible, obviously. The various PC clone manufacturers, such as Compaq, Tandon and Olivetti, offer varying degrees of compatibility, and generally speaking, the less expensive the machine the less compatible it is. This, in turn, can lead to problems with the less well-behaved software packages.

The Master 512 is not particularly PC-compatible, partly because its operating system software is Digital

Research's Dos+ as opposed to Microsoft's MSdos. Although Dos+ 1.2, the version first supplied with the board, was later replaced with the more compatible version 2.1, certain standard pieces of PC software have steadfastly refused to run.

Furthermore, the IBM PC's keyboard is quite different to that of the BBC and Master – both in terms of layout and the way in which key depressions and releases are scanned – and it is in this area that some of the major compatibility problems arise.

Until now, the 512 owner has just had to accept that some programs will not work – whether correctly or at all – but be thankful for those that would. But no longer. **Problem Solver** from Shibumi Soft, also known for their Archimedes Pinball, runs in conjunction with Dos+ and attempts to bridge this compatibility gap.

And it does it very well. Many previously unusable business and utility programs, such as PC Tools Deluxe, the Pipedream wordprocessor and version 2.0 of the Lotus 1-2-3 spreadsheet, suddenly spring into life.

Other packages that previously did not work at all now work to a degree. One example is WordPerfect v4.2, which works in all respects with the exception of the tutorial.

Problem Solver will also win many friends among programmers, because many of Borland's Turbo languages –

Basic, Pascal, C and the like – now run on the 512 system for the first time.

The Master 512 owner can also now dabble with Cobol/2 – Micro Focus' implementation of the language that is still probably the most widely used in business programming.

Of course, business and education are not the only uses to which a computer can be put, and many PC games also benefit from Problem Solver.

Readers of the Hac Man games column may remember the tip featured in the November 1989 issue, to allow the Mastertronic version of Rogue to run on the Master 512. But Rogue is by no means the only game that will now run correctly on this combination.

Microsoft's Flight Simulator is often used as a simple test of PC-compatibility: If a machine runs it, it's pretty compatible. At the time of writing I have not been able to test Microsoft's latest version, Flight Simulator 4, but many earlier versions now run on the Master 512.

The name *Elite* will be well known to all BBC Micro users: Much imitated, it has been converted for almost every machine under the sun, including the PC.

Without Problem Solver, *Elite* loads as far as the rotating Cobra, then locks up and will not accept any input from the keyboard.

In addition, the ship rotates extremely slowly: This apparent dra-

matic loss of speed is another problem previously faced by the Master 512 owner. However, with Problem Solver, *Elite* is back with a bang, four-colour solid graphics and all.

A number of other games, such as *Starglider*, *Driller* and *PSI-5 Trading Company*, also run on a *Problem-Solved* Master 512, but potential purchasers of PC games should note that many modern offerings will only run on machines with at least 640k ram and/or an EGA or VGA graphics board. Let the buyer beware.

Problem Solver is not perfect. Some packages, particularly the badly-behaved memory-resident ones, such as the more recent versions of Borland's *Sidekick*, still do not work on the Master 512, even with Problem Solver loaded.

However, it makes such a staggering difference to the compatibility rating of the Master 512 that most users will be prepared to overlook the slightly inaccurate title

### Summing up

The 512 co-processor is now officially discontinued, but if you've got one then without a shadow of doubt you need Problem Solver – it's what the 512's been waiting for.

# IMPRESSION III



# Hold the front page!

**C**omputer Concepts, who are at the forefront of DTP innovation for the Archimedes and BBC A3000, are offering more than £750 worth of prizes to readers of *The Micro User* to celebrate the new addition to their stable – Scan Light Junior 256.

● **First Prize is Scan Light Junior 256, worth £258.50 and the latest in a quality line of hardware released by Computer Concepts over the last few years.**

Scan Light Junior 256 is a development on the original scanner, and offers a range of facilities vital to any serious DTP user.

Utilising 256 shades of grey, this scanner is of professional standard but is available for a fraction of the price you would expect to pay.

● **Second Prizes are two copies of Impression 2.1 worth £198.57 each.**

Arguably the most flexible DTP package available for the Archimedes, Impression is also one of the most popular word processors.

This latest version includes automatic timed saving, crop-mark printing, virtual rules for tables, sidebars and the like to mention but a few of its features.

● **Third Prize is Impression Junior, worth £105.69**

Though offering fewer of the more intricate features, Impression Junior doesn't skimp on quality.

Ideal in both schools and the home, you'll find that you can format as you type, flow text automatically around graphics and choose from a huge array of print options.

**What to do**

To win one of these excellent additions to your Archimedes you have to answer the following questions and complete the tie breaker.

Then fill in the entry form and send it to *The Micro User* by October 31. The first four correct entries with the most humorous or original tiebreaker will receive one of the prizes.



*You can win one of four great DTP products in our super competition*

## The Questions

- 1. What does dpi stand for?**
  - (a) dimensions preceding impression
  - (b) decidedly permanent imprint
  - (c) dots per inch
- 2. Which is the larger paper size?**
  - (a) A1
  - (b) A2
  - (c) A3
- 3. What is kerning?**
  - (a) changing the space between letters
  - (b) changing the space between lines
  - (c) changing the space between paragraphs
- 4. What is a dongle?**
  - (a) a printer lock
  - (b) a switchable icon
  - (c) a copy-protection device

## ENTRY FORM

Name \_\_\_\_\_

Address \_\_\_\_\_

Postcode \_\_\_\_\_

## ANSWERS

1.  2.  3.  4.  5.

### Tiebreaker

The first thing I would scan with my Scan Light Junior 256 would be: *(less than 25 words)*

\_\_\_\_\_

\_\_\_\_\_

\_\_\_\_\_

Send the completed form by October 31 to: Computer Concepts Competition, *The Micro User*, Europa House, Adlington Park, Macclesfield SK10 4NP.



*Steve Turnbull takes a look at a new concept in inter-program communication on the Arc*

# Acting on Impulse

**H**OT-LINKS between programs can be useful, because they allow one program, say a spreadsheet like PipeDream, to produce graphs, when hot-linked to Presenter, without the programmers having to complicate PipeDream itself with the ability to produce graphs.

But there's a serious disadvantage with this type of hot-link approach: What if you don't own Presenter but a different graph-drawing program? Or you own Matrix-3 and Presenter, but not Pipedream?

Acorn have provided an inter-application communication messaging system which allows the hot-links to work but these are designed for programmers, and they're not available – or comprehensible – to the average user.

Enter Computer Concepts on white charger brandishing a sword named Impulse and the shield of compatibility.

Impulse – or more accurately Impulse II – is a high-level application control system for Risc OS which allows simple text messages to be sent from one task to another. The key feature is that the messages are textual, which means that you, the user, can understand it and, more importantly, you can control it.

Let's say you have a wordprocessor (WP) and a database (DB) and want to perform some mailmerging – sending lots of identical letters to your customers.

So you write the letter in the wordprocessor but where the name and address is supposed to go you instead, using a special option provided by software, insert Impulse commands which might be:

```
:DB.Addresses GetField surname
```

The first part is the name of the task that is to receive the command *DB* followed by the name of the database to use *Addresses*, the actual instruction *GetField* and finally the name of the field being requested,

*surname*. Control of the mailmerging process could be either the database – which is most likely – the word processor or even a third program which would cycle through commands like:

```
:DB.Addresses NextRecord
:WP.Letter Merge
:WP.Letter Print
```

The *Merge* command tells the wordprocessor to scan through the document looking for embedded Impulse commands which it should then issue and place the returned information into the letter in the appropriate place, properly formatted.

The wordprocessor sends a reply back when it has finished merging data into the document and the control program then tells it to *Print*. Finally it goes back to the database and tells it to move on to the next record.

The wordprocessor that's used could be Impression, EasiWriter or any one that responds to these commands. The database could be Squirrel, Multistore or any other one with the same methods. But it's you who controls it, it's not *hard-wired* into the software.

But this simple mailmerging example is only the start, the PipeDream/Presenter hot-link could be quickly replaced with a gener-

alised Impulse command like:

```
:Grapher DrawGraph "Fred" "Jim"
A1|C12
```

This tells the graph drawing package to produce a new graph called Fred and use spreadsheet cells A1 to C12 to do it. The graph program would then have to request the cell information from the spreadsheet with:

```
:Spreadsheet.Jim GetCell A1|C10
```

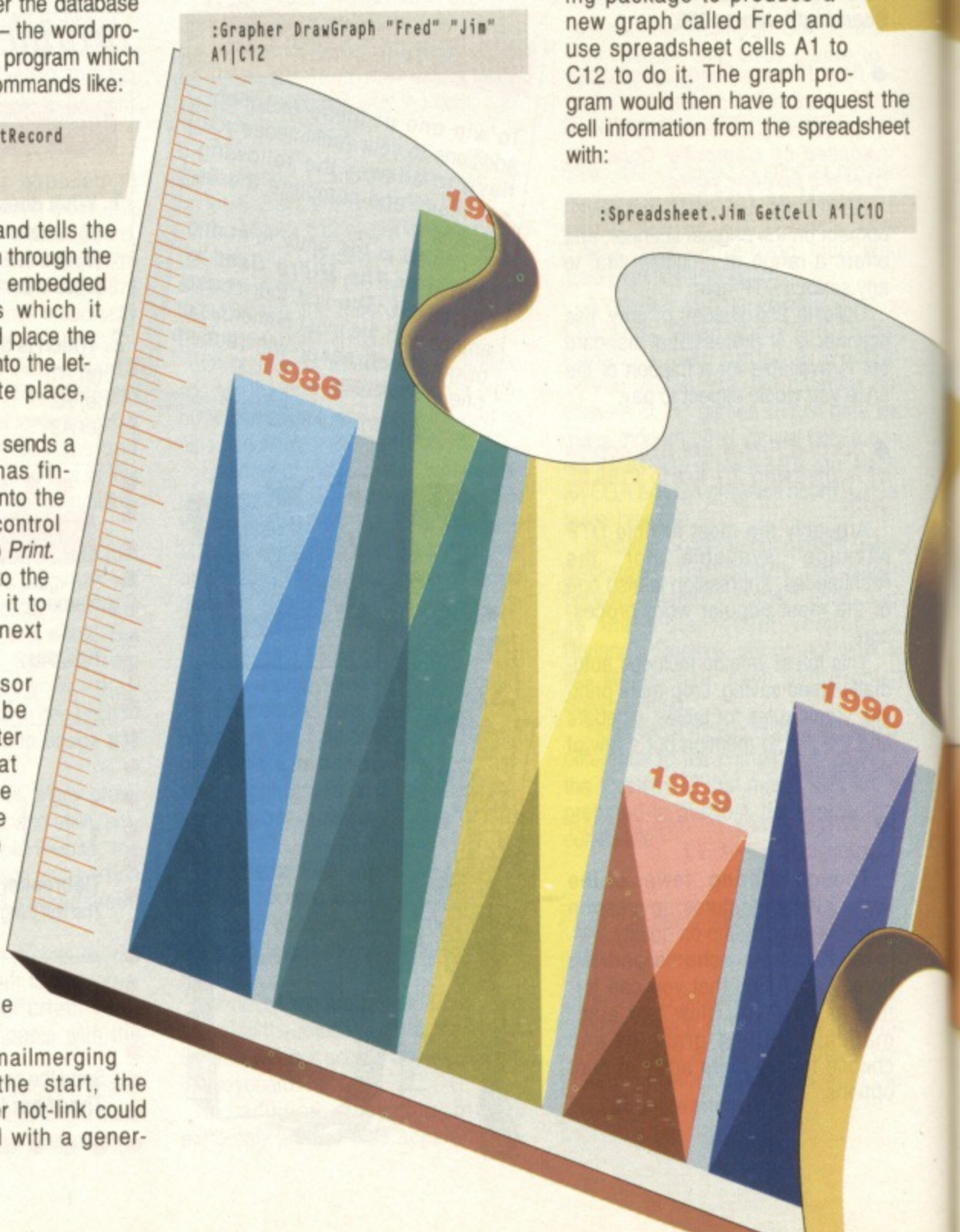





Once the graph was finished the first instruction would be acknowledged, the spreadsheet might have the ability to send drawfiles so it could then ask for the final result with:

```
:Grapher SendGraph "Fred"
```

These examples are completely invented, but they show the kind of thing that's possible with Impulse.

Going back to the mail-merging example there's absolutely no reason why the data need come from only one source, it could be merged from more than one database, from a spreadsheet, drawing program – the combinations are limited only by your needs.

As it stands, on a single machine Impulse provides a means of allowing you to combine different packages into something bigger and better – the whole then

becomes greater than the sum of the parts: Combining a DTP program with a database gives you a database with incredibly sophisticated printing facilities – or is it a DTP program with database power?

But Impulse doesn't stop there, what if your machine is part of a network and you want to work with data on a different machine?

That's easy too, the name of the application to receive the command can also include a network address:

```
:Econet.Fred.MultiStore.Users
```

This translates as database *Users*, from application *MultiStore* on the machine called *Fred* which would be on the local Econet network.

```
:Net.PhoneLink.Egypt.Squirrel.Addresses Getfield surname
```

In this example the database is quite a long way away.

## Impression's methods

Each application that supports Impulse must have the following sort of information in its help file, it describes in a fixed format what commands (methods) it supports, the syntax of each command and what it does.

### Merge

Commands Impression to start a merge operation in the specified document. Impression will reply to this command when all the merge data has been received from other servers and has been formatted into the document.

### Print

Commands Impression to print the specified document. The print operation uses whatever controls were set up in the "Print" and "Print setup" dialogues when it was called. A reply is sent when the print operation has been completed.

### Edit [on|off]

Enables an outside application to prevent an Impression document from being edited. This is useful when the document contains merged data which should not really be edited by the user.

- Edit on puts the document into its normal, editable state. It also removes any merged data from the document.

- Edit off prevents the document from being altered in any way by the user. The mouse pointer will turn into a large red cross symbol when it is moved over the document

- Edit returns the state of the edit flag for the specified document. The reply message will contain "on" if the document is editable, "off" if not.

### ClearMerge

Gets rid of the merge elements from the specified document, leaving any merged data intact. It should usually be called before "Edit on" because that command removes the merged data wherever it finds merge elements.

## Terminology

**Application:** A task which displays windows, icons and menus to communicate with the user.

**Class:** The name of a group of objects which all respond to the same methods in the same way.

**Client:** A task which requests another one to do something for it.

**Conversation:** A sequence of one or more messages passed between two tasks. A conversation is always started when an Impulse command is used.

**Method:** An operation that can be performed on an object by a server, that is the substance of an Impulse command.

**Object:** A distinct entity owned by a server. Only the server which owns an object can do anything to the object. Examples are Impression documents, MultiStore databases.

**Server:** A task which performs operations on objects at the request of other tasks. Examples are Impression and MultiStore.

**Task:** A program running under the Risc OS on the DeskTop

## Summing up

An idea of this type is only as useful as it is supported by the software writers. Computer Concepts invented it, but to develop it to its full potential they are consulting with the rest of the Acorn community.

Minerva are releasing an updated version of MultiStore which will control mailmerging with Impression or any wordprocessor that responds to the same commands in the same way. Digital Services are adding to Squirrel to incorporate Impulse.

In the face of the recent development of Direct Data Exchange – DDE – on the PC and *AppleEvents* of the Apple Mac System 7, Impulse is a vital enhancement to the Risc OS messaging system and supporting it will strengthen arguments in favour of Acorn machines.

# A VOID BROMLEY!

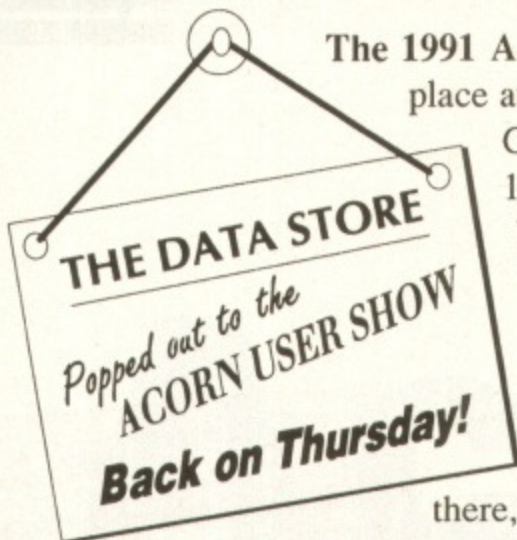

The 1991 Acorn User Show takes place at Wembley Conference Centre from 11th to 13th October and we'll be on stand 113 with a wide selection of products and some new Data Store Software releases! BUT whilst we're there, we are closing our

Bromley showroom for refitting. In fact, we'll probably be closed from *Wednesday 9th till Wednesday 16th October inclusive*, but just in case we manage to reopen more quickly, we'll be leaving our answerphone on to give the latest information, so please ring before you come. Once we're back, you'll be able to enjoy our famous service and hospitality and our large range of products for all Acorn computer systems in an even more delightful environment - we look forward to seeing you then! Until 8th October, you'll just have to put up with the *old* carpet...

## THE DATA STORE

6 Chatterton Road, Bromley, Kent BR2 9QN.  
Tel: 081-460 8991 Fax: 081-313 0400

## ArcModem

A brand new 2400 baud pocket sized modem for the Archimedes/A3000

- Fully Hayes compatible
- BELL 103/212A
- CCITT V.21/V.22/V.22bis
- Protective cover
- Elegant design in compact size
- Mains or battery powered
- Intelligent power saving circuit
- Long battery life

Comes complete with drivers for ArcTerm\* versions 6 and 7.

ArcModem, Mains adaptor, 9v battery, leads and driver software:

**Only £169.00**

\* ArcTerm 7 is a fully multitasking coms package. Available from: The Serial Port, Tel: (0243) 531194

## The RTFM Joystick Interface

The Interface allows up to two 9 pin Commodore® or Atari® style joysticks to be connected to your Archimedes/A3000. The interface fits inside your machine, though it does not require a podule slot.

The RTFM Joystick Interface has support from 4th Dimension, Eterna, Krisalis Software, Cygnus Software Engineering, Clares Micro Supplies, Cambridge International Software and Minerva Software

Over 40 Archimedes games currently work with the Joystick Interface, and you can even control games running under the BBC Emulator!

**Only £34.95**

## Archimedes/A3000 Games

- Poni! (£17.95, seriously cute, and 9/10 from Micro User)
- Brixi! (£17.95, the most irritating tune in history, and Micro User gave it 9/10)
- Slappit (£17.95, ever tried playing football, snooker and pinball at the same time?)
- The Arc/A3000 Winter Box (£19.95, pack includes: Poni in Winterland, Brixi and Zap the Red Wierdos from Mars)
- Dominate (£19.95, can you find the solution?)
- Recall (£14.95, test your powers of memory and deduction)
- Bouncer (£19.95, fast action arcade game, out soon)



RTFM, 43 Hill Street, St Helier, Jersey  
© (0534) 67870, Fax (0534) 68996.



## MASTER COMPACT CARTRIDGE ADAPTOR

Connects MASTER and ELECTRON cartridges (including our ROMPlus-144) to the COMPACT - Price £25. SAE for details

## INCREASE ELECTRON PERFORMANCE AND BBC COMPATIBILITY WITH OUR RANGE OF ADD-ONS

### E2P SECOND PROCESSOR

Gives the Electron equivalent performance to a BBC with a Second Processor. Adds a complete processor with its own 64k memory bank to run all programs while the Electron handles screen, keyboard, discs, etc.

Gives 30k memory for BASIC programs and 44k memory for HIBASIC programs. (Electron HIBASIC available separately) Gives up to 300% speed increase in programs. Fits into a Plus One/ROMbox Plus slot.

Operating system available on ROM or 3.5" ADFS disc or Tape (state requirement)

Price £79 + £5 for case.

### MODE 7 Mk2 UNIT

Gives exactly the same Mode 7 display screen as the BBC. Allows BBC Mode 7 software to run on the Electron: Magazine programs, Adventure games, Educational, Wordwise, Prestel, Teletext. Includes Prestel software - Prestel requires a modem and our RS423 adaptor. You will need a ROM socket to hold the Mode 7 ROM, eg. in our RS423 adaptor. For Mode 7 programs with HIMEM above &4000 you will need a Shadow RAM board. Fits inside the Electron, alongside the Shadow RAM Board.

Price £49 for you to fit, or £59 fitted.

Also available as a kit - board and ROM for £25 - you buy the components.

### RS423 SERIAL CARTRIDGE

Connects the Electron to serial RS423/RS232 devices, eg. printers, modems. Allows the transfer of programs, data, etc. from one computer to another. Has the same socket, so uses the same leads as the BBC. Includes a socket for a 32k RAM or 16k ROM, eg. the Mode 7 ROM. Fits into a Plus One/ROMbox Plus slot.

Price £29.95 + £5 for a case + £20 for a 32k RAM.

### ROMPLUS - 144 ROM CARTRIDGE

Sideways ROM cartridge with Printer Buffer and RAM Filing System. Holds 8 ROMs or 7 ROMs and a 32k RAM. Fits into a Plus One/ROMbox Plus slot.

Price £39 + £20 for a 32k RAM

All prices inclusive of post, etc. - Please allow 28 days delivery.

## WE ALSO REPAIR ELECTRONS

**Jafa Systems**  
4, Caebedw, Caerphilly  
Mid-Glamorgan CF8 2UU. Tel: 0222 887203



## UNIVERSAL TELETXT ADAPTOR

- \* RISC-OS version multitasks.
- \* Computer controlled tuning.
- \* Download and save pages.
- \* User programmable via SWIs & OS calls.
- \* Unique composite video & audio output.
- \* High performance T.V. front end.
- \* Fully mains powered unit in metal case.
- \* Upgrades available for existing users.



Reviewed in Acorn User, June 1991

The ARC/A3000 version contains many powerful features making it very easy to use, i.e. point and click at page numbers. SAE for details.

Prices include:-

User port lead  
SATS Software  
User notes  
BBC B  
£77.00

Parallel port lead  
TTX V1.08 S/ware  
User notes  
A3000/ARC  
£77.00

Podule socket lead  
TTX V2.11 S/ware  
User notes  
A3000/ARC  
£77.00

## A3000 MEMORY UPGRADES

- \* Low power design, only 8 chips.
- \* 1 Meg upgradeable to 4 Meg.
- \* Easy to fit, just plugs in. +
- \* Screw fixed for reliability.
- \* PCB size only 175 x 50mm.

1 MEG £70.00 inc VAT & P+P

(Gives 2 Meg total memory)

4 MEG £170.00 inc VAT & P+P

(Gives 4 Meg total memory)

NOTE: Memory prices fluctuate, please phone for our best quote. SAE for full details

## ARM 3 PROCESSOR

- \* Cache operation at 25 MHz.
- \* RISCOS IArmspeed software.
- \* 3 + times speed increase.
- \* DIY plug in design.
- \* Fits A300/400 series.

£299.00 including VAT + P&P

## A305/310 4 MEG MEMORY UPGRADE

- \* Low power 8 chip design.
- \* DIY fitting, just plug in.
- \* Accepts our ARM 3 processor.

£260.00 including VAT + P&P

SAE for details of above products



DEPT MU9.  
GROUND CONTROL  
ALFREDA AVENUE  
HULLBRIDGE  
ESSEX SS5 6LT

TEL: 0702 230324



ALL PRICES INCLUDE  
VAT AND P&P  
MAIL/TELEPHONE ORDERS  
ONLY PLEASE  
EDUCATIONAL AND  
GOVERNMENT ORDERS  
WELCOME

Product: Junior Database  
 Price: £53 plus VAT, education price  
 £39.95 plus VAT. Site licence  
 available.  
 Supplier: Iota Software, St John's  
 Innovation Centre, Cowley Road,  
 Cambridge CB4 4WS.  
 Tel: 0223 421542  
 Requirements: BBC A3000 or  
 Archimedes range

**W**HEN I first encountered this package from Iota I assumed it was directed towards the education market place. And indeed from the amount of help and comments within the manual Iota seem to see this as its niche.

Yet once I started working through its excellent tutorial and very professional manual I realised this is to do it an injustice.

It's easy to use and starts with basics, so is a good introduction for anyone new to either computers or databases, however its uses go far beyond the classroom.

Most people fall into the trap of booting up a disc and exploring a pro-



The protection window

gram without even opening the manual. Should you be so tempted with the Junior Database you'll find a tutor on the disc to help you – in fact you can manage very well without the manual.

The tutorial starts with a good introduction to handling the Archimedes, with an explanation of the different mouse buttons. However, waiting for the individual screens to load is a little time consuming.

Once you get into how to make the Junior Database work for you this help/tutorial really comes into its own.

The program is fully multi-tasking and intuitive with one of the best interactive help screens I've ever seen. You load the files as it instructs and it waits for your input before continuing and/or acknowledging what you have just done.

At any time you can press the rewind button to recap on a point, or if you are lost, click on the H for more help.

I did have a couple of problems with my machine which resulted in the program throwing me out. Yet as I re-entered the tutorial – giving my name – it returned me to the point at which I exited. Each item is ticked as you cover it on the menu, from a general introduction through to searching and sorting.

The pre-created files, supplied to help you through the tutorial and manual, are excellent resources for teachers and provide good examples of possible layouts for everyone else.

Junior Database is divided into two

parts, layout editor and the data editor. Clicking on the icon-bar icon reveals the layout editor.

The secret of all database structure is to think in advance about what you need immediately and may need in the future, what information are you likely to need to access and if there are fields to contain all that data.

With this package you can add new fields once the layout is complete, but even so it's best to plan ahead.

### Data decisions

You access the menu and follow the options to create a new field, colour it, change its size or type. Do be wary about data types – by choosing numbers only you'll not be able to add text characters or even spaces, if in doubt leave a field to accept text data.

Iota have struck a happy medium with the options. You can have input centred or left or right justified and you can pick up the fields and move them where you want.

This can be done using the select menu or through short cuts such as using the Shift key and adjust button to highlight several fields and then edit them as you see fit.

There is a particularly useful option

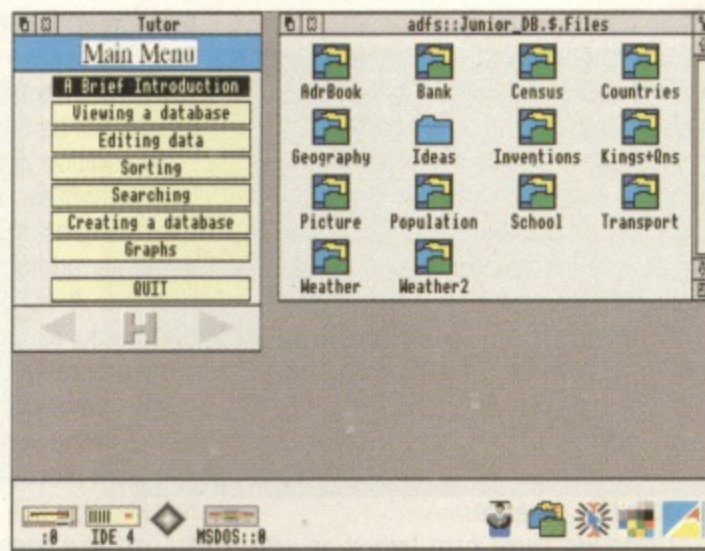

The tutor menu

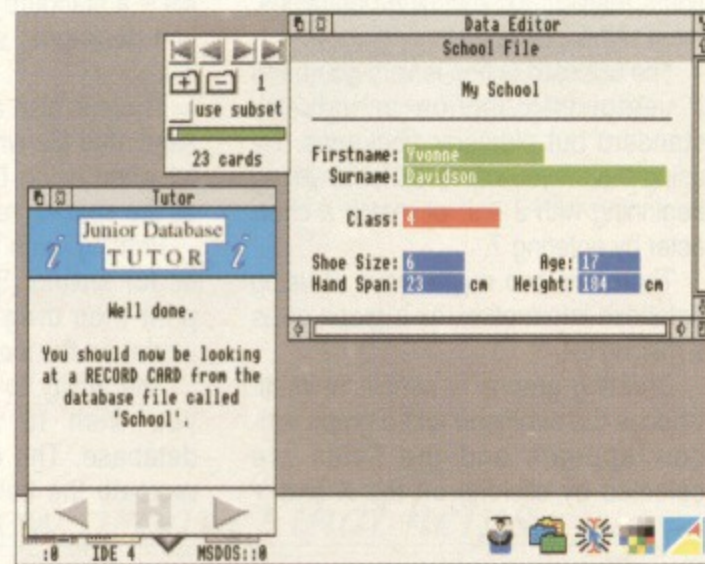

Following through with the tutor

to add text and move it where you wish – this could be a comment or a piece of advice such as "Please show STD codes".

Assuming that you've now created and saved your layout the next task is to enter the data. By double clicking on the saved file you automatically enter the data editor.

It doesn't matter whether you enter the text in upper or lower case as searches and sorts ignore case – although an option to add this would have been handy. Editing is equally straightforward.

The toolkit can be restricted at the icon bar stage if you wish, but in its full state you can go straight to the back or front of a file, step through to enter the number of the data card you want.

A scroll bar also tells you where you are in the file as well as how many files there are in all and the number of the one you are viewing. As you leave a new or edited file that record is automatically saved

The manual could have been a little more helpful in the searches and sorts department. To sort a file, usually into alphabetical order, you enter the sort sub-menu to be presented with a sort card – a duplicate of the basic layout with the addition of four

# A lot in a little

Jo Giles examines the intricacies of Iota's Junior Database



REVIEW

option buttons with which the records can be placed into ascending or descending order.

You can also decide which field you want to sort on – though surname is obvious, it could be on county or population. Two selection criteria can be selected.

Searching is more extensive, with a choice of a variety of searches: simple, wildcard, match any field, or expression matching where you can find someone with <100 in their bank account for instance.

Using the same card format as with sorting, there's a different set of additions relevant to searching databases, most self-explanatory.

The wildcard option is very good and a useful introduction to industry standard but clumsier packages. By using \* or ? you can look for anything beginning with J – J\* or match a character by entering ?.

There are two major ways of using database information, as a graph or as a mailing list.

Creating graphs is simplicity itself. Choose the submenu and a graph window appears and the fields are selected by clicking on the X and Y

axis icons. Depending on the type of data chosen – number or text – the options of bar, pie, scatter or line graphs will be made available.

In addition one graph can be overlaid on another. Graphs can be two or three dimensional or even outlined for manually adding colour once they are printed. A number of save options allow you to use the information in other programs.

The save options are comprehensive allowing you to save a card for use in a word processor as a draw, sprite or text file. You can also print blank forms, for use as a questionnaire for instance.

Information can be saved as a CSV file – a standard file used in presentation packages, spreadsheets and the like.

There is also an option to use a tab separated file which is especially useful when using DTP or spreadsheets, as the spacing remains intact.

Printing uses the same procedures as for saving. Save the fields to be print then drag the text icon to the printer on the icon bar.

The ability to import files is vital if you wish to modernise an old database. The easiest method is to recreate the fields then drag the file

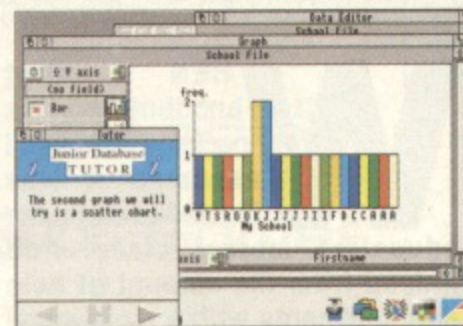
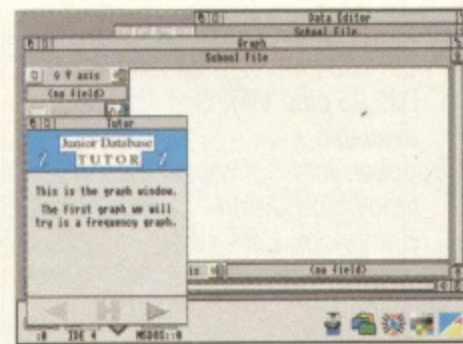
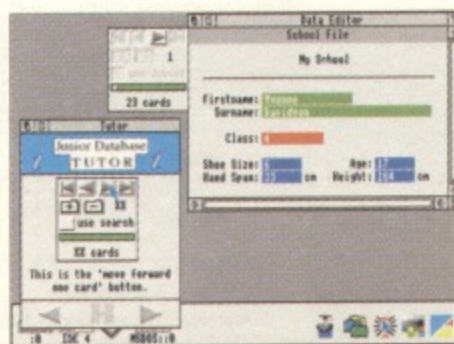

on to the empty database in either CSV or TSV format. A mapping window will appear showing how the data will be added into the new layout.

The mapping fields are editable and any errors which occur will be shown in a window allowing you to edit a particular line, blank to the end, or give up.

Alternatively you can drag the data file on to the icon bar. Junior Database will try to recognise it and decide on the maximum length of each field showing its proposed layout.

Merging is simply a matter of dropping one Junior Database file on another and letting them get on with it. A mapping window will appear for your approval. It is even possible to merge non-Junior Database files too.

### Summing up

Junior Database is surprisingly powerful with features lacking in some more expensive and harder to use packages. You need no expertise to use this package and as an introduction to and example of what the Archimedes can do it is superb. Buy it – you'll not regret it.

THE MICRO USER

Reader offers

THE MICRO USER

Reader offers

NEW

# DATABANK

An electronic personal organiser, for only £24.95

This superb pocket size (2 1/4" x 3 1/2") databank provides a host of features:

- Diary scheduler
- Memo function
- World clock across 24 time zones
- 10K memory
- Alarm (with message feature)
- Comprehensive Calculator
- Paperless printer for reviewing entries
- Address and telephone number storage
- Full 12 month warranty

Comes complete with leather pouch and full instructions

To order, please use the form on Page 112

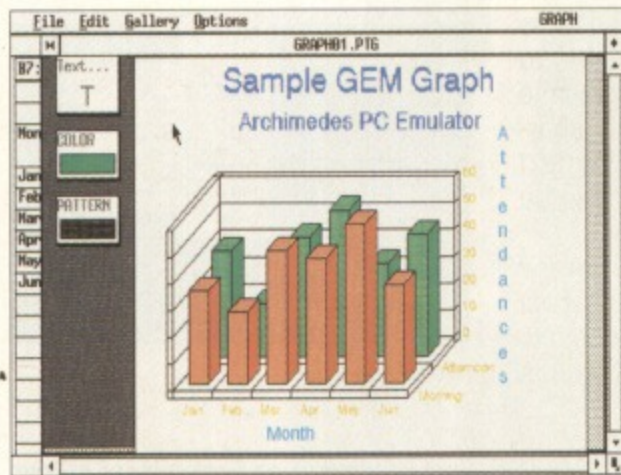

Using Gem

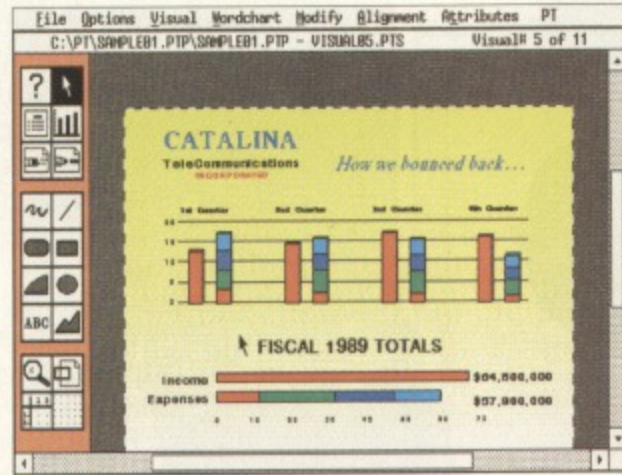

The mouse works perfectly

	A	B	C	D	E	F
1		Carpets Superstore				
2		-----				
3						
4		Frank	Susan	Amanda		Totals
5						
6	Minister	125.46	75.68	156.54		357.68
7	Foan back	245.35	352.57	135.78		733.70
8	Vinyl	86.64	85.24	75.35		247.23
9	Wilton	56.88	36.75	24.97		117.72
10	Luxury Cord	124.58	267.89	324.57		717.04
11						
12						
13	Sales per person	638.83	818.13	717.21		2173.37
14	Commission % rate	4.00	6.00	7.00		
15						
16	Bonus payment	25.52	49.89	58.28		124.81
17						
18						
19						
20						
21						
22						
23						
24						
25						
26						
27						
28						

SuperCalc 5

# Amazing emulation

Product: PC Emulator  
 Price: £99 plus VAT  
 Supplier: Acorn Computers, 645  
 Newmarket Road, Cambridge  
 CB5 8PD  
 Tel: 0223 245200

**T**HERE was an outcry when Acorn announced some time ago that it was abandoning development of a PC-on-a-card for the Arc and only intending to provide software emulation. Surely no mere software could emulate MSdos without sacrificing too much speed?

With the launch of the latest version of the emulator that outcry has diminished to an occasional whisper as the programmers have proved the sceptics wrong.

The new PC Emulator package comes supplied with a well-written and printed manual and three disks. One contains MSdos itself with all the attendant utility files.

Of the other two you only normally require one – either the emulator for CGA single-tasking or the MDA/CGA/EGA multi-tasking version, depending on the amount of memory available. You need at least 2Mb for

the multitasking version. The multitasking system was very easy to install over the existing version.

The System and Fonts directories needed updating, and being done automatically by the Merge application. And having allocated 10Mb from my hard disc for a drive C, I decided that I wanted to increase the amount of space for the emulator, so at first I started to create a drive D of 5Mb.

I then changed my mind, went back one stage and decided to

increase drive C's capacity to 15Mb. A warning message appeared about current files being deleted, and unfortunately I assumed this meant the new drive D file.

I confirmed my action, and promptly erased all the files that I had already put on drive C – it had no effect on Arc files.

This is no fault of the emulator, but it is worth remembering that if you do decide to alter the size of the hard disk, low-level reformatting has to take place and your files will be lost.

In some situations Dos will accept the command SYS to transfer the system files – necessary for booting from the hard disk.

If it does not, then FDISK and normal formatting is needed. This is explained in the manual, and within 10 minutes I had the new system installed and booting correctly.

The new emulator looks and feels completely different from its predecessor. It only requires a double-click on the PC icon to load the emulator on to the icon bar.

Before using the emulator you need to set various options you can specify how much memory the emulator is to be allocated (normally 640k), what drives are available, and the type of display adaptor required.

The PC world has many display standards and the emulator is capable of working with four: CGA, EGA, EGA+ and MDA which uses the least memory. Owners of multi-sync monitors can select ECD for enhanced colour display. Note that the configuration can only be altered when there is no PC window open.

From the icon bar a single click opens a window into the PC world. The window acts just like any other Risc OS window and can be rescaled, put to the back, scrolled and closed.

Once the window is highlighted you are switched into the Dos environment and commands entered from the keyboard react as you would expect from a PC.

A utility program called AMOUSE.COM is included that causes the Arc mouse to behave like a Microsoft Bus mouse, enabling PC programs to take advantage of mouse control.

This command is best placed in the AUTOEXEC.BAT file so that it is loaded automatically on boot-up.

Two other utility programs PUT-FILE and GETFILE have been included for file transfer between Risc OS and Dos, but for most situa-

*Paul Hendy examines a new product that helps the Archimedes think down to the level of a PC*

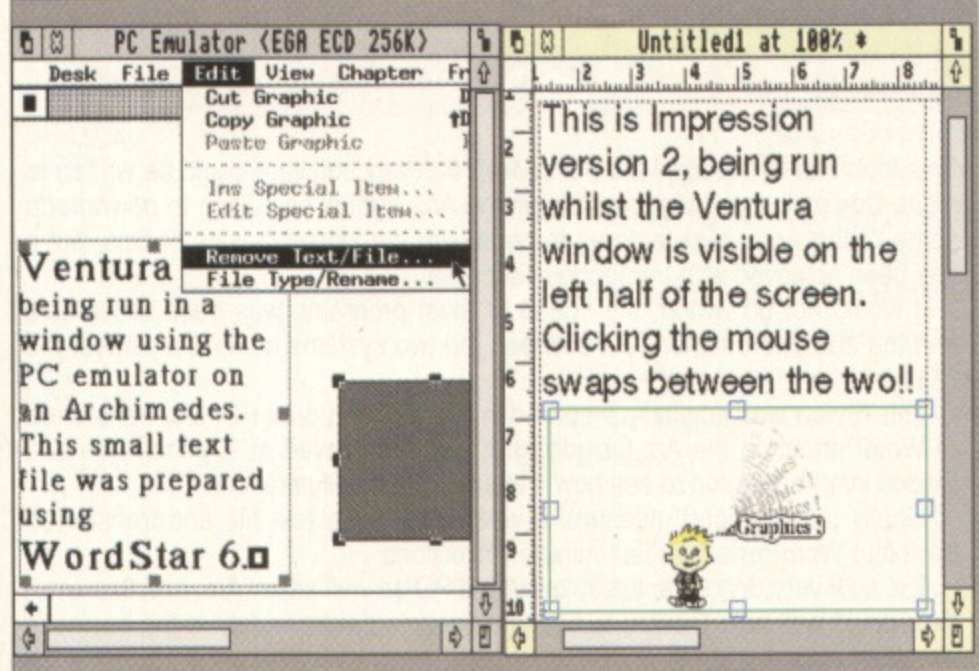

Ventura 2 vs. Impression?

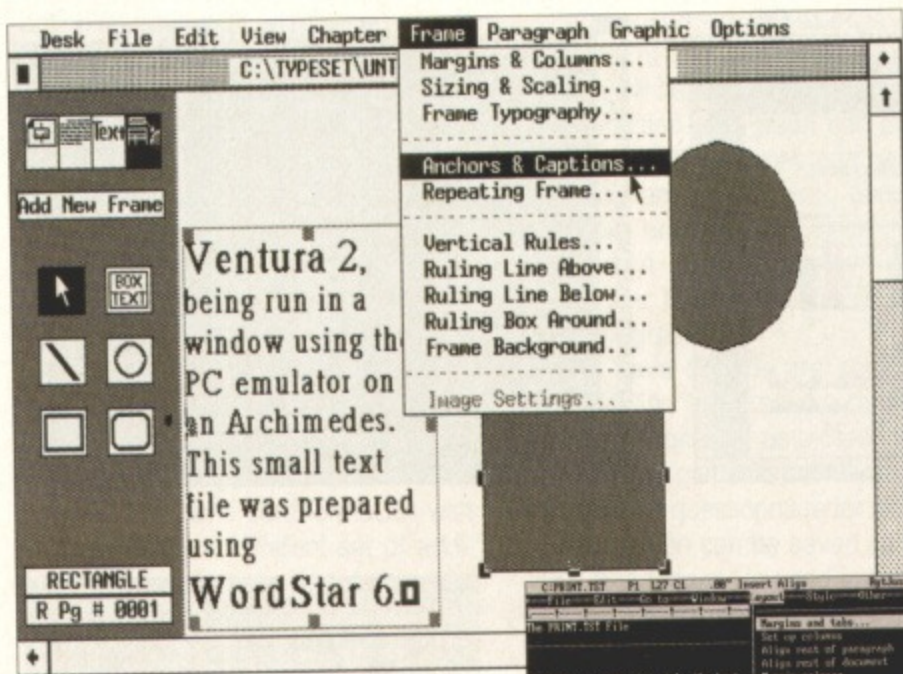

Ventura 2

tions these commands have been superseded by the MultiFS application and have only been included for compatibility with previous emulator versions.

It is irritating that the backslash key on the Archimedes is not positioned on the left of the keyboard, as Dos makes heavy use of it, particularly when controlling directories, and experienced PC users may have to re-enter commands on a regular basis.

### Testing standards

There is an unfortunate trend in software houses that programs have to grow, for example the original WordStar and dBase each came on a single discs. Now the latest version of WordStar is supplied on 28 of them.

As one of the slowest aspects of emulation is disc read/writes, installing Dos programs on to the Arc for testing takes a very long time. It is important to read the relevant note about full and heirarchical filenames as this will affect the speed of the copying process.

Any emulator claiming to be Dos compatible must be capable of running the standard range of PC packages. Without doubt the grand-daddy of all wordprocessors is WordStar, now in its sixth version.

Installation was simply a question of copying all the disks into a suitable directory, and it loaded without fault.

It was deliberately installed for monochrome, even though being run on a colour monitor, to check that the emulator coped with *bright white*, which it did.

All the drop-down menus and CTRL key commands worked correctly, and even the new page preview - which switches the monitor into

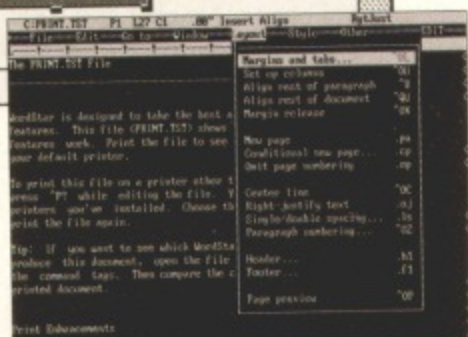

WordStar 6

graphics mode and displays a true representation of the document on the screen - worked as expected.

The business world is rapidly moving over to WordPerfect 5.1 so this was the next program to be tested. Once again installation and operation were faultless, and the mouse performed correctly.

Page preview was a little slow, but speeds were being compared to a very fast 386 computer. If compared more fairly with a 286 or 8086, the speed of the emulator is very impressive.

WordPerfect is able to access F11 and F12 on the extended AT keyboard, but the corresponding keys on the Arc did not work, and the duplicates of Alt+F3 and Alt+F4 had to be used.

One of the best spreadsheets for the PC is SuperCalc 5 and this again behaved perfectly under the emulator. There was no noticeable reduction in speed compared to a 286, and all the colours were reproduced faithfully.

SuperCalc has a comprehensive graph drawing capability and while these drew to the screen more slowly the reproductions were faithful and all options were available.

The emulator is capable of storing the entire PC screen as either a Sprite or as a text file. The text file option means that characters can be edited after they have been stored. The Sprite files can be used with Paint or Impression and all colours were preserved.

Testing both options with SuperCalc produced perfect results.

However the entire PC window is stored, and it was not possible to select only a portion of the screen to save. Consequently graphics characters were saved as strange text characters and these needed to be edited out.

Clearly a more severe test of the emulator's compatibility was needed. Enter Gem, one of the contenders to win the graphics front-end battle in the PC market.

Digital Research have just launched version 2 of their Presentation Team for visual displays, graphs, wordcharts and other business graphics. Installation took some time, but once loaded it all worked - though much more slowly.

Clearly a lot of screen processing was taking place between Gem and the emulator and the result was a program that would not really be a practical proposition on the Arc. However, it all worked and no crashes were experienced.

In particular I was impressed with the way the emulator controlled the mouse. It acted like a normal Microsoft mouse until you pressed the Menu button, whereupon it reverted to an Arc mouse so that the PC window would be re-scaled, Arc packages accessed and so on.

Another click on the Menu button to select the option *Connect mouse* and you were back with a Microsoft mouse - very clever.

Surely the ultimate test of an emulator must be a full-blown DTP package, namely Ventura version 2. Even though the manual proclaimed that this had been tested and found to be working, it was difficult to believe.

The complete system was installed, loaded - and it ran perfectly. Surprisingly it was faster than the Presentation Team, even though it, too, was being run in the Gem environment. I noticed a slight prob-

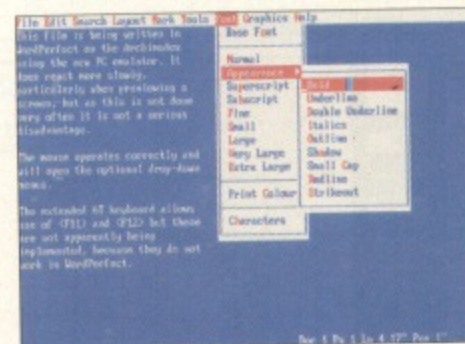

WordPerfect 5.1

lem printing to an Epson laser printer in HP Laserjet emulation in that the printed page had shifted slightly, but this may well have been due to a incorrect setting of the printing margins.

Here was an interesting scenario: In reality an Arc printing to an Epson, but for me it was a PC printing to an HP Laserjet.

The PC window was reduced to occupy half of the screen, and then Impression 2 loaded into the other half. Now by merely clicking on the mouse I could swap between the king of PC DTP and the king of Arc DTP.

Even after swapping and editing constantly between the two, the emulator never got confused and I could not force an error message.

Also supplied with the emulator is the MultiFS application for swapping files between Risc OS and DOS. It cannot be run while the emulator is active to avoid possible clashes by two applications attempting to write to the hard disc.

Double clicking on this application will create new disc icons on the menu bar and from then on, directory maintenance is very similar to Risc OS for copying, deleting and moving files between the two formats. Dos discs can be formatted, including the system option to make the floppy discs bootable.

### Summing up

This emulator is superb. I did not believe that any software could be written to make Dos programs so accessible on the Arc. It must be galling to *downgrade* some of the Arc's best features to cope with the idiosyncrasies of Dos, but it has been achieved with tremendous success.

It would not go wrong, the speed of most programs was quite acceptable and the ability to transfer data between the two systems made it a pleasure to use.

This review was originally prepared in WordPerfect on a PC, and transferred to WordPerfect on the Arc for editing. It was then saved as a generic file and loaded into Impression to see how it looked with the illustrations.

Finally just for good measure, it was saved as a text file and transferred back into WordPerfect for last-minute corrections.

It is now very difficult to justify owning a PC as well as an Arc, and this emulator could well help the Arc to become accepted more widely in the business world.



# junior's database

## ...child's play in a grown up world!



Junior Database has been designed to meet the specific needs of the National Curriculum and is destined to become a class favourite with teachers as well as children of all ages.

Junior Database comes with an interactive Hotlinked Tutor (*the first of its kind*). There's no longer any need for a lengthy or offputting manual, Hotlinked Tutor is your onboard personal expert, on hand to advise, correct and guide you through the fascinating world of data, helping to create colourful graphs that will bring your facts and figures to life. One day all applications will be written this way...

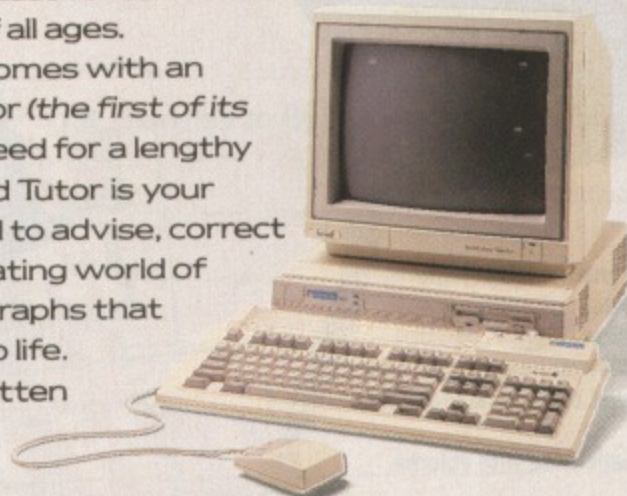

RRP £53.00 (Education £39.95) excl. VAT  

Available from: IOTA Software Limited

The St John's Innovation Centre, Cowley Road, CAMBRIDGE, CB4 4WS.

Tel: (0223) 421542 Fax: (0223) 421543

## ALTERNATIVE ONE

Instead of three free issues you can choose this special money-saving offer:



... it's the **ULTIMATE** experience!

The Soviet Union has produced the finest fighter in the world. Now Domark give you the thrill of flying the formidable MiG-29 Fulcrum on your Archimedes. Prove your skills in a series of gruelling missions based on real life scenarios!

It offers:

- ★ Ergonomically optimised controls
- ★ Actual instruments and avionics
- ★ Accurate modelling of high g-effects on pilot, including simulated blackouts
- ★ "Expert-driven" combat systems
- ★ Unique missions featuring real world scenarios

Included in each pack is a superb 128 page full colour manual, full instructions, and a giant poster.



Archimedes/A3000 only

RRP £39.99

But take out a subscription and get it for...

**£19.99**

## ALTERNATIVE TWO

Instead of three free issues you can choose this special money-saving offer:

### PERSONAL SOUND SYSTEM

Now you can lose yourself in a new dimension. Experience all the fun and excitement of your favourite games, music packages, etc. without disturbing the rest of the household.



#### SYSTEM COMPRISES:

- ★ A cleverly designed interface and the latest high-velocity lightweight headphones
- ★ Crystal clear sound reproduction
- ★ Can be used in three different ways: headphones sound only, monitor sound only, sound on both headphones and monitor
- ★ Interface features a tough plastic case with volume control
- ★ You can also use the headphones with your personal stereo
- ★ Full instructions supplied to help you get the most out of this superb accessory

Exclusive to The Micro User and available ONLY to subscribers for

**£5**

# Three months' FREE reading...

## (PLUS 15 FREE DISCS OR TAPES)

### ...when you take out an annual subscription

# FREE!





**Has upgrading  
your BBC Micro given you  
hardware you no longer need? Or have  
changing interests left you with unwanted software?**

# MICRO USER CLASSIFIEDS

- Electron Accessories. Data recorder, ADFS 3.5 Pres disc drive, plus1 interface, plus3 disc drive interface with tape to disc ROM chip. Over 100 games and numerous magazines £120 Tel: 0246 270748.
- BBC Master 512k, Diskdrive, Teletex adaptor, Software, £450, Brentwood, 210031.
- BBC "B", Hi-res colour monitor dual 40/80T D/Disc drive, printer, recorder, mouse, music 500, 9 ROMS software worth £1000. Includes leads, magazines. Tel: 0344 481789.
- PRINTER-Mannesmann Tally MT\* & 80-colour, 9-pin, business printer. 200cps draft, 50cps NLQ, 7k buffer, very reliable, very good condition, with ribbons, 2 manuals, and 2 font cartridges. Worth £520 new a bargain at £150ono. Tel: Bristol (0272) 324608.
- MASTER 512 Upgraded to 1 MB.FAST-BOOT, CUMANA 40/80, 3.5/5.25 D/S.D/D, STAR LC10 Colour Printer, Morley Teletex, Phillips Mono monitor, GEM & AMX SuperArt & Mice, Tape Recorder, Joystick, Safe Cartridges & ROMS, Lots of software. £800 ono. Tel: 047474387.
- Master 128, Dual double sided 40/80 5.25" disk drive, dump ROM, software, Fleet Street editor, mini office II elite paintbox II. Little used £325 Tel: Preston (0772) 733140.
- PC Emulator. Hardly used. Full documentation £50 (283) 733160 Evenings.
- BBC B Issue 7, DFS D/Drive, wordwise+, wordaid spellmaster3, books, £285 also 2nd processor £70 Nightingale modem £50 solidisk DFDC + ADFS ROMS £35 + many others offers? Tel: 0225 859881.
- BBC B Issue 7, ATPL sideways board, 1770 DFS, Acorn speech cassette recorder £135 Tel:0705-263632.
- BBC B, Double 5.25" Drive, Printer + paper, ribbons, AMX mouse, books and (ROM) software. VGC £300. Basildon 0268 526280.
- RISC-OS Reference Manuals complete £65; music-500 no data/software £20; ARC-PCB £100; A3000 technical manual £20; ALPS £15; DAVE 0267-236499.
- FREE MODEM! with A3000, Colour monitor (and stand) serial upgrade, manuals and software. V.G.C. sale due to upgrade. All for £700. Tel:(0533) 864910.
- BBC MODEL B with disc interface cumana CS400 400k 80/40DS with PSU PHILIPS 7502 High-Res Green 12" monitor datascribe software, £200 ono Phone (0532) 578543.

- MODEL B issue 4 8271 DFS, excellent condition £180 Tel: 081 805 4851.
- BBC B Issue 7 OS1.2 DNFS, 40/80T, drive, cassette, 16k swr, ROMS, software on disk and tape. 3yrs Micro User in binders £250 Tel 081-397-1737.
- Master 128, Dual DS80T Drives, 40TSS Drive, Demon modem, vine overlay ROM board, uviprom 16/32k programmers, interword, Epson LX80, pvendana dwp1120 daisywheel, cartridges, many books £450 for quick sale may split. Bradford 0274-610045.
- Archimedes 1st Word Plus Release 2 £56 Sevenoaks 0732 454707.
- BBC B issue 7, 40T drive, 40k Sideways RAM, ROMS software (worth £400) magazines, books, £195. Tel:0522 685295.
- Master 128., Watford bridge unit 5.25 & 3.5 D.D.,BBC colour monitor, manuals, not boxed, many programs £500 Phone Foster 0244 390184.
- Epson RX80 Printer £60 Interword £25 Master ROM £12 ADTvolkit £10 Printmaster £8 Superart, pagemaker, mouse (Master) £30 0475 38502.
- BBC B View ROM, Dumpout3 ROM, joystick, tape recorder. Many games, MINI OFFICE, books. Hardly used. £125 Phone after 5 081 942-5002.
- Archimedes: Dabs ABC Compiler £40-00, Minerva GammaPlot £27-50, Minerva System DeltaPlus £27-50, Acornsoft Twin £10-00, Wordwise Plus £10-00, InterDicator 2 £12-00, Voltmace Delta-cat joystick £12-00. All as new. 0782 771914 after 8.00pm weekdays.
- Master 128, Microvitec Colour monitor, Twin 40/80T Drives, Plinth, All manuals, Master ROM Interword Plus Educational software £395. 081-4210325.
- BBC B, Watford 40/80 DS Disc Drive, Twin voltmace Joystick £220 ono. 021 559 2786.
- Wanted for BBC B, Aviator, Flight Simulator and other 5.25 Disc based games 071 352-3103.
- Watford scanner (BBC), Wapping Editor,(fonts/clipart), Trivial Pursuit, AMX Art+Max. All little used, Half Price, TEL: Southend 612793.
- BBC B Issue 7 Acorn 1770 DFS + Watford DDFS Also BBC B Issue 4 Solidisk DDFS with Switchable 8271/8770 controller and solidisk 128k RAM. £200 Phone 0238 541580.
- Master 128k, Watford 5.25" 40/80 Drive Inc. P.S.U.,£299. 081 5581592.

- BBC B+ 64k, 40T Disc Drive Plus software £200 ono TEL:07687-78250
- BEEB Video Digitiser as New £80 o.n.o. Cumana Touch Pad £30. Both with software. TEL: (0323) 898039.
- BBC B Issue 7 Watford DDFS £150, Interword £25, Watford ROM/RAM 64k £30, Watford Shadow RAM £30, SS 40T 5.25 in. Drive £20 the lot for £200 ono Amersham (0494) 721234. Ask for Jon.
- BBC Model B 1.2 OS Issue 7 Watford 1.43 DDFS 40/80 Track DD DS Drive microvitec colour monitor Pace Nightingale modem. Vigen cartridge socket and sockets. Cables Books and software £400 ono. 0543 676628 After 6:30pm.
- BBC-B Diskdrive software Teletext System £190-00. BBC-B Diskdrive software keyboard Synthesiser £190-00. BBC Master software 2 Drives monitor £250-00. Amstrad PPC512 I.B.M. portable £180-00. Olivetti PC1 Monitor IBM Clone £165-00. Phone John 0895 631184.
- Wanted an advanced Plus 1 and Plus 3, any other ad-ons for Electron welcomed. Please ring 0869 40488 after 7.30pm.
- BBC B, Disc drive, extras £250 ono 081 840 7853.
- A3000 Learning curve Acorn colour monitor Impression II and games £975 o.n.o 0621 893064 (Essex).
- Archimedes 300 Series Motherboard. No O.S. or RAM chips. Otherwise complete. £250. Also ARC P.S.U unused £50. 0463 83214.
- BBC Master compact, Disc Drive, Welcome Disc, AMX Super Art and mouse, 31 games includes some educational, 9 Micro User discs, Manuals £275 Stafford 56299.
- Master 128, Twin 40/80 Drives, Colour Monitor, Manuals and Citizen 24 Pin Printer. All V.Good Condition. £350. Telephone 0257 426789. (N.W. England).
- Wanted!! to buy/borrow Mach Technologys Modula-2 as copyright has ended. Phone Mark 0226 282501
- BBC Z80 2nd processor C/W software plus CP/M wordstar. £250 ono. 0480 218391
- Master Compact + over £100 software including word processors, Database, spreadsheet, stock control etc. V.G.C. £300 ono Tel: Mark 0342 810943 (Evenings)
- BBC B 32k W.E. ROM Expansion. Cumana DD. Microvitec. Epson FX80. Perfect. Much S/W + games offers to Keith 081 9534584

**This is THE place to  
advertise your surplus  
items.  
Our 105,000 readers  
are always on the  
lookout for a bargain  
and this is the first  
place they'll look!**

- For Sale: For the BBC B computer W.E. solderless ROM board £25.00. W.E. 32k shadow RAM card £35.00. AMX design package £35.00. AMX stop press package £45.00. Uncased disc drive £60.00. Phone 081 5693214 Eves.
- Master 512, Problem solver, Dual drives, Dumpout 3, joysticks, reference manuals, business software, many manuals, games, excellent condition, £495 ono. Tel.: 0992 469632.
- Cheapest Archimedes PD library around. Send 50p + Floppy + envelope to Equinox, 27 Station Road, Earls Barton, Northampton, NN6 ONT.
- BBC Master compact, colour monitor, disc drive, software, worth £750, accept £375. Tel: (0256) 762972.
- 512 Co-processor board £100. Cub monitor £75. Matrix printer £50. laser printer £250. Tel: 0206 564184 ask for flat 15.
- Master compact, 3.5" drive, colour monitor £210 software, welcome guide, joystick. £430 ono.Tel: 081 4604735 evenings.
- BBC B, 32k issue 4, music 500(D), 4000, faulty twin drives, vigen computer case, hundreds of discs, books, tapes. Modem/ROM board, ROMS, speech chips, leads, plus spectrum with music cartridge. Tel: (0869) 47204. £400. Buyer collects (Oxfordshire).
- Master 512 second processor £100. Second processor unit £50. DS 40/80 disc drive £30. Tel.: 0462 730988.
- BBC B ADFS 64k sideways Cumana 40/80 twin drives cub, microvitec colour monitor, all books manuals and some software £295 ono Tel: 0704 73435.

PLEASE PRINT THIS AD IN THE NEXT AVAILABLE ISSUE OF THE MICRO USER

Name \_\_\_\_\_  
Address \_\_\_\_\_  
\_\_\_\_\_

Cheque enclosed for £ \_\_\_\_\_  
(minimum £2 for 10 words)

I certify that any software offered for sale is original and not a copy

Signed \_\_\_\_\_

Daytime Tel: \_\_\_\_\_

POST TO: Micro User Classifieds, Europa House, Adlington Park, Adlington, Macclesfield SK10 4NP

### CONDITIONS

- This service is EXCLUSIVELY for the use of private readers. No trade ads will be allowed.
- To avoid encouraging software piracy, all ads will be carefully vetted before they are accepted.
- Ads can only be accepted on the form opposite (or a photocopy of it).
- There is no maximum to the number of words you include in your ad. if there is insufficient room on the form, continue on a separate sheet of paper.
- The cost is 20p per word, with a minimum of 10 words.
- **WE GUARANTEE your ad will appear in the next available issue of The Micro User.**



## Heads and tails

LOOKING through some old *Electron User* magazines I noticed that in the March 1990 issue J. Darlington wanted to convert the Header program on the monthly cassette to disc.

In June, Joan Barnard showed us how to do this, but only if PAGE was set to E00. This was nearly a year ago, but as these are Electron programs on side 2 of the monthly tape with the Header program here is how you do it if PAGE isn't set to E00:

```
*LOAD HEADER 2000
*SAVE HEADER 2000 +XXXX E00
E00
```

The XXXX is the address to put it so the program has finished loading you type the second four digits after the first lot - HEADER OA 0AD4

# PRIZE letter

Then set up the !BOOT file as:

```
*BUILD !BOOT
0000 PAGE=&E00
0010 CHAIN"HEADER"
0020 Escape
```

Again XXXX is where to finish saving at ans is used as above. - Adam Chapman, Kirkcudbrightshire, Scotland.

● Thanks for the tip. However, from this month subscribers of the Electron and BBC tape as well as the 8 bit disc versions will find a new machine code header program that loads much faster than before.

## Coping with virus mania

RECENTLY there has been a lot of news about viruses on the Archimedes. I have noticed that many people are worried about the subject, probably because it can be quite confusing.

I think that people should take heart from the fact that so far only one virus has become widespread and The Micro User was able to put a program to remedy it on its monthly disc with such speed.

If, however, the Archimedes community is to avoid the mass virus hysteria in evidence on the PC and Amiga machines, people must be careful about

what information they publish. For example, a catalogue from one PD library contains the advice that to avoid problems with viruses users should "regularly reset the machine with the delete key pressed".

If they think that a virus can hide in the battery-backed ram, they shouldn't lecture the public upon virus precautions. I prefer to keep my machine's configuration the way I like it. Leaving your floppy discs with the write-protect tab open is probably the safest way of guarding from viruses. - A. H. Bain, Oxford.

● The whole area of computer viruses is strewn with ignorance, from the idiots who think it is clever to write them,

to a certain major UK main-frame computer manufacturer who sent in security guards with rubber gloves to remove a disc containing a virus from the building.

But the biggest danger is from individuals who never make backups and think that viruses only happen to other people.

So far viruses have been merely irritating, but they are starting to become fatal. I will not add to the questionable ego of the character who wrote the latest virus by naming it, but he is a pretty naff programmer and the new version of VKiller on this month's monthly disc will deal with it.

Don't be paranoid, but do be sensible and have a virus checker. Check new discs before using them and if you have a hard disc install your virus checker so that it runs continuously in your machine right from switch on.

## Finding the right time to buy

I USE an A3000 at school and am saving up for an A400. However, there are some points I am unsure about.

I have heard that a version 3 of Risc OS is to come out soon which will be more multi-tasking. Will this mean that in true 8 bit BBC Micro fashion that I won't be able to run version 2 programs like the different versions of Basic on the BBC Micros and that the Programmers Reference manual will have to be rewritten?

Also I've come across Archimedes' with their system sprites - like the Task Manager and error warning icons - redefined. Do you know how this is done? At

present it seems that a lot of application software and hardware being made available for the Archimedes uses the podules.

The A400 series has four slots, so what do you do if you want a Pineapple Realtime Colour Digitiser. These are advertised as double width, does this mean they take two slots - plus a direct drive printer, sound sampler, SCSI interface and a Scan-light?

An expansion system is one feasible idea, but it would make the Archimedes messy and Acorn has tried hard to avoid after their experience with the BBC Micro's spaghetti wiring.

Finally are you going to be covering how fonts are created on the Archimedes? I would very much like to design some of my own outline fonts and it can't be impossible as EFF have managed it. - Ian Kershaw, Poynton, Cheshire.

● Firstly, if you wait for new software or hardware to come out before buying a computer you'll never get one. Software is continually being upgraded and improved, and luckily on

WANT to write to The Micro User? The address is:

Letters; The Micro User, Europa House, Adlington Park, Macclesfield SK10 4Np.

Writers of the most interesting letters will receive a £10 prize.

the Archimedes all the companies, including Acorn, are making new versions downward compatible.

The only area of incompatibility will be with software that breaks the rules.

To redefine system sprites first you need to know the names of the ones you want to replace then create a paint file with the new design but keeping the same names. Save this on disc and then issue the command:

IconSprites

and your sprites will take the place of the standard ones,

Podules or expansion slots are a curious case, since the hardware allows you four, but the Archimedes internal software will happily handle more

## How to cheat in Elite on an Electron

I RECENTLY bought The Micro User for the first time and saw the Elite cheat. This is in Mode 7, but does it matter that I have an Electron which doesn't have Mode 7?

Also I've been trying to get in touch with a company called Slogger. Can you help? - Peter Taphouse, Oxford.

● Whether or not you have Mode 7 doesn't matter, although there may be some funny shapes on screen instead of colours. You can contact Slogger by writing to: Slogger, St Just, Penzance, Cornwall TR19 7RZ Tel: 0736 787 272



— a similar situation to the BBC Micro with its rom slots.

As a double width socket does require two slots you'll soon find yourself out of room. An expansion box system seem to be the only solution.

Font creation — especially when dealing with outline fonts — is very complex and involves a lot more than just using the software to create new character designs.

To look good a new font must also stick to rules concerning sizing and similarity between different characters. We don't have any plans to cover this in the near future.

## Making your mark

COULD you please explain for me which key to use on my BBC B to produce a l.

I have been trying to type in a program from the January issue and the usual apostrophe — Shift+7 — doesn't produce the required result. — R. Hudson, Woodville South.

● We do still have the occasional problem with character translation between machines. In this case just type in a £ in its place.

## Buyer's guide to the A3000

I'M about to buy a BBC A3000 but I have some questions I'd like answered before I part with any money:

What is the Learning Curve Pack? What is Risc OS? Is it easy to write, save and load Basic programs? Will the BBC A3000 work with a

colour TV? Will games for the PC such as Battlechess, Sopwith and Indiana Jones work on it? Will I need any hidden extras?

Can you advise me? — Matthew Hall, Cirencester, Gloucester.

● The Learning Curve is a pack containing a BBC A3000 plus a video to help you set up, a copy of Genesis, a hypertext system very popular in schools, as well as the First Word Plus wordprocessor, plus manuals, applications discs and a magazine to guide you through.

You also get a PC emulator. The original one in the pack was DR Dos, but ask your dealer about upgrading to the new PC emulator which is considerably faster as well as having more features such as allowing you to use the mouse.

If you want to run PC games software you will have to check that it will run on a EGA screen — all PCs have different amounts of IBM PC compatibility.

Although the A3000 has a standard 1Mb of memory, most of the bigger dealers will give you a free upgrade to 2Mb which actually triples the memory available to you.

Risc OS is the operating system unique to the Archimedes and allows you to multi-task — have more than one application running at the same time.

By pressing function key 12 you can get into Basic and a BBC Micro emulation is available so you have access your 8 bit programs, but loading and saving programs is much easier.

You can have your A3000 working from a TV rather than from a monitor, but you'll have to buy a modulator to allow you to do this — most major

dealers stock these.

What you buy after that is really down to what you want to do with your machine.

## The gentle art of table rapping

I AM a newcomer to A3000 computing, having been fortunate in winning your eighth birthday competition. After using the Electron for several years I am amazed at the sound and graphics.

I do however have a few problems. I have noticed that the Acorn monitor screen sometimes gets darker and then becomes brighter again when I knock the table. Is the monitor at fault?

I am also having problems copying files between discs and transferring my old View files to First Word Plus. While the IPaint program

hangs up occasionally with the message: Paint has suffered a fatal internal error (type=5) and must exit immediately.

Finally, I've seen an advert in the The Micro User for Wonderland. Is this the same game as on the PC? — Paul Van Reenen, Bournemouth, Dorset.

● Congratulations again on winning the competition. The monitor problem sounds like a connection problem than anything else. Check to see if both plugs are securely attached, and if this is not the cause check the leads themselves.

Paint and Draw are excellent programs, but both come up with this problem from time to time as neither is totally bug free. The only solution is to save your work often.

To copy files across click on the disc icon, leave the window as it appears on the DeskTop and replace the disc with the one you want to copy to. Open this disc too.

Then pick up the file/folder/sprite whatever and drag them to the new disc window. You'll be prompted when you have to change discs.

To transfer View files to the Archimedes is simple.

Just save your files using the WRITE command and access them in the normal way on the Archimedes.

Unfortunately, reading them on First Word Plus is not as easy as it is using Impression or Ovation, as you will have to spend some time putting the text into order.

## Restoring an aged Acorn

LAST year I acquired an old and non-functional Acorn Atom from a friend, as I like to collect and restore old computers and give a home to these forlorn and broken micros that usually crawl off to die in some dark corner.

Following a complete strip down and clean, plus a new 6522 chip, the Atom now seems to be operational. But it's bored with my humble efforts at programming and has developing an inferiority complex sat next to my supercharged 32k Model B.

Hungry for software, I've fed it Bug-Bytes, Chess and Galaxian to fend off it's impending nervous — or is it bussous — breakdown. Indeed it seems to be getting quite listless demanding I use the on-board assembler.

I am at the end of my tether, as I am unable to find any software or upgrades to amuse it. If anyone would like to help me to restore this poor machine's self-esteem and sense of purpose with old software, books, spares or upgrades moping quietly beneath their beds, please get in touch with me.

A friend has told me that he vaguely remembers a rom that gave a degree of compatibility with BBC Basic and I'd also like to get hold of a circuit diagram and official power supply as I'm struggling with an overheating Spectrum supply. — M.J. Wilkins, Cardiff.

● We're glad to hear that the Atom has found a good and appreciative home. If you can help this computer complete it's rebirth contact Mr Wilkins on (0222) 627411.

All programs printed in this magazine are exact reproductions of listings taken from running programs which have been thoroughly tested.

However, on the rare occasions when mistakes occur, corrections are published as a matter of urgency. Should you encounter error messages when you type in a program, they will almost certainly be the result of your own typing mistakes.

Unfortunately we cannot answer personal programming queries concerning these mistakes. Of course letters about suggested errors will be investigated without delay, but any replies found necessary will only appear in the letters pages.

## SAVE MONEY AND THE ENVIRONMENT

In 1989 Western Europeans threw away over **128 million** printer ribbons. They weighed over **9,000 tonnes** in total and would reach **right around the world** if laid end to end. A used ribbon cartridge is being thrown away somewhere in the UK **every second** of every day.

You can help put an end to this environmental waste and save some money at the same time thanks to **RE-INK**, a revolutionary new spray which brings new life to exhausted fabric printer ribbons.

**RE-INK** is cost effective and simple to use. Simply open up your plastic ribbon cartridge, spray a few squirts of **RE-INK's** special ink and lubricant formula and your ribbon is good as new – sometimes even better!



BEST OF ALL, **RE-INK** IS

AVAILABLE IN THIS SPECIAL  
READER OFFER FOR ONLY

**£12.95**

- ★ **RE-INK** will save up to **90%** on what you currently spend on new ribbons
- ★ **RE-INK** – treated ribbons give **clearer, blacker** print than new ribbons
- ★ **RE-INK** is a very **high quality ink** – no blotchy or patchy ink
- ★ **RE-INK** is universal – it works with **all** fabric ribbons
- ★ **RE-INK** can extend the life of your printer with its special **lubricant oils**

Order using the form on Page 112

**NEW**

## SAFE CYCLING FOR THE WHOLE FAMILY



Cycling is a pleasant, healthy, carefree sport enjoyed by millions from all age groups. However, crowded roads can bring unforeseen danger – so for you and your family's protection we have the very best in cycling helmets. (All our headgear conforms to British Standard BS 6863.)

● The OGK Forza hat, for adults, is a remarkably lightweight and yet fashionable hat which remains comfortable despite conforming to the strictest safety standards. Normally £38.95, this superb hat (in white only) is available for just **£29.95**.

● For children, we have the Britax Integra for two age groups – 4 to 8 years old and 7 to 14. Britax are the UK's leading child safety product manufacturers.

As with the adult helmet, it is lightweight and comfortable and at only **£29.95** (RRP £34.95), represents exceptional value. This helmet is only available in blue.

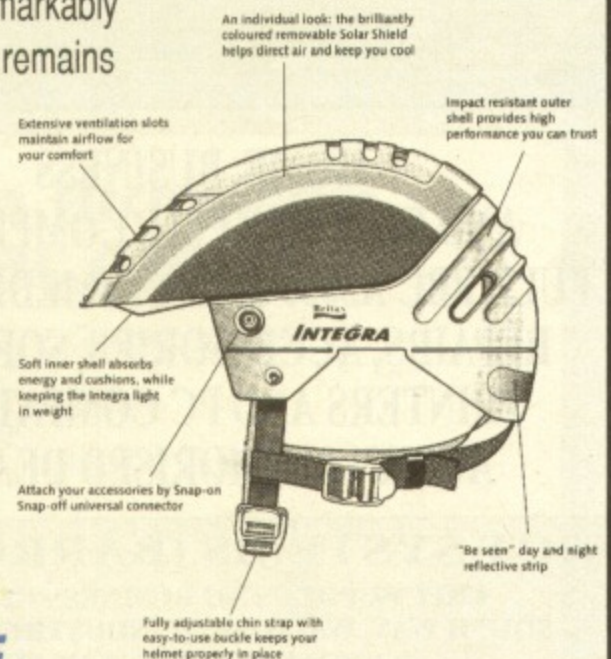

For further details phone **051-357 1275** or write to:  
**Cycling Offer, Freepost, Ellesmere Port, South Wirral, L65 3EB**

Colour coded sizing pads tailor your Integra to be a perfect fit

# The Micro User gui

## ESSEX

### Le Computer

the Essex Acorn Specialists

- Home and School
- Special needs
- Specialist Software

Tel: (0245) 362225

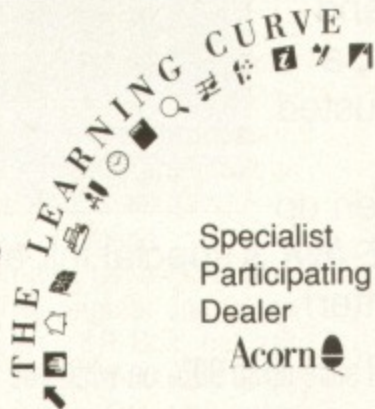

## LONDON

### ACORN APPROVED LONDON DEALER

Wide range of software and hardware stocked

EDUCATION ORDERS WELCOME

PHONE FOR BEST PRICES

Easy to get to  
Train: WOOD ST Station  
(British Rail)  
Road: Bottom of M11,  
just off North Circular  
Tel No: 081-521 1784

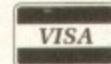

AUTOMATIC SERVICES  
217 WOOD STREET  
WALTHAMSTOW  
LONDON E17 3NT

## ESSEX/HERTFORDSHIRE

### The Complete Service

ACORN & IBM PC compatibles, printers and software. Full training in word processing, desktop publishing and programming. New, correspondence courses available.

FREE training included with all computer sales.

We also repair computers, monitors and printers



High Street  
Hatfield Broad Oak  
Near Bishops Stortford  
CM22 7HE  
Phone: 0279 718767  
Fax: 0279 718596

## CUMBRIA

### FREE support with all our systems

- \*Expert advice! on system purchase
- \*Expert help! on using your system
- \*Expert backup! software support and hardware servicing
- \*Leasing facilities now available

Consult the experts!

### CSS Computer Centre

Unit 3A Townfoot Ind. Est. BRAMPTON  
CUMBRIA CA8 1SW  
☎ 06977 3779

Acorn Qualified dealers and Unix centre  
Authorised SJ Networks, installer \* Education specialists  
Government plc and education orders welcome



Acorn  
The choice of experience.



## HAMPSHIRE

HOME, BUSINESS  
AND EDUCATIONAL COMPUTERS  
FULL BBC A3000 & ARCHIMEDES RANGE  
REPAIRS, ACCESSORIES, SOFTWARE  
PRINTERS AND PC COMPATIBLES  
ACORN AUTHORISED DEALER

### FACT SYSTEMS (BARROW) LTD

UNIT 19, FOCUS 303 BUSINESS CENTRE,  
SOUTH WAY, WALWORTH INDUSTRIAL ESTATE,  
ANDOVER, HANTS, SP10 5NY

10AM-5PM MON-SAT

(0264) 334811

REAR OF LOCOMOTORS

## LONDON

### PRINTER REPAIRS

specialists in laser printers

EPSON, STAR, SEIKOSHA,

HP, BROTHER, CANON

Sales/Service/Support/Spares

For Government and Educational organisations we can repair printers at a fixed rate. Please ring for further details

B.V. Computer Maintenance Ltd

Park Royal Business Centre,  
9-17 Park Royal Road, London NW10 7LQ

Tel: 081-965 4056

Fax: 081-961 7313

Contact Yvonne Benson on 0625 859555 now

# de to local dealers

## MIDDLESEX

### JR Letronics Co

- Archimedes/A3000/BBC
- Computer Peripherals
- Educational & Business Software
- Documentation
- Discs & Paper

☎ 081-977 8053  
and Fax

The Annexe, 2 Broad Street, Teddington, Middlesex TW11 8RF  
After sales helpline - We try to help  
Open: 10am-5pm Mon-Sat



Proprietor:  
J. H. JARLETT



The choice of experience  
Authorised Dealer

## CLEVELAND

### YARM COMPUTERS

HARDWARE - SOFTWARE - PERIPHERALS  
SUPPLIES TO EDUCATION, BUSINESS AND HOME

TEL: 0642 786922  
FAX: 0642 783740

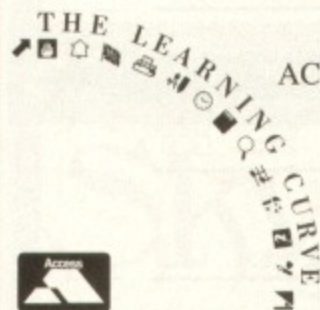

ACORN DEALERS



WINPENNY HOUSE, 137 HIGH STREET  
YARM, CLEVELAND TS15 9AY

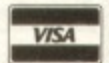

## GLOUCESTERSHIRE

### AJL ELECTRONICS BBC/MASTER/ARCHIMEDES SPECIALIST

FULL RANGE OF SHERSTON EDUCATIONAL SOFTWARE IN STOCK -  
BBC/ARCHIMEDES S.A.E. FOR CATALOGUE  
MICROVITEC TO ARCHIMEDES MONITOR CONVERSION £30 + VAT  
(Retains contrast control!)

Fast repair service on Acorn equipment

Telephone: (0452) 311031  
Fax: (0452) 309125

24 HR ANSWER SERVICE

49 CALTON ROAD, GLOUCESTER GL1 5DZ

Specialists also in high performance satellite television systems  
Members of The Confederation of Aerial Industries



## ISLE OF WIGHT



### COMPUTER TUTORIAL SERVICES

#### ACORN DEALERS

Archimedes &  
A3000  
All Hardware and  
Software

Sales & Business Consultancy  
Individual Tuition  
Bespoke Software  
Micro Computer Supplies

TEL: (0983) 294333 FAX: 298439

4 Mill Hill Road, Cowes, Isle of Wight PO31 7EA

## KENT

### COMPUTEREYES

16 Starnes Court, Union Street, Maidstone, Kent

Archimedes specialist for  
the Kent area



☎ (0622) 751096



## DERBYSHIRE

### Acorn Archimedes BBC A3000

Sound Advice

Sales

We offer

Home Tuition

Technical Support

Acorn Approved

SELECTIVE  
COMPUTER  
SERVICES

Telephone  
Derby (0332) 690691

to have YOUR company included in this section





EQUIPMENT ALWAYS IN STOCK

Simply the Best!

**MICROMANIA UK**  
SPECIALISTS IN QUALITY 2ND USER EQUIPMENT (0332) 830178

EVERYTHING SERVICED PRIOR TO DESPATCH  
Cheaper than all the rest!

SALES HOTLINE: (0332) 830178

MAIL CHEQUES TO: MICROMANIA 9 GLAMIS CLOSE OAKWOOD DERBY DE2 2QJ

Carriage Extra

ALL EQUIPMENT 3 MONTHS WARRANTY

Archimedes A3000 Base.....£495  
Archimedes A310 Mono .....£645  
Archimedes A310 Colour .....£695  
Archimedes A410 Base.....£895  
BBC Master 128K/Drive/Monitor..£320  
BBC B/Drive/Monitor.....£245  
Microvitec Colour Monitors From ..£130  
Philips Colour Monitors From.....£150  
Philips Green Screen From .....£45

**BARGAIN BOX!**  
1 Meg Upgrades for A3000 £50  
BBC 5 1/4 40T Drives Cased/Leads £75

REPAIRS REPAIRS REPAIRS  
ACORN REPAIR SPECIALIST WE'LL BEAT ANY OFFICIAL QUOTE. 3 DAY TURNAROUND

EDUCATIONAL AND INSTITUTIONAL ORDERS WELCOME

A310 UPGRADE TO 2 MEG £230 IN STOCK

PART EXCHANGE WELCOME

**ARCAYNIA** The Archimedes Public Domain

**Arcaynia Demo Disc 6 and July/August Catalogue Booklet Package**

Our Demo disc consists of some of the latest and best offerings in the PD world, as well as some software exclusive to us, including the stunning Arcaynia Arm code demo. This comes with the new July/August edition of our catalogue, a professional 12 page printed booklet detailing all of our range, for you to browse at leisure. Our range consists of 350 quality discs all available from under £1.30 each.

Orders are often processed the same day, but all orders are processed within 3 days, Guaranteed.

Send a £1 coin now, to receive the package.

**Arcaynia : PO Box 1927 : Sutton Coldfield : B74 3QZ**

**Family History** BBC/Master £21.76 inc.  
Archimedes £26.77 inc.

**Software for MS-DOS & BBC/Acorn Machines**

**Micro-Aid Kildonan Courtyard, Barrhill, GIRVAN, Ayrshire, KA26 OPS**

Tel: 0465-82288 FAX available VISA/ACCESS

**Archimedes Public Domain**

**Skyfall** VISA ACCESS

Just £1 for the **DOUBLE PD Demo Disc**  
With over 2 1/2 MB of Sample Software.

Send for Skyfall's Summer Catalogue, it contains full details of our 360 disc range. We offer a support hotline, which can accept credit card orders, plus rapid despatch on all orders.

Please send £1 to:  
PO Box 2220, Birmingham, B43 5RZ.

**SEA**  
W  
I  
N

**SIGNWRITER**  
for the BBC & Archimedes

Professional lettering that looks good at larger sizes. Produce quality Banners, Posters, Letterheads, Adverts, Signs, Tickets & Notices in minutes.

BBC Disk £29.95 - Archimedes £39.95  
Extra Fonts at £5.75

Black & Coloured Ribbons - red, green, blue, purple, orange & brown for various printers. Please ring for availability and prices.  
5 1/4" Discs £0.40 each. 3 1/2" Discs £0.80 each.  
(All prices include VAT and Delivery)

We take Access and Visa. Please make all cheques payable to WIGHT SCIENTIFIC

WIGHT SCIENTIFIC  
44, ROAN STREET, GREENWICH, LONDON SE10 5JT  
Telephone: 081 859 2899 Fax: 081 853 4416

DataKing - "...the database package that schools - and most people - actually want" - Micro User

Available now: **DataKing Plus**

- \* Fully RISC-compliant
- \* Wide range of graphs and charts
- \* All charts export to !Draw
- \* Designed (by teachers) to meet National Curriculum data handling requirements
- \* Simple to operate - learn and use in one lesson
- \* Rapid file creation and data entry
- \* Comprehensive search and sort; define fields as function of other fields, "fast data" (tokenised fields), label printing, statistics etc
- \* Perfect for non-IT specialists
- \* Ideal for classroom and home use
- \* £59 inc. - inclusive of site licence
- \* LEA licences - £10 per school

Shenley Software, 5 Coombefield Close, New Malden, Surrey KT3 5QF 081-949-3235

**THE DATASTREAM**

The DataStream is pleased to announce a price cut. We can now offer our 450+ PD discs from just 99p. Many of our discs are exclusive to the DataStream. We also offer many other customer services such as scanning, digitizing, laser-printing and technical assistance. All orders are sent out within 2 days of receiving them, by 1st class post. No wonder we are the official PD house of Club A3000.

The newest and most exciting disc-based magazine, **Absolutely**, has just been launched. Every month it features 2 discs of the latest, compressed PD and articles on topics such as ARM coding and demo writing. Why not send £1 for our DataStream Information Pack, which includes a 40 page catalogue giving details of all offers, a demo disc containing some great PD and the amazing DataDemo3.

**32 HOLLINWELL AVENUE, WOLLATON, NOTTINGHAM, NG8 1JZ**

**InData** Next advert around August 92 Tel: (0752) 781286 **InData**

**Why not publish your Database or Multi-media Files?**  
Now available; "Arc Power Disc" an STracker Utilities Disc £1.00  
And 13 PD Outline Fonts for £2.00 Postal orders; payable to D. Heath

**Submitting Database Files;** Say how many fields, their names and Lengths, the database it's for, you can send them as a CSV, TAB or in their database format. **Multimedia Files;** Please supply it with the browser. **Up to 30% of the sale price in royalties.**

**Sorry no files yet!**

26, Luxmore Close, Leigham, Plymouth, Devon, PL6 8NX.  
**Wanted tools for making Demo's**



## BANK MANAGER

Complete and versatile personal accounts program. Consistently acclaimed!

*'data entry is a delight...professional...excellent product' Micro User April 86*

**Standard version:** Enter cheques and receipts. Automatic date sequencing. Reconcile statements. Search, amend and delete. Analyze expenditure. Forward cash flow forecast. Budgets. Up to 36 bank accounts online, inter account transfers, 9999 standing orders, 99 analysis headings, over 4,000 postings on an 80tk diskette. Reports to screen or printer. Mix foreign currencies, graphics, password, file recovery, field editing, programmable reports.

**Master/Compact version** adds ADFS/hard disk support, sideways RAM, 40/80 col screen reports, and other enhancements.

**Archimedes /A3000** adds high speed native mode, RAM disks, wild card analysis enquiries, sort and more. *'Impressed...ideal...easy to use' Micro User March 88*

**Bank Manager (all versions; disk systems only) £25.00**

## BANK MANAGER BUSINESS UTILITY

For the club accounts or small business user. From the Bank Manager data files print "trial balance" or "P&L reports" via the programmable spreadsheet generator.

**Business Utility Pack (needs the Bank Manager) £12.00**

## TYPING TUTOR

Quickly learn to touch type. Over 90 smoothly graded lessons graduate you from the basic home keys to complete keyboard mastery. Word scan or exact key checking, targets may be revised, rhythm metronome, key click, free format options. Recommended for adult education.

**Typing Tutor £15.00**

## SPREADSHEET MK V

Low cost versatile spreadsheet. 26 cols, 900 (Arch/A3000) or 99 (B/Master) rows, many functions and facilities including programmable report writer and input scripts.

**Spreadsheet MK V disk £15.00**

**All programs available in B, Master/Compact and Archimedes/A3000 versions. Archimedes/A3000 versions are RISC OS compatible**

State type of computer (eg A3000, B, Master) and disk type (eg 3 1/2" or 5 1/4" 40 track or 5 1/4" 80 track). Please add £1 P&P (Overseas £3.50)

## CONTEX COMPUTING

(Ref MU), 15 Woodlands Close,  
Cople, Bedford MK44 3UE



Tel: 0234 838347

## DIAMOND-PUBLIC-DOMAIN

*For The Archimedes  
Over 290 Discs Available*

*Graphics-Utilities-Draw-Files-Sprites-Applications-SoundTracker  
Clip-Art-Sonix Super Sounds-Games & Demos*

**For First Class**



*Full Range of The Serial port  
Software/Hardware Available*

65watt Power Supplies  
Cased: 12 volt at 1.5amp  
Surge upto 2.5amps £29.50  
5volts at 3.75amps +£3.Del.

**And Same Day**



*Discs Are Priced AT £1.50 Each. This Includes Recorded Delivery & Package.  
For Catalogue/Demo Disc With Over 1300k Of Useful 'GOODIES' Send £1.50 To-*

*Mike Witkiss, 86 Meadowbank, Moor Lane, Holway,  
Holywell, CLWYD. CH8 7EF*

## SENLAC Computing Ltd. (Est 1988)

£ (ex VAT)		£ (ex VAT)	
Impression 2.....150.00 (127.66)	<b>Cash</b>	Micro Studio Graphics from...17.50 (14.89)	
Impression Junior.....81.00 (68.93)	<b>On</b>	Poster.....87.00 (74.04)	
FontFX.....9.50 (8.08)	<b>Delivery</b>	Pipedream 3.....138.00 (117.45)	
Scan-Light Plus Junior.....192.00 (163.40)	available on	Schema.....113.00 (96.17)	
Scan-Light Plus A4.....407.00 (346.38)	single	Rhapsody 2.....55.00 (38.30)	
with Sheet Feeder.....506.00 (430.64)	orders up to	Genesis 2.....138.00 (117.45)	
Laser-Direct.....1050.00 (893.62)	£350.00	Magpie.....56.00 (47.66)	
Laser-Direct Hi-Res.....1575.00 (1340.43)	value.	Revelation.....81.00 (68.94)	
ShowPage.....138.00 (117.45)	Only £2.50	Squirrel (v1.0).....123.00 (104.68)	
Equasor.....48.00 (40.85)	extra!	Multistore.....255.00 (217.02)	
ITracer.....57.00 (48.51)		Flexifile.....133.00 (113.19)	
Midnight Graphics Clip Art...34.00 (29.94)		MultiFS.....34.00 (28.94)	

**\*\*\* REMEMBER! Prices include VAT at 17 1/2%, postage and packing \*\*\***

Please make cheques/postal orders payable to **SENLAC Computing Ltd (MU).**

**P.O. Box 304, BRIGHTON, BN2 2TT**

We offer similar discounts across our whole range. Please send S.A.E for current price list.

VAT Reg. No. 508 7594 16

Company Registration No. 2277309

## !!!! EVERYTHING'S A BARGAIN !!!!

NO VAT INCREASES!!!

### T.M.J. Computer Software

39 Farmstead Road, Corby, Northants. NN18 0LE. Tel: 0536 69011

On Line BBS:DARKHAVEN 0604 413716

\*\*\* All prices are inclusive of VAT and POSTAGE \*\*\*

Product	Price	Product	Price
The Wimp Game.....£16.99		Micro Drive Extra Courses.....£12.95	
Iron Lord.....£16.99		Hostages.....£16.95	
Wonderland.....£29.99		Impression 2.....£160.95	
Nevryon.....£16.99		Arc Pinball.....£21.99	
Saloon Cars.....£19.99		Trivial Pursuit.....£23.75	
Chocks Away Version 2.....£19.99		Man. U. Football.....£20.99	
Chocks Away Extra Missions.....£16.99		Master Break.....£16.99	
E-Type.....£16.99		The Real McCoy.....£25.99	
Bughunter in Space.....£15.99		The Real McCoy 2.....£25.99	
Ball Arena.....£16.99		The Real McCoy 1&2.....£49.00	
Mig 29 Fulcrum.....£34.99		Boogie Buggy.....£19.99	
White Magic 2.....£16.99		Twin World.....£16.99	
Holed Out 1 & 2.....£14.99		Articulate.....£19.99	
Interdicator 2.....£29.95		World Championship Boxing Manager.....£21.99	
		PRES A3000 Monitor Stand.....£31.99	



Open Monday-Friday 9am-12noon & 1.30pm-6.30pm  
Saturday - 9.30am-1.30pm



## Advertisers' Index

4Mation.....	36
4th Dimension.....	22, 23, 46, IBC
Ace.....	86
Acorn User.....	52
AJL.....	111
AI Systems.....	65
Aleph One.....	55
Arcanyia.....	113
Atomwide.....	8
Automatic Services.....	110
Beebug.....	10, 12, 14
BV Computers.....	110
Chelsfield.....	66
Clares.....	59
Compuack.....	62
Computer Concepts.....	56
Computer Focus.....	98
Computer Tutorial.....	111
Computereyes.....	111
Contex.....	114
CSS Computer Centre.....	110
Dabhand.....	6, 7
Data Stream.....	113
Datatore.....	98
Diamond PD.....	114
Fact Systems.....	110
Gnome.....	66
Ground Control.....	98
Hex.....	43
Hi Voltage.....	20, 21
Ian Copestake Software.....	24, 31
Ifel.....	89
Indata.....	113
Integrex.....	35
Iota.....	103
Jaffa.....	98
JR Lectronics.....	111
Kendal Comp Centre.....	65
Krisalis.....	39
Le Computer.....	110
Micro Aid.....	113
Micromania.....	113
Micropower.....	45
Minerva.....	65
Morley.....	16, 17
Norwich Comp Services.....	86
Oak Solutions.....	3
Orion.....	48
Pineapple.....	51
Pres.....	33
Selective Services.....	111
Senlac.....	114
Shenley.....	113
Skyfall PD.....	113
Softshop.....	110
Superior.....	IFC, OBC
The Graphics Factory.....	66
TMJ.....	114
Voltmace.....	89
Watford.....	68, 69, 70, 71, 72, 73, 74, 75, 76, 77, 78, 79, 80, 81
We Serve.....	89
Wight Scientific.....	113
Yarm.....	111

# ARctist

# ARcticulate

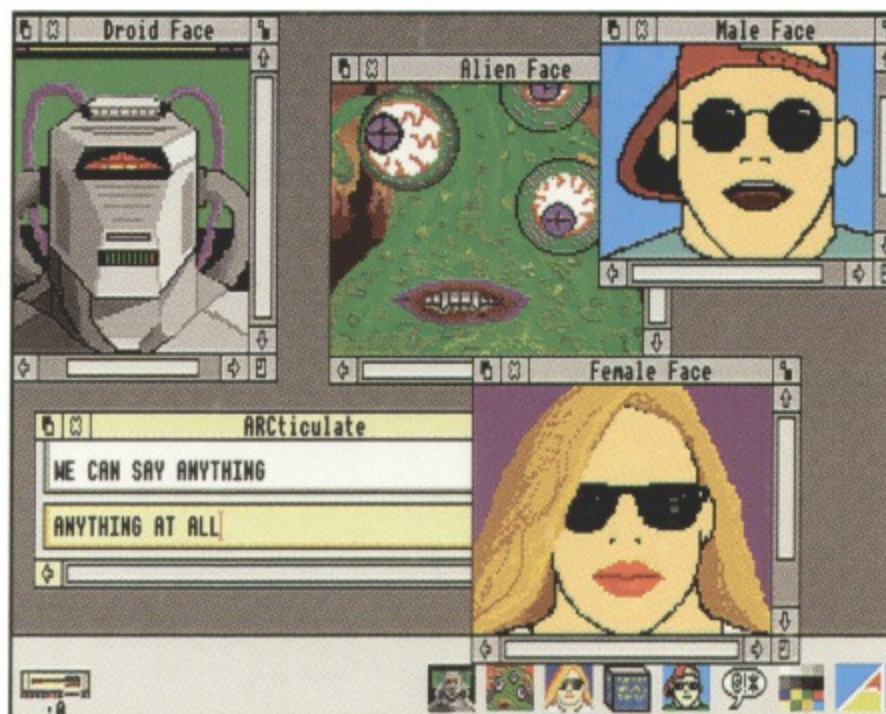

**"Anybody Can Be an Artist with ARctist"**

**"The Animated Speech Synthesizer"**

*This superb painting program has been designed to be incredibly easy to use and yet totally jam packed with features. Developed with help from educational specialists and professional graphic artists, ARctist is ideally suited to home, school and professional users.*

*This unique and revolutionary speech synthesizer actually has faces that talk to you and to each other. You can choose from 4 main faces and voices - male, female, alien or droid - thereby truly bringing your computer to life!*

Just a few of ARctist's features include:

- ✓ Full screen 256 colour mode 15 editing. RISC OS compatible.
- ✓ Intelligent spray gun that 'shades' rather than just plotting random 'dots' of colour.
- ✓ Rotation up to 2870% faster than IPaint.
- ✓ Internal handling of up to 30 sprites with auto sprite naming, sorting, grabbing, cutting, instant masking, rotation, scaling etc..
- ✓ Masking tape option lets you mask any part of the screen for spray gun work, then lift off later to reveal what was underneath.
- ✓ Zoom around the screen at high speed and edit with pixel accuracy.
- ✓ Several brush types available with variable size.
- ✓ Undo option undoes the last change you made to a drawing, in case of mistakes.
- ✓ Special effects to distort, detect edges, trace with colours, trace with sprites, swap colours, dither colours, blur, anti alias etc. etc..
- ✓ Special proportionally spaced outline fonts that don't require any memory in the font cache. Put a rectangle around the area you want the text to fit and ARctist will scale it to fit.
- ✓ Rectangle copy, move, rotate and scale. Also, accurate shape cut copy, move, rotate and scale tools to slice out the exact part of the screen you want.
- ✓ Sprite animation with built in sequence editor, offset generator and flight path editor.
- ✓ Load, edit and save fill pattern files. ARctist fill patterns are twice the size of normal ones.
- ✓ Two user definable drawing brushes, can be defined directly or grabbed from anywhere on the screen.
- ✓ Several hundred Kbytes of clip art included.

ARcticulate works in the desktop environment allowing full multi-tasking with word processors etc.. ARcticulate will read any documents that you have written or you can insert jokes, questions etc. etc.

You can alter the pitch, speed, volume and of course voice, during and after any sentence, thus allowing the faces to even talk to each other.

The Dictionary supplied is a RISCOS application and is simplicity itself to use. It holds up to 600 words in any file and you can have as many files as you wish - ideal for specialist subjects.

Also included in the package are a selection of jokes, some amusing noises to attach to desktop events, a provisional dictionary file and a superb demonstration program showing you just how articulate ARcticulate is!

### FACTFILE

- ✓ 4 animated faces able to cover all mouth positions
- ✓ 4 meticulously sampled voices which can say absolutely anything you want
- ✓ All faces and voices can be installed together
- ✓ An individual face and voice can be installed in less than 120K
- ✓ Very easy to use dictionary application with up to 600 words per file and limitless files
- ✓ Reads text files, word processor documents and can be easily used with your own programs
- ✓ Entertaining Joke program, Demo program and Funny Noises program also included

**BBC A3000 & ARCHIMEDES PRICE £24.95**

"ARctist" is compatible with the BBC A3000 and 310 & 400 Series

**BBC A3000 & ARCHIMEDES PRICE £24.95**

"ARcticulate" is compatible with the BBC A3000 and 310 & 400 Series

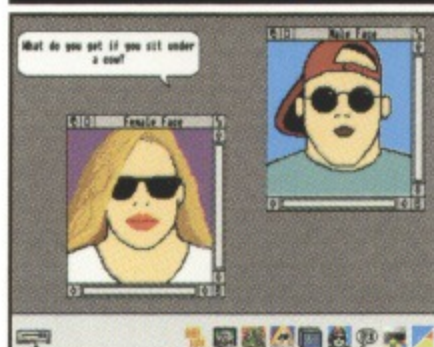

### DEALERS

Most of our software is available from most good dealers. If they don't stock them, then please give them a copy of this advert & tell them they can easily buy them directly from us.

**SUPERFAST 1st Class FREE Delivery**

### LETTER

Simply send us a quick letter telling us the software you require, your name and address, and payment via cheque, postal order or ACCESS or VISA card details  
**The Fourth Dimension, 1 Percy Street, Sheffield, S3 8AU, England.**

All orders are despatched immediately by 1st Class post. Carriage is paid by us in the U.K. (Overseas orders add £3 per product).

FULL DETAILS OF ALL OUR GAMES ARE AVAILABLE ON REQUEST & ARE SENT WITH ALL ORDERS.

### TELEPHONE

TELEPHONE ORDERS WELCOME  
**(0742) 700661 / 769950**  
 ACCESS & VISA Accepted  
 24 hour Service 7 Days a Week

### THE FOURTH DIMENSION

1 Percy Street  
 Sheffield  
 S3 8AU  
 England  
 Tel. (0742) 700661  
 or 769950

# A3000/ARCHIMEDES TITLES FROM SUPERIOR SOFTWARE



## SPEECH!

Give your computer a voice with this high quality speech synthesiser, which is both easy to use and very flexible. It can directly speak words you input or text files, or you can use phonetic input to add stress/intonation, speak foreign languages or even sing! The program is RISC OS compatible and allows multi-tasking in Desktop. An easily modified spelling program is included.

"This is by far the best software I have seen this year...you can actually understand what the machine is saying"...BBC Acorn User

£19.95



## MASTER BREAK

A snooker-style trivia quiz for 1 to 4 players. Over 2000 questions on SCIENCE & NATURE, POP MUSIC, GEOGRAPHY, SPORTS & PASTIMES, ARTS and HISTORY. Digitised pictures include: sport and pop stars, famous places, animals and world leaders. Amusing and educational. Can you get the maximum break of 147?

"The digitised pictures and sounds are very nice indeed. The timer really adds atmosphere - I panicked the first time I tried to answer a black question...it's good to play on your own or with friends"...Micro User

£19.95



## SUPERIOR GOLF plus CONSTRUCTION SET

The complete golfing game for 1 to 4 players, designed exclusively for the ARCHIMEDES. Realistic gameplay with a choice of six courses (St Andrews, The Belfry, Victoria and three Sea Palms courses), plus Driving Range and Practice Green. Full feature hole and course design and editing facilities.

"Technically brilliant, graphically excellent and incredibly playable. Worth going a fairway to buy"...A & B Computing (now Archimedes World)

£19.95



## ZARCH

David Braben, co-author of ELITE, has harnessed the speed and performance of the ARCHIMEDES to create a programming masterpiece. Realistic 3-dimensional landscapes, with area shading and accurate perspective drawing, unsurpassed in any other home computer game, plus nerve-tingling gameplay. Totally addictive.

"Graphics ★★★★★ Addictiveness ★★★★★ Value for money ★★★★★. If you haven't already bought this game, then make a point of doing so"...BBC Acorn User

£19.95



## CONQUEROR

Step into a tank of your choice and experience the thrill of controlling one of the most powerful land vehicles in the world, in a 3-dimensional landscape of roads, hills, villages, rivers and woodland. Choose the Arcade or Attrition games to develop your skills, and then ultimately the Strategy game, a full battle simulation with up to 16 tanks per side from American, German or Russian forces

"What I want is a thinking man's shoot-em-up like ELITE - and CONQUEROR fits that bill"...Micro User

£24.95



## HOSTAGES

The highly acclaimed, top-hit ATARI/AMIGA game, now reaches the ARCHIMEDES. Commando action and strategic planning as you rescue the hostages from the besieged embassy. Brilliant, realistic graphics and exciting gameplay...superb digitised sound effects and tunes...keyboard or mouse control.

"Graphically the game is very nice indeed. Your men run around, jump, leap, roll and die with great aplomb and the animation of them is excellent"...A & B Computing (now Archimedes World)

£19.95



## REPTON 3

Four of the most popular strategy games ever produced for Acorn computers in one great value-for-money package. Four complete Repton games - REPTON 3, AROUND THE WORLD IN 40 SCREENS, THE LIFE OF REPTON and REPTON THRU TIME - with choice of four tunes and a position Save/Recall facility, plus easy-to-use screen and character design and editing facilities. Now with superb enhanced graphics produced by the winner of the Design-a-Screen competition. Suitable for all ages from 5 to 105!

£19.95



## AIR SUPREMACY

In this totally new type of game/simulation, you can choose to swap between aircraft and ground or sea combat forces, as the battle develops. You start in 1918 in Europe, with biplanes and tanks, then proceed to level 2 in 1944 in the Pacific, with fighter aircraft and gunboats. Level 3 in 1991 involves jet aircraft and desert tanks, and finally to 2150 with futuristic aircraft and rapid attack hovercraft. As you progress, the action becomes faster and more difficult with the ordnance increasingly comprehensive.

Available Autumn 1991



ACORNSOFT

(Superior Software is a trading name of Superior Microcomputing Ltd.)  
Dept. 11, P.O. Box 6, Brigg, S. Humberside DN20 9NH. Tel: (0652) 58585

PLEASE MAKE CHEQUES  
PAYABLE TO "SUPERIOR SOFTWARE."



24 HOUR TELEPHONE  
ANSWERING SERVICE FOR ORDERS

### OUR GUARANTEE

- All mail orders are despatched by first-class post
- Postage and packing is free
- Cassettes and disks that are faulty on receipt will be replaced immediately

(This does not affect your statutory rights)

# MEDES TITLES FROM R SOFTWARE

is high  
both easy to  
speak  
you can use  
on, speak  
program is  
multi-tasking in  
program is

ve seen this  
what the  
r

£19.95

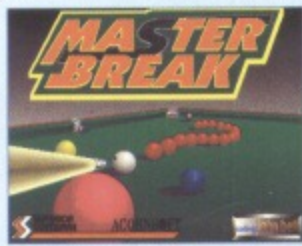

## MASTER BREAK

A snooker-style trivia quiz for 1 to 4 players. Over 2000 questions on SCIENCE & NATURE, POP MUSIC, GEOGRAPHY, SPORTS & PASTIMES, ARTS and HISTORY. Digitised pictures include: sport and pop stars, famous places, animals and world leaders. Amusing and educational. Can you get the maximum break of 147?

"The digitised pictures and sounds are very nice indeed. The timer really adds atmosphere - I panicked the first time I tried to answer a black question...it's good to play on your own or with friends"...Micro User

£19.95



## ZARCH

David Braben, co-author of ELITE, has harnessed the speed and performance of the ARCHIMEDES to create a programming masterpiece. Realistic 3-dimensional landscapes, with area shading and accurate perspective drawing, unsurpassed in any other home computer game, plus nerve-tingling gameplay. Totally addictive.

"Graphics ★★★★★ Addictiveness ★★★★★ Value for money ★★★★★. If you haven't already bought this game, then make a point of doing so"...BBC Acorn User

£19.95



4 players,  
MEDES.

six courses  
d three Sea  
and Practice  
design and

cellent and  
fairway to  
medes

£19.95

experience  
ost powerful  
imensional  
ivers and  
Attrition  
hen  
battle  
side from  
s  
hoot-em-up  
that bill"

£24.95



## HOSTAGES

The highly acclaimed, top-hit ATARI/AMIGA game, now reaches the ARCHIMEDES. Commando action and strategic planning as you rescue the hostages from the besieged embassy. Brilliant, realistic graphics and exciting gameplay...superb digitised sound effects and tunes...keyboard or mouse control.

"Graphically the game is very nice indeed. Your men run around, jump, leap, roll and die with great aplomb and the animation of them is excellent"...A & B Computing (now Archimedes World)

£19.95



games ever  
ne great  
mplete  
ND THE  
E OF  
- with  
Save/Recall  
d character  
with superb  
e winner of  
uitable for

£19.95



## AIR SUPREMACY

In this totally new type of game/simulation, you can choose to swap between aircraft and ground or sea combat forces, as the battle develops. You start in 1918 in Europe, with biplanes and tanks, then proceed to level 2 in 1944 in the Pacific, with fighter aircraft and gunboats. Level 3 in 1991 involves jet aircraft and desert tanks, and finally to 2150 with futuristic aircraft and rapid attack hovercraft. As you progress, the action becomes faster and more difficult with the ordnance increasingly comprehensive.

Available Autumn 1991

PLEASE MAKE CHEQUES  
PAYABLE TO "SUPERIOR SOFTWARE."



24 HOUR TELEPHONE  
ANSWERING SERVICE FOR ORDERS

### OUR GUARANTEE

- All mail orders are despatched by first-class post
- Postage and packing is free
- Cassettes and disks that are faulty on receipt will be replaced immediately

(This does not affect your statutory rights)

SOFT

uting Ltd.)  
552) 58585

THE MICRO USER

# THE MICRO USER

Volume 9

Number 7

September 1991

September

## SOFTWARE BREAKTHROUGH

Program  
compatibility  
is now a  
reality



9 770265 404004

09

Vol. 9 No. 7

For ALL users of the BBC Micro